



Zubehör für Arbeitsscheinwerfer

Accessories for Work Lamps



Glühlampen vom Lichtexperten Hella Bulbs from the lighting specialist Hella



DIN Form		Volt	Watt	Socket	DIN Form		Volt	Watt	Socket
ECE category		voltage	wattage	base	ECE category		voltage	wattage	base
H3	8GH 002 090-271	12	35	PK22s	HB3	8GH 005 635-121	12	60	P20d
H3	8GH 002 090-133	12	55	PK22s	H9	8GH 008 357-001	12	65	PG319-5
H3 LL	8GH 002 090-111	12	55	PK22s	H11	8GH 008 358-121	12	55	PGJ 19-2
H3 HD	auf Anfrage / on request	12	55	PK22s	H11	auf Anfrage / on request	24	70	PGJ 19-2
H3	8GH 002 090-151	12	100	PK22s	GE885	8GH 990 313-001	12	50	
H3	8GH 002 090-251	24	70	PK22s	GE886	8GH 007 008-121	12	50	
H4	1GJ 002 525-131	12	60/55		GE894	auf Anfrage / on request	12	37,5	
H4	1GJ 002 525-251	24	75/70		D1S	8GS 990 332-001		35	PK32d-2
H7	8GH 007 157-121	12	55	PX26d	D2S	8GS 007 949-101		35	P32d-2
H7 LL	8GH 007 157-201	12	55	PX26d	W3W	8GP 003 594-141	12	3	W2,1x9,5d
H7	8GH 007 157-241	24	70	PX26d	P21W	8GA 002 073-121	12	21	BA15s

Schutzkappen und Tüllen von Hella Protective caps and grommets from Hella

Gummikappen schützen die Steckerkontakte vor Feuchtigkeit und Eindringen von Staub und Schmutz.
Rubber caps protect connector terminals from humidity and penetration of dirt and dust.



DEUTSCH 4-polig 4-pole	DEUTSCH 6-polig 6-pole	AMP 2-polig 2-pole	AMP 4-polig 4-pole	AMP 90° 6-polig 6-pole	DEUTSCH 90° 6-polig 6-pole	H9 2-polig 2-pole	H9 Oval 100	Tülle/grommet A Tülle/grommet B
------------------------------	------------------------------	--------------------------	--------------------------	------------------------------	----------------------------------	-------------------------	----------------	------------------------------------

Pole/Poles			Pole/Poles		
Kappe für DEUTSCH Stecker / cap for DEUTSCH plug	2	9GH 990 316-021	Kappe für AMP 90° Stecker / cap for AMP 90° plug	6	9GH 993 988-007
Kappe für DEUTSCH Stecker / cap for DEUTSCH plug	4	9GH 990 316-001	Kappe für DEUTSCH 90° Stecker / cap for DEUTSCH plug 90°	6	9GH 990 316-031
Kappe für DEUTSCH Stecker / cap for DEUTSCH plug	6	9GH 990 316-011	Kappe für H9 90° Stecker (nur für Ultra Beam) / cap for H9 plug 90° (Ultra Beam only)	2	9GH 990 334-001
Kappe für AMP Stecker / cap for AMP plug	2	9GH 993 984-001	Kappe H9 (nur Oval 100) / cap H9 (Oval 100 only)	2	9GH 990 334-011
Kappe für AMP Stecker / cap for AMP plug	4	9GH 990 310-001	Tülle A für Drehfußgehäuse / grommet A for housing with rotary pivot base	-	9GT 990 234-007
			Tülle B für Kabeleinführung (Ultra Beam) / grommet B for cable entrance (Ultra Beam)	-	9GT 990 166-007

Staubkappen für Modul 164x103 und 6213/6214 Dust caps for series 164x103 and 6213/6214

Staubkappen schützen das Gerät vor Eindringen von Feuchtigkeit und vor Verschmutzung
Dust caps protect the lamp against ingress of humidity and dirt.



Typ / Type		Typ / Type	
A für / for 164x103	9GH 126 647-005	1 (6213/6214 und / and Multi Beam)	9HD 990 044-001
B für / for 164x103	9GH 122 662-007	2 (6213/6214 und / and Multi Beam)	9GH 122 662-001
C für / for 164x103	9GH 126 647-011	3 (6213/6214 und / and Multi Beam)	9GH 116 966-011
D für / for 164x103	9HD 990 059-001	4 (für Modul 90 / for module 90)	9GH 152 654-007

Stecker und Lampengegenstecker Plugs and lamp mating plugs

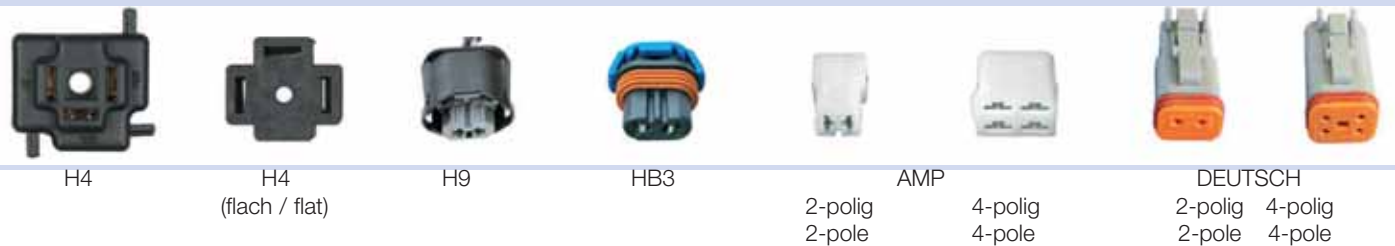

Stecker / Plug		Stecker / Plug	
Für H4 Lampe 3-polig For H4 bulb 3-pole	8JA 001 909-001	AMP 2-polig (VPE 20 Stück) AMP 2-pole (packaging unit 20 pieces)	8JA 990 295-027
Für H4 Lampe 3-polig (flach) For H4 bulb 3-pole (flat)	8JA 990 065-001	AMP 4-polig (VPE 20 Stück) AMP 4-pole (packaging unit 20 pieces)	8JA 990 295-007
H9 (VPE 20 Stück) H9 (packaging unit 20 pieces)	2JD 158 175-807	DEUTSCH 2-polig (VPE 10 Stück) DEUTSCH 2-pole (packaging unit 10 pieces)	8JA 990 295-127
HB3	8JA 990 295-217	DEUTSCH 4-polig DEUTSCH 4-pole	auf Anfrage / on request

Leitungsgruppen mit div. Steckanschlüssen Wire harnesses with various plug-in connectors

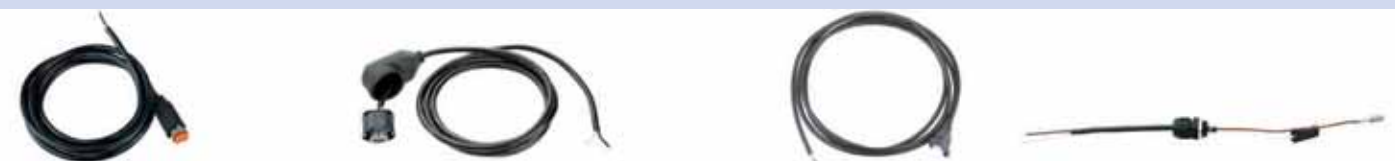

DEUTSCH
(2 m)

H9
(2 m)

AMP
(2 m)

PG-Verschraubung, Länge 15 cm
(Upgrade für Tüllenversionen)
Threaded gland with nut, length 15 cm
(upgrade for grommet versions)

Steckanschlüsse / connectors		Steckanschlüsse / connectors	
AMP	8KB 990 299-001	H9 (nur Modul 70 H9) H9 (Modul 70 H9 only)	auf Anfrage / on request
DEUTSCH	8KB 990 299-011	H9 (nur Ultra Beam H9) H9 (Ultra Beam H9 only)	8KB 990 299-141
H9 (nur Oval 100 H9) H9 (Oval 100 H9 only)	8KB 990 299-131	PG-Leitungsgruppe / threaded gland with nut wire harness	8KB 990 299-501



Leitungsgruppe mit PG-Verschraubung für Standardarbeitsscheinwerfer mit Tülle, Länge 150 mm, mit Flachstecker innen und losen Kabelenden außen

Wire harness with threaded gland with nut for standard work lamps with grommet, length 150 mm, with flat plugs for inside and loose connection leads on the outside

8KB 990 299-501

Leitungsgruppen für Xenon Arbeitsscheinwerfer Wire harnesses for HID work lamps



für Xenon-Vorschaltgeräte
3. oder 4. Generation
for HID ballast units
of 3rd or 4th generation



Oval 100
4. Gen.



Ultra Beam
4. Gen.



Modul 70 / module 70
4. Gen.

Xenon Leitungsgruppen für alle Xenon Arbeitsscheinwerfer (zw. Vorschaltgerät und Batterie) Xenon wire harnesses for all HID work lamps (between ballast unit and battery)	
Xenon 3. Gen. (12V)	8KB 149 147-001
Xenon 3. Gen. (24V)	8KB 150 980-001
Xenon 4. Gen. (12V, 3,1 m)	8KB 990 299-221
Xenon 4. Gen. (24V, 3,1 m)	8KB 990 299-231

Xenon Leitungsgruppen Oval 100 (zw. Vorschaltgerät und Arbeitsscheinwerfer) HID wire harness Oval 100 (between ballast unit and work lamp)	
1 m	auf Anfrage / on request
3 m	auf Anfrage / on request

Xenon Leitungsgruppe Ultra Beam HID wire harness Ultra Beam	auf Anfrage / on request
--	-----------------------------

Xenon Leitungsgruppe M70 HID wire harness M70	auf Anfrage / on request
--	-----------------------------

Xenon Elektronik HID ballast unit



Elektronik 3. Generation
HID ballast unit 3rd gen.



Schutzgehäuse (3.Gen.)
protective housing (3rd gen.)



Halter mit Dichtung (3. Gen.)
holder for control unit
with gasket (3rd gen.)



Elektronik 4. Generation
electronics 4th gen.

Xenon Vorschaltgeräte 3. Generation, 12V HID ballast unit 3 rd gen., 12V	5DV 007 760-471	Halter für Vorschaltgeräte 3. Generation mit Dichtung bracket for HID ballast unit 3 rd generation with sealing	9XD 990 308-001
Xenon Vorschaltgeräte 3. Generation, 24V HID ballast unit 3 rd gen., 24V	5DV 007 810-171	Halter für Vorschaltgeräte 3. Generation ohne Dichtung bracket for HID ballast unit 3 rd generation without sealing	8HG 151 866-001
Schutzgehäuse für 3. Generation, 12V protecting housing for 3 rd gen. ballast unit, 12V	9BG 990 297-001	Xenon Vorschaltgeräte 4. Generation, 12V HID ballast unit 4 th gen., 12V	5DV 008 855-001
Schutzgehäuse für 3. Generation, 24V protecting housing for 3 rd gen. ballast unit, 24V	8KB 990 297-011	Xenon Vorschaltgeräte 4. Generation, 24V HID ballast unit 4 th gen., 24V	5DV 008 856-001

Elektronik 1+1 (Mining) Electronics 1+1 (for mining)

Passend für Oval 100 Double Beam. Für alle übrigen „Double Beam“ Arbeitsscheinwerfer (Double Beam, Picador) auf Anfrage.

Suitable for Oval 100 double beam. For all other double beam work lamps (Double Beam, Picador) on request



Die Umschaltelektronik 1+1 für Double Beam-Geräte ist so konzipiert, dass automatisch bei Ausfall der Glühlampe sofort auf die zweite Glühlampe umgeschaltet wird. Erhöhte Sicherheit und reduzierte Maschinenausfallzeiten sind garantiert.

The 1+1 switch-over system for double beam work lamps enables the automatic switch over to the second bulb when the first filament fails. Reduced machine downtime and increased safety are guaranteed.

Elektronik 1+1 12V
Electronics 1+1 for 12V

auf Anfrage / on request

Elektronik 1+1 24V
Electronics 1+1 for 24V

auf Anfrage / on request

Abdeckungen zum Schutz der Lichtscheibe Protective covers for protecting the glass lens



Acryl Abdeckung passend für Acrylic protective cover to suit	Farbe colour	
AS200 Xenon	klar / clear	auf Anfrage / on request
AS200 Xenon	orange / amber	auf Anfrage / on request
Ultra Beam Xenon	klar / clear	auf Anfrage / on request
Ultra Beam Xenon	orange / amber	auf Anfrage / on request
Ultra Beam Halogen	klar / clear	auf Anfrage / on request
Ultra Beam Halogen	orange / amber	auf Anfrage / on request
Oval 100 Halogen	klar / clear	auf Anfrage / on request
Oval 100 Halogen	orange / amber	auf Anfrage / on request

Montagehilfen Mounting aids



Rohrbefestigung pipe mount	Spiegelbefestigung mirror mount	Deckel cover for Ultra Beam	Einbaumulde built-in bracket for Ultra Beam	Adapter adapter 6214/Oval 100	Einbaurahmen Mounting frame Oval 120
-------------------------------	------------------------------------	-----------------------------------	---	-------------------------------------	--

Rohrbefestigung drehbar pipe mount rotatable	8HG 990 263-101	Adapter 6214 zu Oval 100, schwarz adapter 6214 to Oval 100, black	9AH 990 350-021
Halter für Spiegelstange Ø max. 25,5 mm, Lochabstand 36 mm bracket for mirror rod,	8HG 990 263-001	Adapter 6214 zu Oval 100 mit Blendschutz, nur für Arbeitsscheinwerfer adapter 6214 to Oval 100 with glare protec- tion for work lamps only	auf Anfrage on request
Blinddeckel / blind cover Ultra Beam	9HD 990 053-007	Adapter 6214 zu Oval 100 in anderen Farben adapter 6214 to Oval 100 in other colours	auf Anfrage on request
Einbaumulde / built-in frame Ultra Beam	9HD 990 053-007	Einbaurahmen für Oval 120 mounting frame for Oval 120	9AH 990 347-001

Adapter 6213/6214 – Oval 100 für frisches Design Adapter 6213/6214 - Oval 100 for a new design



passend für Haupt- und
Arbeitsscheinwerfer
suitable for head- and
work lamp

Adapter 9AH 990 350-201
Oval 100

Aufsteckrohre und Stative Ø 24mm Pipe sockets and tripods Ø 24mm



Adapter Rohrbefestigung
adapter pipe fitting

A

B

C

D

E

F

G

H

I

J

K

L

Adapter für Aufsteckrohr zur Kombination mit Aufsteckrohren 8HG 002 365-001 und 8HG 006 294... bracket pipe socket fitting for combination with pipe sockets 8HG 002 365-001 and 8HG 006 294...	8GH 990 320-001	E) schwenkbar, zum Anschrauben an ein flaches Kabinendach (oben bzw. seitlich) swivelling holder for screwing onto horizontal and vertical cabin roofs	8HG 006 294-031
Universelle Rohrbefestigung zur Montage auf Ø 24mm Aufsteckrohr Universal pipe fitting for mouting on Ø 24mm pipe socket	9XD 990 097-007	F) Winkelrohrbefestigung, zum Anschrauben an senkrechte Fahrzeugflächen (seitlich) holder for screwing onto vertical cabin roofs (on side)	9XD 990 284-001
A) Aufsteckrohr mit 1-poliger Messingsteckdose DIN 72591 pipe socket with 1-pole built-in electrical socket to DIN 72591	8HG 002 365-001	G) Stativhalter zum Anschrauben an die Kabinenrückseite, Länge 1000 mm Telescopic holder for screwing onto back of cabin roof, length 1000 mm	8HG 006 294-041
A) Aufsteckrohr mit separatem Masseanschluss pipe socket with extra earth contact	8HG 006 294-101	H) Gelenkstück-/Reduzierstück, mit Aufsteckzapfen Ø 24 mm, passt auf Aufsteckzapfen Ø 30 mm, schwenkbar um 180°, mit Handgriff arretierbar / joint/reducer, with 24 mm dia. attachment pin and suitable for 30 mm dia. attachment sleeve, 180° swivable, with arresting device through handle	9XS 027 639-001
B) mit Schraubbefestigung und 1-poliger Steckdose with screw fixing and 1-pole socket	8HG 006 294-051	I) Universal Halter, passt für Aufsteckzapfen Ø 30 mm universal holder, suitable for 30 mm dia. attachment sleeve	8HG 159 455-001
B) mit Schraubbefestigung und separatem Masseanschluß with screw fixing and extra earth contact	8HG 006 294-091	J) Sockel zur Montage auf dem Fahrzeugdach oder anderen waagerechten Flächen, mit Aufsteckzapfen Ø 30 mm socket for mounting on vehicle roof or other horizontal body surface, with 30 mm dia. attachment pin	8XT 002 121-001
C) zum Anschrauben auf ein flaches Kabinendach (oben) mit Langlöchern for screwing onto horizontal cabin roofs (on top) with oblong holes	8HG 006 294-011	K) Aufsteckrohr Ø 24 mm, Länge 220 mm, Chrom6+-frei Attachment pipe 24 mm dia., length 220 mm, chromium-6 free	8HG 990 368-007
D) zum Anschrauben auf ein flaches Kabinendach (seitlich) mit 90° Anbauwinkel und Langlöchern for screwing onto horizontal cabin roofs (on side) with angle 90° and oblong holes	8HG 006 294-021	L) Stahlrohrstativ, ausziehbar von 1051 bis 1650 mm, Aufsteckzapfen Ø 30 mm / tubular steel tripod, extends from 1051 to 1650 mm. 30 mm dia. attachment pin	8XT 002 117-001

Dazupassendes Set bestehend aus Arbeitsscheinwerfer Mega Beam und Rundumkennleuchte
Suitable set consisting of Mega Beam work lamp and rotating beacon



Mega Beam Arbeitsscheinwerfer (1GM 996 134-641), Rotafix Rundumkennleuchte (2RL 006 846-001)inkl. Ersatzleuchtmittel (12/24V H3 und H1) und Kunststoffkoffer Mega Beam Work Lamp (1GM 996 134-641), Rotafix rotating beacon (2RL 006 846-001) including spare bulbs (12/24V H3 and H1) and plastic case	9Z2 996 178-001
Weitere Varianten auf Anfrage Further versions on request	

Schrauben für Serie 164x103 Screws for series 164x103



Festpunkt
Fixed point

Klammer
bracket

Einstellschraube
adjusting screw

Kugelpfanne
ball socket

Einstellschraube M6
adjusting screw M6

Festpunkt Serie 006 277 Fixed point series 006 277	9NS 140 046-005	Kugelpfanne Serie 996 025 Ball socket series 996 025	9XD 990 060-007
Klammer Serie 006 277 Bracket series 006 277	9KX 143 492-005	Einstellschraube M6 Serie 996 025 Adjusting screw M6 series 996025	9XX 996 067-081
Einstellschraube Serie 006 277 Adjusting screw series 006 277	9NS 140 045-005		

Universalhalter und Bügel Universal fixings and brackets

Für Serien Oval 100, Ultra Beam, Mega Beam, AS 200 und Double Beam
For series Oval 100, Ultra Beam, Mega Beam, AS 200 and Double Beam

Halter in besonderer Qualität
Mounting brackets in special quality



Halter in Standardqualität
Mounting brackets in standard quality

Standardfuß 4-Punkt Niro
Bracket, 4 point mounting, stainless steel
9XD 990 298-011
8HG 998 521-001(Marine)

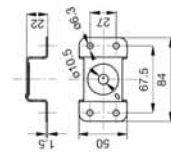

Magnethalterung 2 Stück inkl.
Befestigungsmaterial
magnetic base, 2 pcs. incl. screws
8HG 004 806-001
passend zu Bügel / suitable for bracket
9XD 130 261-001



Befestigungswinkel Niro mit Langlöchern (für
Magnethalterung)
Bracket stainless steel with oblong holes (for
magnetic bases)
9XD 130 261-001

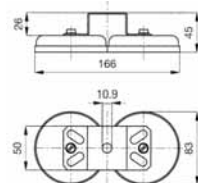

Standardfuß groß, 4-Punkt
Standard bracket large, 4 point mounting
8HG 990 001-001

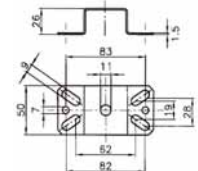

Standardfuß klein, 4-Punkt
Standard bracket small, 4 point mounting
9XD 990 298-001

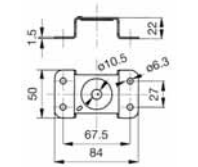
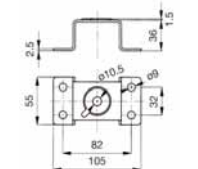

Universalhalter und Bügel Universal fixings and brackets

Für Serien Oval 100, Ultra Beam, Mega Beam, AS 200 und Double Beam
For series Oval 100, Ultra Beam, Mega Beam, AS 200 and Double Beam



Montagewinkel
Bracket for wall mounting
9HG 990 004-001



Montagefuß 842, 2-Punkt
Attachment bracket 842, 2 point mount
auf Anfrage / on request



Verstärkter Standardbügel 890
Re-inforced standard bracket 890
auf Anfrage / on request



Bügel 768 für Xenon Geräte der Serien
Bracket 768 for HID work lamps series
Ultra Beam, Mega Beam, Oval 100, AS 200
auf Anfrage / on request



Bügelgruppe für horizontale Schwenkbarkeit
(+/-45°) für Serien
Attachment bracket for horizontal swivelling
for series, Ultra Beam, Mega Beam, Oval
100, AS 200, 9XD 990 329-011

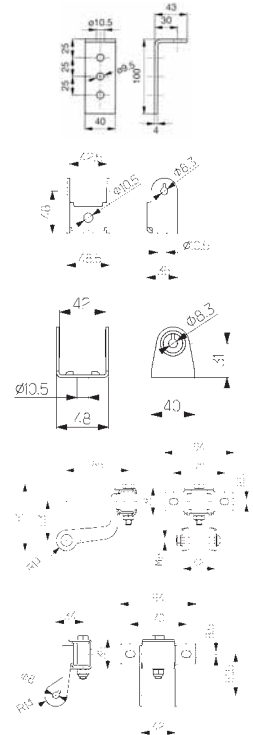

Für Serien Picador und Modul 70 For series Picador and Module 70

Halter in besonderer Qualität
Mounting brackets in special quality



Standardfuß 2-Punkt Niro, schmal,
Standard bracket narrow, stainless steel
8HG 992 868-021 (Marine)

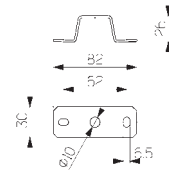

Halter in Standardqualität
Mounting brackets in standard quality

Für Serie Master For series Master



Bügel 390 mit Schraube M10x70
Bracket 390 with screw M10x70
auf Anfrage / on request

Lochabstand /
distance between holes
36 mm



Bügel 571
Bracket 571
auf Anfrage / on request

Lochabstand /
distance between holes
36 mm

Universalhalter und Bügel
Universal fixings and brackets



Bügel 34103 Bracket 34103 auf Anfrage / on request	Lochabstand / distance between holes 36 mm
Bügel 584, schwarz Bracket 584, black auf Anfrage / on request	Lochabstand / distance between holes 36 mm Höhe / height 38 mm, Ø 10,2 mm
Bügel 341, schwarz Bracket 341, black auf Anfrage / on request	Lochabstand / distance between holes 36 mm Höhe / height 20 mm, Ø 10,2 mm
Bügel 39 schwarz mit Schraube M8x25 Bracket 39 black with screw M8x25 auf Anfrage / on request	Lochabstand / distance between holes 36 mm Höhe / height 20 mm
Bügel 743, schwarz Bracket 743, black auf Anfrage / on request	Lochabstand / distance between holes 36 mm
Bügel 437, schwarz Bracket 437, black auf Anfrage / on request	Lochabstand / distance between holes 36 mm
Bügel 399 Bracket 399 auf Anfrage / on request	Lochabstand / distance between holes 36 mm

Doppelbügel passend für Ultra Beam, Picador, Mega Beam und Oval 100 mit Drehfußgehäuse
Double bracket suitable for series Ultra Beam, Picador, Mega Beam and Oval 100 with rotary pivot base housing



Bügel 890 Bracket 890 auf Anfrage / on request	Lochabstand / distance between holes 33 mm, Höhe / height 39 mm, Ø 10,2 mm
Bügel 455 Bracket 455 auf Anfrage / on request	Lochabstand / distance between holes 33 mm, Ø 10,2 mm

Bügel passend zu AS 300, AS 400 und AS 500
Bracket suitable for AS 300, AS 400 and AS 500



Doppelbügel
Double bracket
auf Anfrage/on request

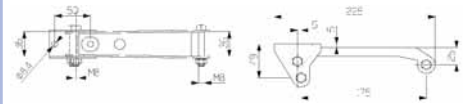

Universalhalter und Bügel Universal fixings and brackets



Standardbügel, Heavy Duty, Niro,
Standard bracket, heavy duty, stainless steel,
8HG 990 380-001

Heavy Duty U-Bügel (Niro)
heavy duty u-bracket, stainless steel,
8HG 990 381-001

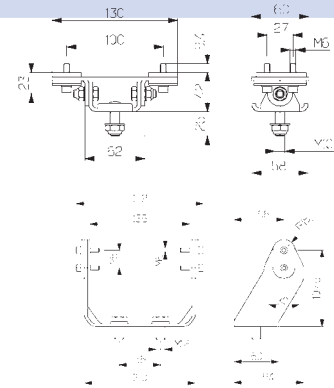

AS 300, AS 400



AS 500 Mining mit Heavy-Duty U-Bügel
AS 500 mining with heavy duty u-bracket

Universal Funkschaltungssystem Universal radio remote control



Bis zu 2 Scheinwerfer mit je max. 110 W lassen sich bequem von ausserhalb des Fahrzeuges per handlicher Funkfernbedienung ein- und ausschalten (auch für Xenon Scheinwerfer geeignet). Wechselcode schließt eine Beeinflußung anderer ferngesteuerte Geräte aus, mit CE und Funkschutzzeichen, ECE-tüvgeprüft.

Switches up to 2 lamps with max. 110W conveniently from outside the vehicle using the handy radio remote control unit (also suitable for Xenon lamps), charging code prevents external influence through other remote-controlled devices, with CE mark, ECE approval and radio disturbance suppression mark.

Mobiler Funksender mit Kontroll-LED zur Ein- und Ausschaltkontrolle,
Zentralsteuereinheit und vorkonfektionierter Profi-Kabelsatz
Mobil radio transmitter with control LED for on/off control, central control
unit and pre-assembled professional cable harness

12 V

6ZN 160 705-001

24 V

6ZN 160 705-011

Hella Fahrzeugteile Austria GmbH
Target Group Land-, Baumaschinen und Spezialfahrzeuge
Target Group Agricultural, Construction and Utility Machinery
A-1100 Wien, Hebbelplatz 5
Tel.: +43(1)6068920, Fax: +43(1)6068920-216
Internet: www.hellaagro.com, E-Mail: info-ag-ce@hella.at

