



BRIEF INFORMATION

HypaLUME 110 / 230V AC LED Flood Light – Heavy Duty

PRODUCT FEATURES

The 110/230 V AC HypaLUME has been designed for applications where high output lighting in extreme environments is required. The lamp produces a net output of 28,000 lumens at a voltage input range of 100–240 V AC whilst only consuming 300 W.

Comprehensive sealing and anti-corrosion measures have been taken to ensure this lamp withstands the toughest conditions. The premium aluminium housing is corrosion resistant with a non-stick and easy to clean surface coating. Heavy duty Grilamid® lens offers unbeatable toughness against impacts and vibration while providing long term UV stability and resistance to commonly used chemicals for the life of the product. The LEDs have a colour temperature of 5700 K to provide a near daylight work environment that is optimal for fatigue avoidance and high alertness.

The LED driver electronics ensure light output remains stable over a wide range of voltage variations. The HypaLUME is also protected from over voltage and short circuit faults. The HypaLUME is designed to operate over a temperature range from -40 °C to +50 °C.

TECHNICAL DETAILS

Technical data

Operating voltage range	Multi-voltage (100–240 V)
Rated voltage	110 V and 230 V
Power consumption	Max. 300 W
Light output (warm)	28,000 lm
Colour temperature	5,700 K
Material	Lens: High impact and chemical resistant Grilamid® lens Bracket: stainless steel
Temperature range	-40 °C to +50 °C
Protection class	IP 66, IP 67
Compliant	IEC 60598, EN 55015
Protection	Overvoltage protection (up to 305 V for 30 sec), short circuit and over temperature protection
Mounting	Upright or pendant
Connection	Heavy duty, Wieland RST Mini – 16 A, with 2 m of easy plug-in sheathed cable
Manufactured in	New Zealand

Dimensional sketch

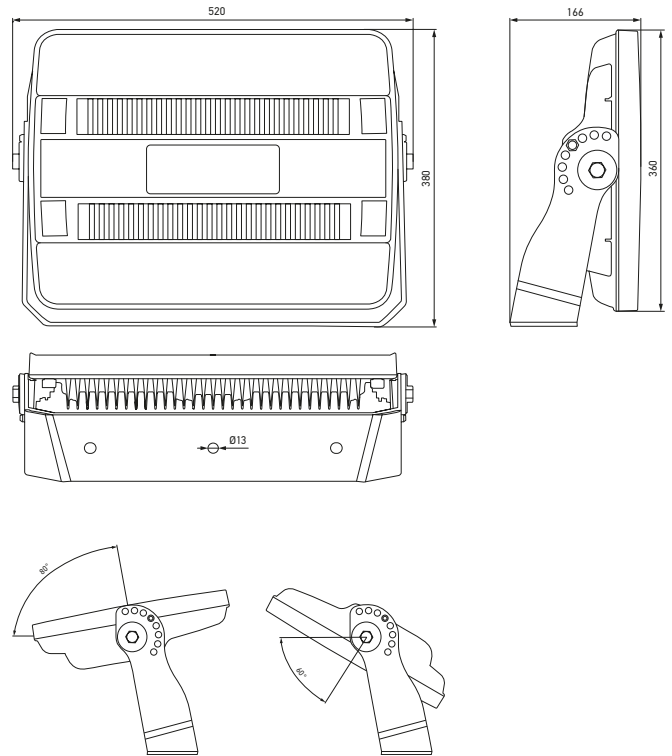

Lamp can be rotated 140°

APPLICATION EXAMPLES AND FURTHER PRODUCT PICTURES



Rear view



Side view

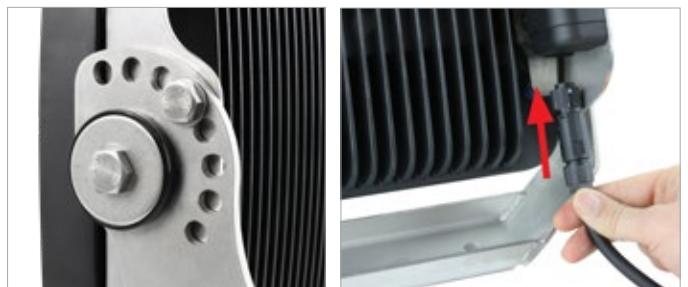



Secure locking mechanism

Supplied with 2.0 m of easy plug-in sheathed cable

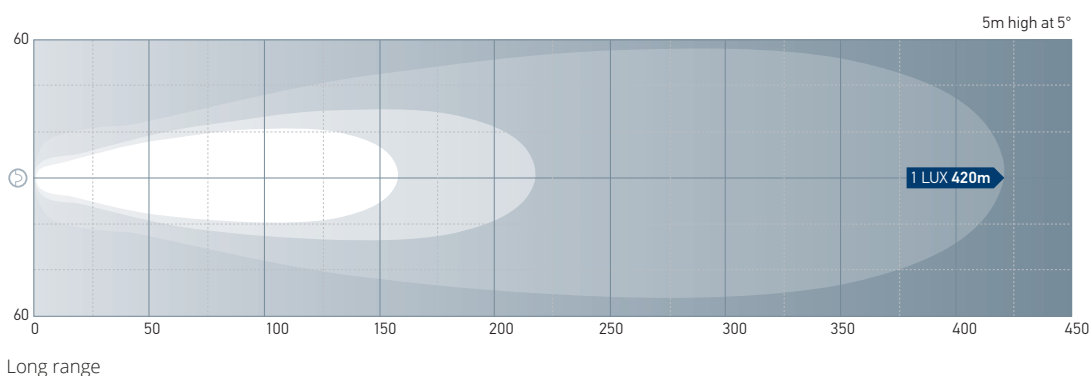
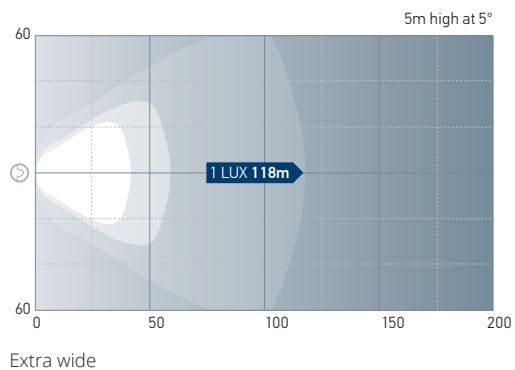
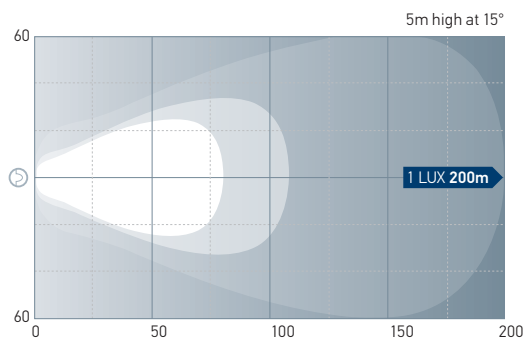
LIGHT DISTRIBUTION



PROGRAM OVERVIEW

Product picture	Description	Part number
	Close range	1GJ 958 334-011
	Long range	1GJ 958 334-021
	Extra wide	1GJ 958 334-031