

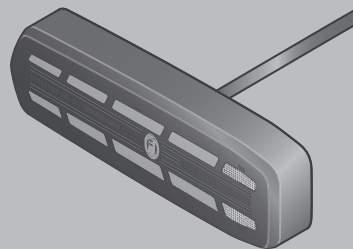

460 890-81 / 12.25



**MONTAGEANLEITUNG**  
LED COMPACT HECKLEUCHTE  
**INSTALLATION INSTRUCTION**  
LED COMPACT COMBINATION REAR LAMP  
**INSTRUCTIONS DE MONTAGE**  
LED COMPACT FEUARRIER  
**MONTERINGSANVISNING**  
LED COMPACT KOMBINERAT BAKLJUS  
**MONTAGEHANDLEIDING**  
LED COMPACT ACHTERLICH COMBINATIE  
**INSTRUCCIONES DE MONTAJE**  
LED COMPACT PILOTO TRASERO COMBINADO  
**ISTRUZIONI DI MONTAGGIO**  
LED COMPACT GRUPPO OTTICO POSTERIORE  
**ASENNUSOHJE**  
LED COMPACT TAKAVALO

**DE PRODUKTHAFTUNG**

- Es sind die nationalen Anbau-, Einbau- und Betriebsvorschriften zu beachten und einzuhalten.
- Lesen Sie bitte vor Gebrauch des Gerätes alle beigelegten Anleitungen und Sicherheits-hinweise.
- Im Zuge von Produktverbesserung behalten wir uns technische und optische Änderungen vor.
- Verwenden Sie nur die Originalersatzteile bzw. nur Ersatzteile die von HELLA freigegeben sind.
- Bei Fragen oder Einbauproblemen, wenden Sie sich bitte an den HELLA Kundendienst, den Großhändler oder an Ihre Werkstatt.
- Weitere Informationen finden Sie auch auf unserer Internetseite ([www.hella.com/techworld](http://www.hella.com/techworld))

**EN PRODUCT LIABILITY**

- National mounting, fitting and operating regulations must be heeded and kept.
- Please read all the instructions and safety notes included before using the device.
- We reserve the right to make technical and optical modifications within the course of product improvement.
- Only use original spare parts or spare parts approved by HELLA.
- If you have any questions or problems with the installation, please contact HELLA Customer Services, a wholesaler or your garage.
- Further information is available on our website ([www.hella.com/techworld](http://www.hella.com/techworld))

**FR RESPONSABILITÉ PRODUIT**

- Les prescriptions nationales en matière de montage et de service doivent être observées et respectées.
- Avant d'utiliser l'appareil lire toutes les instructions de montage et de service fournies ainsi que les conseils de sécurité.
- Dans le cadre de l'amélioration continue de nos produits, nous nous réservons le droit de réaliser des modifications sur les plans technique et optique.
- Utilisez uniquement des pièces d'origine ou des pièces de rechange validées par HELLA.
- Pour toute question ou en cas de problèmes de montage, veuillez contacter le S.A.V. ou le distributeur HELLA ou bien vous adresser à votre garagiste.
- Vous trouverez également des informations complémentaires sur notre site Internet ([www.hella.com/techworld](http://www.hella.com/techworld))

**SV PRODUKTANSVAR**

- De nationella monterings-, installations- och driftföreskrifterna ska beaktas och följas.
- Läs alla medföljande instruktioner och säkerhetsanvisningar innan du använder apparaten.
- Vi förbehåller oss rätten till tekniska och optiska ändringar som förbättrar produkten.
- Använd endast original reservdelar resp. endast reservdelar som har godkänts av HELLA.
- Vid frågor eller monteringsproblem, kontakta HELLA kundtjänst, grossisten eller din verkstad.
- Mer information finns också på vår webbplats ([www.hella.com/techworld](http://www.hella.com/techworld))

**NL PRODUCTAANSPRAKELIJKHEID**

- Men dient de nationale aanbouw-, inbouw- en bedrijfsvoorschriften in acht te nemen en na te leven.
- Lees a.u.b. alvorens het apparaat te gebruiken alle bijgevoegde gebruiksaanwijzingen en veiligheidsinstructies door.
- In het kader van de productverbetering behouden wij ons technische en optische veranderingen voor.
- Gebruik uitsluitend de originele reserveonderdelen, die door Hella vrijgegeven zijn.
- Neem bij vragen of inbouwproblemen contact op met de HELLA klantenservice, de groothandel of het garagebedrijf.
- Meer informatie is ook te vinden op onze website ([www.hella.com/techworld](http://www.hella.com/techworld))

**ES RESPONSABILIDAD CIVIL POR PRODUCTOS DEFECTUOSOS**

- Tienen que observarse y cumplirse con las prescripciones nacionales sobre construcciones anexas, de montaje y de funcionamiento.
- Rogamos que antes de usar el aparato lean todas las instrucciones y advertencias sobre la seguridad adjuntas.
- En aras de la mejora de los productos, nos reservamos el derecho de hacer modificaciones técnicas y ópticas.
- Use sólo recambios originales o bien sólo recambios autorizados por HELLA.
- En caso de dudas o preguntas a la hora del montaje, llame al servicio de atención al cliente de HELLA o dirijase a su Distribuidor o Taller.
- Encontrará más información en nuestra página web ([www.hella.com/techworld](http://www.hella.com/techworld))

IT

#### RESPONSABILITÀ PER IL PRODOTTO

- Si devono rispettare tutte le normative nazionali di attacco, montaggio e funzionamento.
- Prima di usare l'apparecchio, legga per favore tutte le istruzioni e le avvertenze di sicurezza allegate.
- Nell'ambito del perfezionamento del prodotto, ci riserviamo modifiche tecniche ed estetiche.
- Utilizzare solo pezzi di ricambio originali risp. pezzi autorizzati dalla HELLA.
- Per eventuali domande o problemi di installazione contattare l'Assistenza Clienti HELLA, il grossista o rivolgersi alla propria officina.
- Ulteriori informazioni sono disponibili anche sul nostro sito web ([www.hella.com/techworld](http://www.hella.com/techworld))

FI

#### TUOTEVASTUU

- Kansalliset asennus- ja käyttöohjeet on huomioitava ja niitä on noudatettava.
- Lue ennen laitteen käyttöä kaikki oheistetut käyttö- sekä turvaohjeet.
- Jatkuvasta tuotekehittelystä johtuen pidätämme oikeuden teknisiin ja optisiin muutoksiin.
- Käytä vain alkuperäisiä tai HELLA hyväksymiä varaosia.
- Jos sinulla on kysyttävää tai asennusongelmia, käänny HELLA-asiakaspalvelun, tukkuliikkeen tai korjaamon puoleen.
- Lisätietoja löytyy verkkosivustoltamme ([www.hella.com/techworld](http://www.hella.com/techworld)).

**DE** Technische Änderungen vorbehalten

**EN** Subject to alteration without notice

**FR** Sous réserve de modifications techniques









**SV** Vi reserverar oss för tekniska ändringar



**NL** Technische wijzigingen voorbehouden





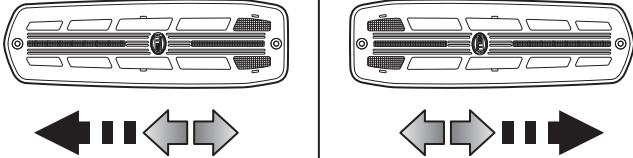

**ES** Reservadas modificaciones técnicas

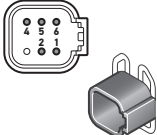
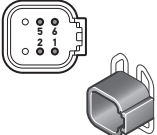
**IT** Con riserva di modifiche tecniche

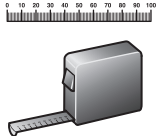
**FI** Oikeus teknisiin muutoksiin pidätetään

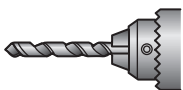
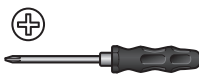
Zeichenerklärung Explanation symbols Explication des symboles	Symbolförklaring Legenda Aclaración de símbolos	Legenda Piirroksen selitys
		
		
<p>(DE) Richtig (EN) Correct (FR) Correct (SV) Rätt (NL) Goed (ES) Correcto (IT) Giusto (FI) Oikein</p>	<p>(DE) Falsch (EN) Incorrect (FR) Incorrect (SV) Fel (NL) Fout (ES) Erróneo (IT) Sbagliato (FI) Väärin</p>	<p>(DE) Positionspfeil (EN) Location/Position Arrow (FR) Flèche de Position (SV) Positionpil (NL) Lokatie/Positie pijl (ES) Flecha de posición (IT) Freccia di posizione (FI) Paikannusnuoli</p>
		<p>(DE) Bewegungspfeil (EN) Movement Arrow (FR) Flèche indiquant sens du mouvement (SV) Rörelsepil (NL) Richtingspijl (ES) Flecha de movimiento (IT) Freccia di movimento (FI) Liikesuuntanuoli</p>
		
		
<p>(DE) Achtung (EN) Warning (FR) Attention (SV) Varning (NL) Let op (ES) Atención (IT) Attenzione (FI) Huomio</p>	<p>(DE) Abklemmen (EN) Disconnect (FR) Déconnecter (SV) Koppla los (NL) Demonteren (ES) Desconectar (IT) Staccare (FI) Irrota</p>	<p>(DE) Verbinden (EN) Connect (FR) Connecter (SV) Ansult (NL) In elkaar (ES) Conectar (IT) Collegare (FI) Yhdistä</p>
		<p>(DE) Siehe (EN) Look/See (FR) Voir (SV) Se (NL) Kijkken naar (ES) Ver (IT) Vedere (FI) Katso</p>

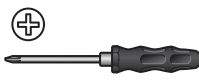
Lieferumfang Scope of delivery Fourniture	Leveransomfattning Leveringsomvang Alcance de suministro	Contenuto della confezione Toimituksen sisältö	
			
 <p data-bbox="389 1236 507 1447"> <b>327 300-01</b>  <b>327 300-02</b>  <b>327 300-05</b>  <b>327 300-06</b>  <b>327 300-17</b>  <b>327 300-18</b>  <b>327 300-21</b>  <b>327 300-22</b> </p>	 <p data-bbox="622 1236 740 1447"> <b>327 300-09</b>  <b>327 300-10</b>  <b>327 300-13</b>  <b>327 300-14</b>  <b>327 300-25</b>  <b>327 300-26</b>  <b>327 300-29</b>  <b>327 300-30</b> </p>	 <p data-bbox="865 1236 983 1447"> <b>327 300-03</b>  <b>327 300-04</b>  <b>327 300-07</b>  <b>327 300-08</b>  <b>327 300-19</b>  <b>327 300-20</b>  <b>327 300-23</b>  <b>327 300-24</b> </p>	 <p data-bbox="1104 1236 1222 1447"> <b>327 300-11</b>  <b>327 300-12</b>  <b>327 300-15</b>  <b>327 300-16</b>  <b>327 300-27</b>  <b>327 300-28</b>  <b>327 300-31</b>  <b>327 300-32</b> </p>

<b>Benötigte Montagewerkzeuge</b> <b>Installation tools required</b> <b>Outillage de montage requis</b>	<b>Nödvändiga monteringsverktyg</b> <b>Benodigde montagewerktuigen</b> <b>Herramientas de montaje necesarias</b>	<b>Attrezzi necessari per il montaggio</b> <b>Tarvittavat asennustyökalut</b>
		
		
		



**Vor Steinschlag geschützt montieren!**

**Mount protected against stone chipping!**

**Monter à l'abri des chutes de pierres!**

**Montera skyddat från stenskott!**

**Tegen steenslag beschermd monteren!**



**¡Montar de manera que quede protegido**

**ante la acción de la gravilla!**

**Montare in modo che sia protetto dall'urto di pietre!**

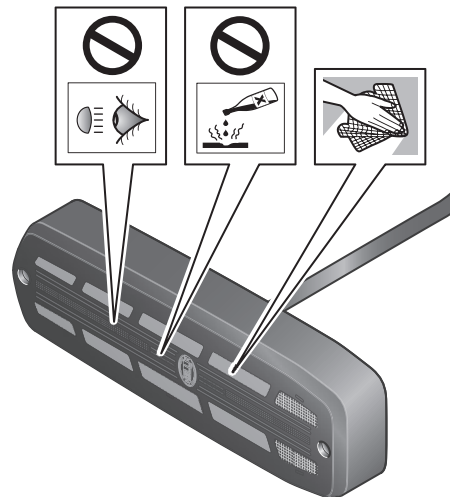
**Asenna suojaan kiveniskuilta!**

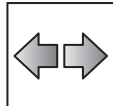

Zeichenerklärung Explanation symbols Explication des symboles	Symbolförklaring Legenda Aclaración de símbolos	Legenda Piirroksen selitys	
			
<p><b>(DE)</b> Schlusslicht <b>(EN)</b> Tail light <b>(FR)</b> Feu arriere <b>(SV)</b> Bakljus <b>(NL)</b> Achterlicht <b>(ES)</b> Luz trasera <b>(IT)</b> Luce di coda <b>(FI)</b> Takavallo</p>	<p><b>(DE)</b> Bremslicht <b>(EN)</b> Stop light <b>(FR)</b> Feu stop <b>(SV)</b> Bromsljus <b>(NL)</b> Remlicht <b>(ES)</b> Luz de paro <b>(IT)</b> Luce stop <b>(FI)</b> Jarruvalo</p>	<p><b>(DE)</b> Rückfahrlicht <b>(EN)</b> Reverse <b>(FR)</b> Freu de recul <b>(SV)</b> Omv.nd <b>(NL)</b> Reverse <b>(ES)</b> Inversa <b>(IT)</b> Inversione <b>(FI)</b> Peruutusvalo</p>	<p><b>(DE)</b> Blinklicht <b>(EN)</b> Turn indicator <b>(FR)</b> Feu clignotant <b>(SV)</b> Blinkerljus <b>(NL)</b> Richtingaanwijzerlicht <b>(ES)</b> Luz del indicadoe de direccion <b>(IT)</b> Direzioneeluze indicatore <b>(FI)</b> Vilkku</p>

**DE** Heckleuchten dürfen bei Nachrüstung nur paarig getauscht werden.  
Es sind die nationalen Anbau-, Einbau- und Betriebsvorschriften zu beachten und einzuhalten.

**EN** For retrofitting, rear combination lamps may only be replaced in pairs.  
National mounting, fitting and operating regulations must be heeded and kept.

**FR** En seconde monte, les feux arrière doivent être obligatoirement remplacés par paire.  
Les prescriptions nationales en matière de montage et de service doivent être observées et respectées.

**SV** Baklyktorna får endast bytas parvis vid eermontering.  
De nationella monterings-, installations- och driftföreskrifterna ska beaktas och följas.

**NL** Achterlichten mogen bij een ombouw alleen per twee worden vervangen.  
Men dient de nationale aanbouw-, inbouw- en bedrijfsvoorschriften in acht te nemen en na te leven.

**ES** Los pilotos traseros deben sustituirse siempre por parejas.  
Tienen que observarse y cumplirse con las prescripciones nacionales sobre construcciones anexas, de montaje y de funcionamiento.

**IT** In caso di retrofitting i fanali posteriori possono essere sostituiti solo due a due.  
Si devono rispettare tutte le normative nazionali di attacco, montaggio e funzionamento.

**FI** Takavalaja saa vaihtaa jälkiasennuksessa ainoastaan pareittain.  
Kansalliset asennus- ja käyttöohjeet on huomioitava ja niitä on noudatettava.

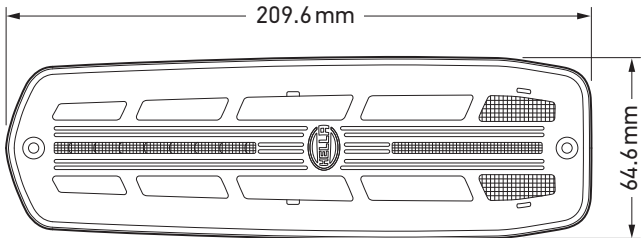
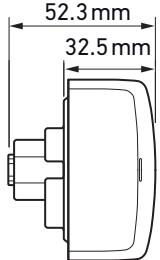
Montage Mounting Montage Général	Montering Montage Montaje	Montaggio Asennus
<div style="display: flex; justify-content: space-around; align-items: center;"> <div style="text-align: center;">  <p>209.6 mm</p> <p>64.6 mm</p> </div> <div style="text-align: center;">  <p>52.3 mm</p> <p>32.5 mm</p> </div> </div>		

12

- (DE)** Heckleuchten dürfen bei Nachrüstung nur paarig getauscht werden.
- (EN)** For retrofitting, rear combination lamps may only be replaced in pairs.
- (FR)** En seconde monte, les feux arrière doivent être obligatoirement remplacés par paire.
- (SV)** Baklyktorna får endast bytas parvis vid eftermontering.
- (NL)** Achterlichten mogen bij een ombouw alleen per twee worden vervangen.
- (ES)** Los pilotos traseros deben sustituirse siempre por parejas.
- (IT)** In caso di retrofitting i fanali posteriori possono essere sostituiti solo due a due.
- (FI)** Takavalvoja saa vaihtaa jälkiasennuksessa ainoastaan pareittain.

**ECE R3**      **ECE R7**      **ECE R48**  
**ECE R4**      **ECE R23**      **ECE R91**  
**ECE R6**      **ECE R38**

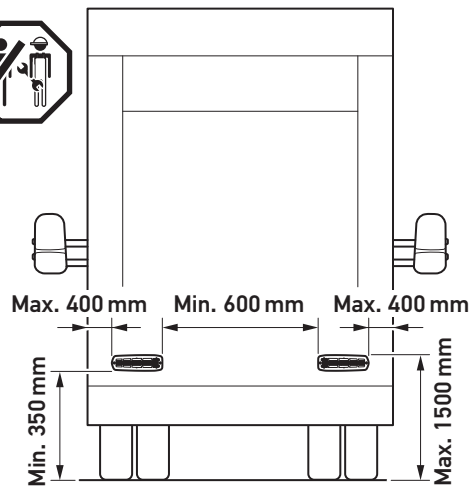



- 327 300-01
- 327 300-05
- 327 300-09
- 327 300-13
- 327 300-17
- 327 300-21
- 327 300-25
- 327 300-29



- 327 300-02
- 327 300-06
- 327 300-10
- 327 300-14
- 327 300-18
- 327 300-22
- 327 300-26
- 327 300-30

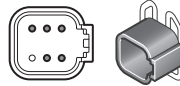



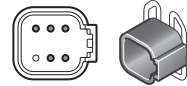



- 327 300-04
- 327 300-08
- 327 300-12
- 327 300-16
- 327 300-20
- 327 300-24
- 327 300-28
- 327 300-32



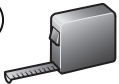





- 327 300-03
- 327 300-07
- 327 300-11
- 327 300-15
- 327 300-19
- 327 300-23
- 327 300-27
- 327 300-31

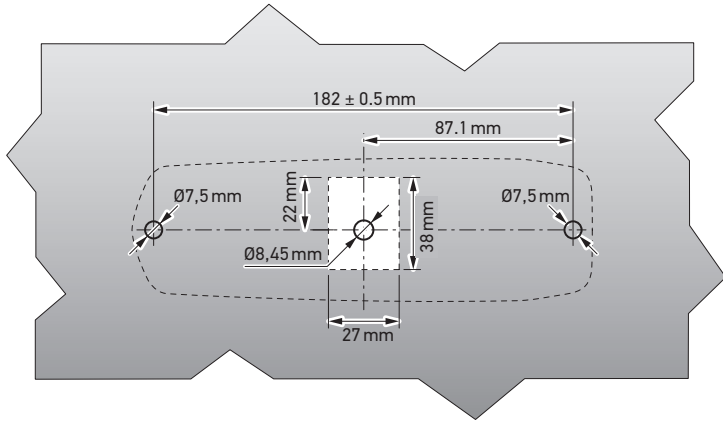
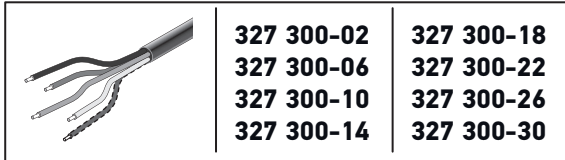

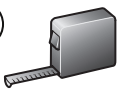



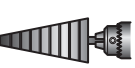

- 1 
- 2 
- 3 
- 4 
- 5 
- 6 

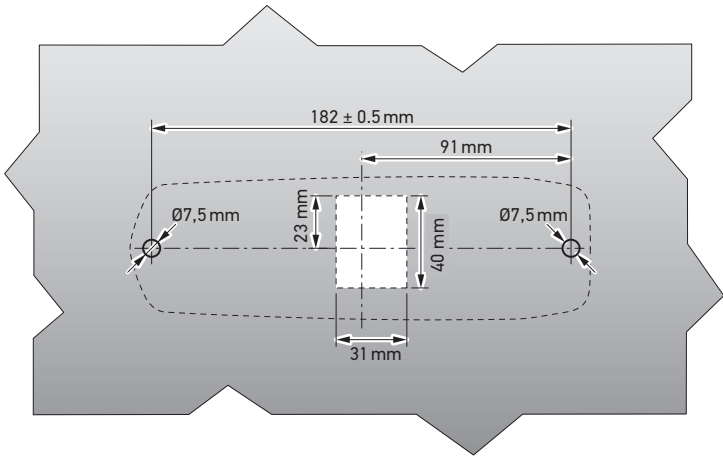

- 1 
- 2 
- 3 
- 4 
- 5 
- 6 

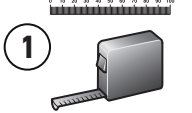
	<b>327 300-04</b>	<b>327 300-20</b>
	<b>327 300-08</b>	<b>327 300-24</b>
	<b>327 300-12</b>	<b>327 300-28</b>
	<b>327 300-16</b>	<b>327 300-32</b>

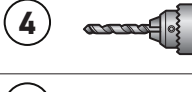
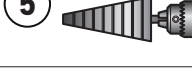

- 1 
- 2 
- 3 
- 4 
- 5 
- 6 

		<b>327 300-03</b>	<b>327 300-19</b>
		<b>327 300-07</b>	<b>327 300-23</b>
		<b>327 300-11</b>	<b>327 300-27</b>
		<b>327 300-15</b>	<b>327 300-31</b>

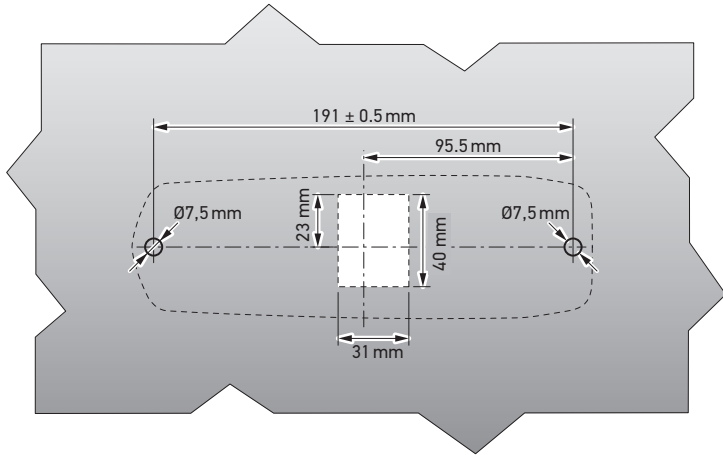

19

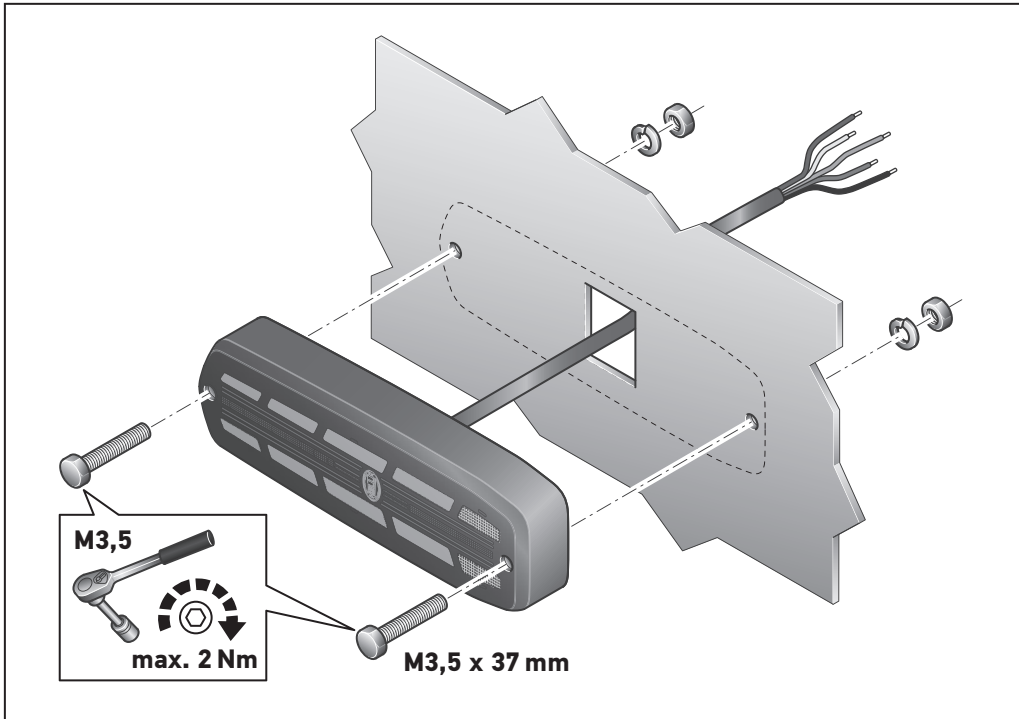





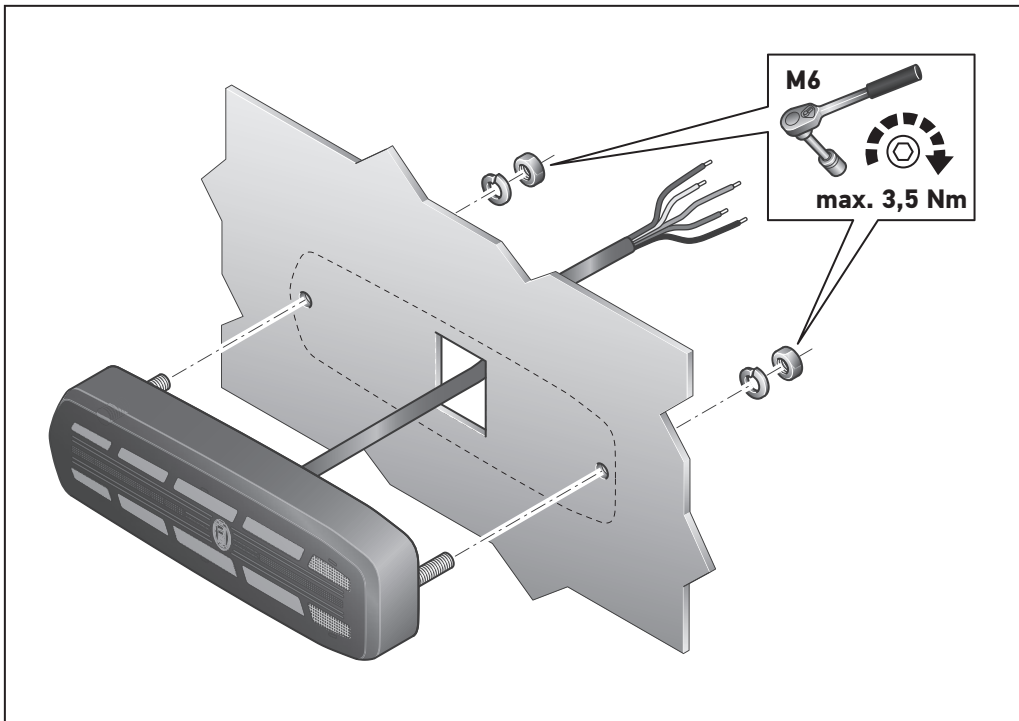





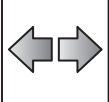

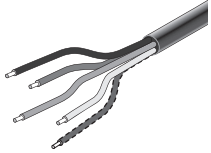

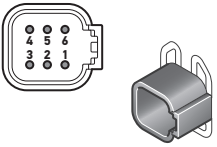
20







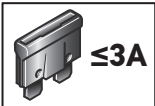

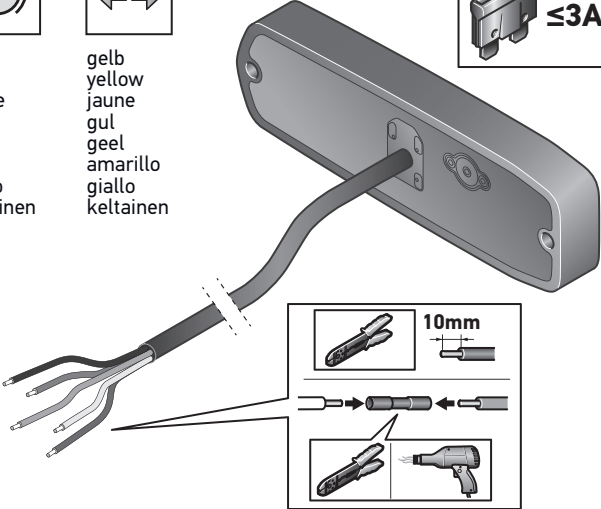

Elektrischer Anschluss Electrical connection Branchement électrique	Elektrisk anslutning Elektrische aansluiting Conexión eléctrica	Collegamento elettrico Osaluettelo
 weiß white blanc vit wit blanco bianco valkoinen	 rot red rouge röd rood rojo rosso punainen	   gelb yellow jaune gul geel amarillo giallo keltainen  schwarz black noir svart zwart negro nero musta  grün green vert grön groen verde verde vihreä
  <b>22 - 23</b>	  <b>24 - 25</b>	



Elektrischer Anschluss Electrical connection Branchement électrique	Elektrisk anslutning Elektrische aansluiting Conexión eléctrica	Collegamento elettrico Osaluettelo
<b>327 300-01</b> <b>327 300-02</b> <b>327 300-05</b> <b>327 300-06</b> <b>327 300-17</b> <b>327 300-18</b> <b>327 300-21</b> <b>327 300-22</b>	  	 ≤3A
weiß white blanc vit wit blanco bianco valkoinen	red rot rouge röd rood rojo rosso punainen	gelb yellow jaune gul geel amarillo giallo keltainen
 schwarz black noir svart zwart negro nero musta	 grün green vert grön groen verde verde vihreä	



Elektrischer Anschluss Electrical connection Branchement électrique	Elektrisk anslutning Elektrische aansluiting Conexión eléctrica	Collegamento elettrico Osaluettelo
		
		
weiß white blanc vit wit blanco bianco valkoinen	red rot rouge röd rood rojo rosso punainen	gelb yellow jaune gul geel amarillo giallo keltainen
		schwarz black noir svart zwart negro nero musta
<b>327 300-09</b>		
<b>327 300-10</b>		
<b>327 300-13</b>		
<b>327 300-14</b>		
<b>327 300-25</b>		
<b>327 300-26</b>		
<b>327 300-29</b>		
<b>327 300-30</b>		

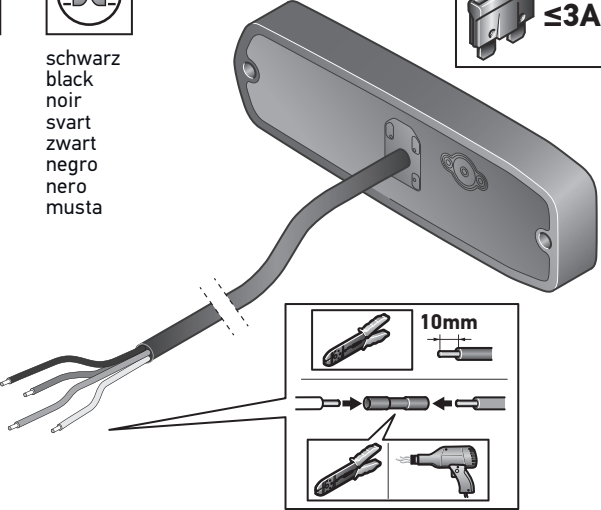

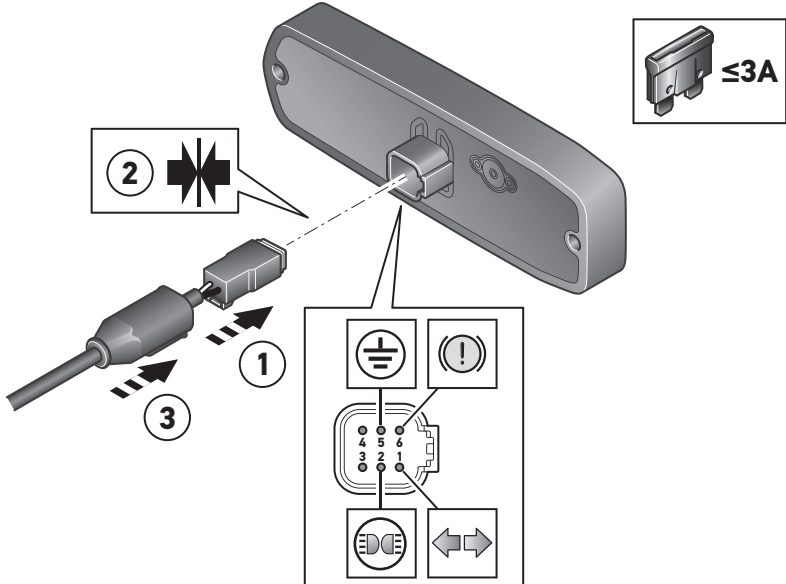

Elektrischer Anschluss Electrical connection Branchement électrique	Elektrisk anslutning Elektrische aansluiting Conexión eléctrica	Collegamento elettrico Osaluettelo
<p>327 300-03 327 300-04 327 300-07 327 300-08 327 300-19 327 300-20 327 300-23 327 300-24</p>		

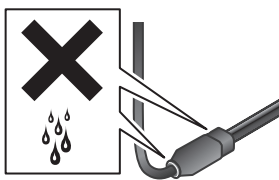
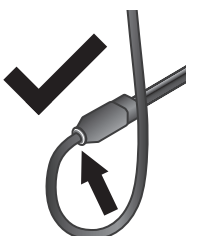
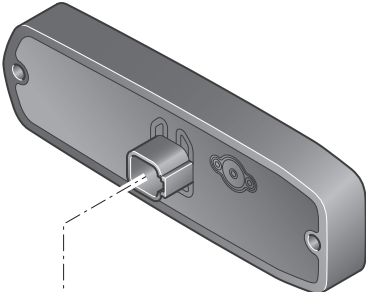
Elektrischer Anschluss Electrical connection Branchement électrique	Elektrisk anslutning Elektrische aansluiting Conexión eléctrica	Collegamento elettrico Osaluettelo
<p>327 300-11 327 300-12 327 300-15 327 300-16 327 300-27 327 300-28 327 300-31 327 300-32</p>		

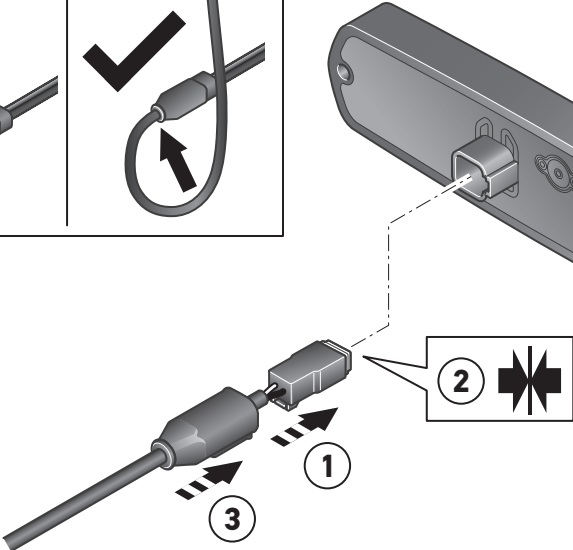
Elektrischer Anschluss Electrical connection Branchement électrique	Elektrisk anslutning Elektrische aansluiting Conexión eléctrica	Collegamento elettrico Osaluettelo
		
		

**Technische Daten**  
**Technical Data**  
**Caractéristiques techniques**

**Tekniska data**  
**Technische gegevens**  
**Datos técnicos**

**Dati tecnici**  
**Tekniset tiedot**



	Nennspannung	Spannungsbereich	Farbe	LEDs	Eingangswerte MIN (mA) / MAX (mA)	Zulässige Umgebungstemperatur	Schutzklasse
<b>DE</b>	Nominal voltage	Range of voltage	Colour	LEDs	Input values MIN (mA) / MAX (mA)	Admissible ambient temperature	Class of protection
<b>EN</b>	Nominal voltage	Range of voltage	Colour	LEDs	Input values MIN (mA) / MAX (mA)	Admissible ambient temperature	Class of protection
<b>FR</b>	Tension nominale	Valeurs d'entrée	Couleur	LEDs	Valeurs d'entrée MIN (mA) / MAX (mA)	Température ambiante admissible	Classe de protection
<b>SV</b>	Märkspänning	Spänningsområde	Färg	LEDs	Ingångsvärden MIN (mA) / MAX (mA)	Tillåten omgivningstemperatur	Skyddsklass
<b>NL</b>	Nominale spanning	Spanningsbereik	Kleur	LEDs	Ingangswaarden MIN (mA) / MAX (mA)	Toegestane omgeings-temperatuur	Beschermklasse
<b>ES</b>	Tensión nominal	Margen de tensión	Color	LEDs	Valores de entrada MIN (mA) / MAX (mA)	Temperatura ambiente admisible	Clase de protección
<b>IT</b>	Tensione nominale	Intervallo di tensione	Colore	LEDs	Valori di ingresso MIN (mA) / MAX (mA)	Temperatura ambiente ammissibile	Categoria di protezione
<b>FI</b>	Nimellisjännite	Jännitealue	Väri	LEDs	Tuloarvot MIN (mA) / MAX (mA)	Sallittu ympäristölämpötila	Kotelointiluokka
	12 V 24 V	9 V - 16 V 18 V - 32 V	rot red rouge röd rojo rosso punainen	6	13,5 V 96,3 - 148,5	28 V 101,7 - 150,7	-40° C → +60° C IP6K9K

Technische Daten Technical Data Caractéristiques techniques	Tekniska data Technische gegevens Datos técnicos	Dati tecnici Tekniset tiedot
---	--	---------------------------------



ISO 13207



	Nennspannung	Spannungsbereich	Farbe	LEDs	Eingangswerte MIN (mA) / MAX (mA)	Zulässige Umgebungstemperatur	Schutzklasse	
<b>DE</b>	Nominal voltage	Range of voltage	Colour	LEDs	Input values MIN (mA) / MAX (mA)	Admissible ambient temperature	Class of protection	
<b>EN</b>	Tension nominale	Valeurs d'entrée	Couleur	LEDs	Valeurs d'entrée MIN (mA) / MAX (mA)	Température ambiante admissible	Classe de protection	
<b>FR</b>	Märkspänning	Spänningsområde	Färg	LEDs	Ingångsvärden MIN (mA) / MAX (mA)	Tillåten omgivings-temperatur	Skyddsklass	
<b>SV</b>	Nominale spanning	Spanningsbereich	Kleur	LEDs	Ingangswaarden MIN (mA) / MAX (mA)	Toegestane omgeings-temperatuur	Beschermklasse	
<b>NL</b>	Tensión nominal	Margen de tensión	Color	LEDs	Valores de entrada MIN (mA) / MAX (mA)	Temperatura ambiente admisible	Clase de protección	
<b>ES</b>	Tensione nominale	Intervallo di tensione	Colore	LEDs	Valori di ingresso MIN (mA) / MAX (mA)	Temperatura ambiente ammessa	Categoria di protezione	
<b>IT</b>	Nimellisijännite	Jännitealue	Väri	LEDs	Tuloarvot MIN (mA) / MAX (mA)	Sallittu ympäristölämpötila	Kotelointiluokka	
<b>FI</b>								
	12 V 24 V	9 V - 16 V 18 V - 32 V	gelb yellow jaune gul geel amarillo giallo keltainen	8	13,5 V 123,3 - 202,4	28 V 76,5 - 116,6	-40° C → +60° C	IP6K9K

<b>Technische Daten</b> <b>Technical Data</b> <b>Caractéristiques techniques</b>	<b>Tekniska data</b> <b>Technische gegevens</b> <b>Datos técnicos</b>	<b>Dati tecnici</b> <b>Tekniset tiedot</b>
--	---	---



	Nennspannung	Spannungsbereich	Farbe	LEDs	Eingangswerte MIN (mA) / MAX (mA)	Zulässige Umgebungstemperatur	Schutzklasse
<b>DE</b>	Nominal voltage	Range of voltage	Colour	LEDs	Input values MIN (mA) / MAX (mA)	Admissible ambient temperature	Class of protection
<b>EN</b>	Tension nominale	Valeurs d'entrée	Couleur	LEDs	Valeurs d'entrée MIN (mA) / MAX (mA)	Température ambiante admissible	Classe de protection
<b>FR</b>	Märkspänning	Spänningsområde	Färg	LEDs	Ingångsvärden MIN (mA) / MAX (mA)	Tillåten omgivings-temperatur	Skyddsklass
<b>SV</b>	Nominale spanning	Spänningsbereich	Kleur	LEDs	Ingangswaarden MIN (mA) / MAX (mA)	Toegestane omgeings-temperatuur	Beschermklasse
<b>NL</b>	Tensión nominal	Margen de tensión	Color	LEDs	Valores de entrada MIN (mA) / MAX (mA)	Temperatura ambiente admisible	Clase de protección
<b>ES</b>	Tensione nominale	Intervallo di tensione	Colore	LEDs	Valori di ingresso MIN (mA) / MAX (mA)	Temperatura ambiente ammessa	Categoria di protezione
<b>IT</b>	Nimellisijännite	Jännitealue	Väri	LEDs	Tuloarvot MIN (mA) / MAX (mA)	Sallittu ympäristölämpötila	Kotelointiluokka
<b>FI</b>							

29



12 V	24 V	9 V - 16 V	18 V - 32 V	rot red rouge röd rood rojo rosso punainen	26	13,5 V 118,8 - 237,6	28 V 73,8 - 147,4	-40° C → +60° C	IP6K9K
------	------	------------------	-------------------	---	----	-------------------------	----------------------	-----------------	--------

<b>Technische Daten</b> <b>Technical Data</b> <b>Caractéristiques techniques</b>	<b>Tekniska data</b> <b>Technische gegevens</b> <b>Datos técnicos</b>	<b>Dati tecnici</b> <b>Tekniset tiedot</b>
--	---	---



	Nennspannung	Spannungsbereich	Farbe	LEDs	Eingangswerte MIN (mA) / MAX (mA)		Zulässige Umgebungstemperatur		Schutzklasse			
	Nominal voltage	Range of voltage	Colour	LEDs	Input values MIN (mA) / MAX (mA)		Admissible ambient temperature		Class of protection			
	Tension nominale	Valeurs d'entrée	Couleur	LEDs	Valeurs d'entrée MIN (mA) / MAX (mA)		Température ambiante admissible		Classe de protection			
	Märkspänning	Spänningsområde	Färg	LEDs	Ingångsvärden MIN (mA) / MAX (mA)		Tillåten omgivings-temperatur		Skyddsklass			
	Nominale spanning	Spanningsbereik	Kleur	LEDs	Ingangswaarden MIN (mA) / MAX (mA)		Toegestane omgeings-temperatuur		Beschermklass			
	Tensión nominal	Margen de tensión	Color	LEDs	Valores de entrada MIN (mA) / MAX (mA)		Temperatura ambiente admisible		Clase de protección			
	Tensione nominale	Intervallo di tensione	Colore	LEDs	Valori di ingresso MIN (mA) / MAX (mA)		Temperatura ambiente ammessa		Categoria di protezione			
Nimellisjännite	Jännitealue	Väri	LEDs	Tuloarvot MIN (mA) / MAX (mA)		Sallittu ympäristölämpötila		Kotelointiluokka				
12 V	24 V	9 V - 16 V	18 V - 32 V	weiß white blanc vit wit blanco bianco valkoinen	2	13,5 V 90,9 - 138,6	28 V 54,9 81,4	-40° C → +60° C		IP6K9K		



**31**

Typprüfung  
Type approval  
Essai de type  
Typgodkännande  
Typegoedkeuring  
Aprobación de tipo  
Approvazione del tipo  
Tyypihyväksyntä

UN - R10 (ECE)





ISO 13207



32

DE

**Hinweis!** Eine Blinkleuchten Ausfallkontrolle ist nach ECE- R48 gesetzlich vorgeschrieben. Vor dem Einbau muss eine Integrationsmöglichkeit an die fahrzeugseitige Blinkleuchten-Ausfallkontroll-Funktion überprüft und gewährleistet werden. Ist die Blinkleuchten-Ausfallkontrolle nicht gewährleistet, erlischt die allgemeine Betriebslaubnis des Fahrzeugs. Bitte beachten Sie in diesem Zusammenhang die jeweiligen länderspezifischen gesetzlichen Bestimmungen.

EN

**Note!** A flashing signal failure check is required by law according to ECE-R48. Prior to installation, an integration option to the on-board turn signal failure check function must be checked and ensured. If the indicator failure check is not guaranteed, the general vehicle type approval will expire. Please observe the respective country-specific legal regulations in this context.

FR

**Remarque importante !** Un contrôle de panne des feux clignotants est obligatoire selon ECE- R48. Avant de procéder au montage, il convient de vérifier et d'assurer que le dispositif à installer puisse être intégré à la fonction du contrôle de panne des feux clignotants du véhicule. Si le contrôle de panne des feux clignotants n'est pas garanti, l'autorisation d'exploitation générale du véhicule s'éteint. Veuillez observer à cet effet les dispositions légales en vigueur dans votre pays.

SV

**Observera!** Bortfallskontroll av blinklampor är lagstadgad enligt ECE- R48. Före monteringen måste en integrationsmöjlighet kontrolleras och säkerställas för bortfallskontrollfunktionen hos fordonets blinklampor. Om bortfallskontrollen av blinklamporna inte kan säkerställas upphör fordonets allmänna driftstillstånd att gälla. Följ i detta sammanhang de specifika lagbestämmelserna i respektive land.



ISO 13207



33

**NL**

**Aanwijzing!** Een knipperlicht-uitvalcontrole is volgens ECE- R48 wettelijk voorgeschreven. Voor de inbouw moet een integratiemogelijkheid aan de knipperlicht-uitvalcontrole aan voertuigzijde worden gecontroleerd en gegarandeerd. Indien de knipperlichten-uitvalcontrole niet aanwezig is, vervalt de algemene ABE (algemene gebruiksvergunning) van het voertuig. Let in dit verband op de desbetreffende landspecifieke wettelijke voorschriften.

**ES**

**¡Nota!** El control de fallos de los pilotos intermitentes, según el Reglamento CEE 48, es obligatorio por ley. Antes de su instalación deberá comprobarse que es posible instalar en el vehículo el control de fallos los pilotos intermitentes, de manera que su correcto funcionamiento quede garantizado. Si no se pudiera garantizar el control de fallos de los pilotos intermitentes, el vehículo perdería el permiso de circulación. Respete siempre las correspondientes disposiciones legales relacionadas con este asunto.

**IT**

**Nota!** La norma ECE R48 prevede l'obbligo di dotarsi di un sistema di controllo dei guasti degli indicatori di direzione. Prima di installare il sistema occorre verificare che esso sia integrabile nella funzione di controllo dei guasti degli indicatori di direzione del veicolo. Se non si garantisce la disponibilità di un sistema di controllo dei guasti degli indicatori di direzione, decade il permesso di circolazione generale del veicolo. A questo riguardo si raccomanda di osservare le disposizioni di legge previste da ciascun Paese.

**FI**

**Tärkeää!** Vilkkuvalojen toiminnanvalvonta on pakollinen ECE-säännön 48 mukaan. Ennen asennusta täytyy tarkistaa, että se on mahdollista liittää ajoneuvon vilkkuvalojen toiminnanvalvontatoimintoon. Jos vilkkuvalojen toiminnanvalvontaa ei ole taattu, ajoneuvo ei ole enää hyväksytty tieliikennekäyttöön. Noudata tässä yhteydessä aina maakohtaisia lakimääräyksiä.

**DE** Beleuchtungsanlage auf einwandfreie Funktion hin prüfen  
Die einzelnen Funktionen der Leuchte dürfen nur mit einer fahrzeugseitigen Sicherung von max. 3A betrieben werden  
Der Betrieb der Leuchte mit Wechselspannung oder getakteter Gleichspannung ist nicht zulässig!  
Die Sicherung ist entsprechend der Leistung des Verbrauchers und dem dazu benötigten Kabelquerschnitt zu berechnen.

**EN** Check that the lighting system is working perfectly  
The single functions of the lamp are allowed to operate with a vehicle side fuse protection of max. 3A.  
Operation of the light using alternating voltage or clocked direct voltage is not permitted!  
The fuse must be calculated according to the power of the consumer and the required cable cross-section.

**FR** Contrôler le bon fonctionnement de l'installation d'éclairage  
Les différentes fonctions du feu ne peuvent être utilisées qu'avec un fusible embarqué de 3A maximum.  
Le fonctionnement du feu avec une tension alternative ou une tension continue cadencée n'est pas admis!  
Le fusible doit être calculé en fonction de la puissance du consommateur et de la section de câble requise.

**SV** Kontrollera att ljussystemet fungerar felfritt  
Lampans enskilda funktioner får endast användas med en fordonsmonterad säkring på max. 3A.  
Lampans får inte användas med växelspanning eller taktad likspänning!  
Säkringen måste beräknas utifrån konsumentens effekt och det nödvändiga kabeltvärsnittet.

**NL** Controleer of de verlichting goed functioneert  
De afzonderlijke functies van de verlichting mogen alleen worden bediend met een zekering aan de voertuigzijde van max. 3 A.  
Het gebruik van de lamp met wisselspanning of getacte gelijkspanning is niet toegestaan!  
De zekering moet worden berekend op basis van het vermogen van de verbruiker en de vereiste kabeldoorsnede.

**ES** Comprobar que el sistema de iluminación funciona impecablemente  
Las funciones individuales de la luz sólo pueden funcionar con un fusible del lado del vehículo de máx. 3A.  
¡No es admisible el funcionamiento de las luces con corriente alterna o corriente continua sincronizada!  
El fusible debe calcularse en función de la potencia del consumidor y de la sección del cable requerida.

**IT** Controllare la perfetta funzionalità dell'impianto di illuminazione  
Le singole funzioni della luce possono essere azionate solo con un fusibile lato veicolo di max. 3A.  
Non è consentito attivare i fanali con tensione alternata o tensione continua ciclica!  
Il fusibile deve essere calcolato in base alla potenza dell'utenza e alla sezione del cavo richiesta.

**FI** Tarkasta valaistusjärjestelmän toiminta  
Valon yksittäisiä toimintoja saa käyttää vain ajoneuvon puoleisella enintään 3 A:n sulakkeella.  
Valoa ei saa käyttää vaihtojännitteellä eikä tahdistetulla tasajännitteellä!  
Sulake on laskettava kuluttajan tehon ja tarvittavan kaapelin poikkileikkauksen mukaan.

- DE** Entsorgen Sie die Verpackung und das Produkt entsprechend der nationalen und regionalen geltenden Bestimmungen und Gesetze.
- EN** Please dispose of the packaging and the product in accordance with the national and regional recycling regulations and laws.
- FR** Éliminer l'emballage et le produit conformément aux réglementations et lois nationales et régionales en vigueur.
- SV** Kassera förpackningen och produktkabeln i enlighet med nationella och regionala återvinningsbestämmelser och lagar.
- NL** Dank de verpakking en het product af in overeenstemming met de geldende nationale en regionale voorschriften en wetgeving.
- ES** Elimine el embalaje y el producto según las disposiciones y leyes vigentes en su país y región.
- IT** Smaltire la confezione e il prodotto secondo le disposizioni e le leggi nazionali e regionali vigenti.
- FI** Hävitä pakkaus ja tuotteen kaapeli kansallisten ja alueellisten kierrätysmääräysten ja -lakien mukaisesti.



**HELLA GmbH & Co. KGaA**  
Rixbecker Straße 75  
59552 Lippstadt / Germany

[www.hella.com](http://www.hella.com)

© HELLA GmbH & Co. KGaA, Lippstadt  
460 890-81 / 12.25