



BRIEF INFORMATION

K-LED QUADRA 100

- The QUADRA design combines clear geometric contours with rounded edges, creating a cohesive, aerodynamic shape.
- The design is available in five colors as well as two two-tone variants, offering a wide range of customization options.
- Robust build quality and flexible mounting options make this beacon easy to use for a wide range of applications

PRODUCT FEATURES

The FORVIA HELLA K-LED QUADRA 100 combines modern design with functionality and easy installation.

Designed to meet the demands of today's commercial vehicles, emergency fleets, construction machinery, agricultural and mining equipment, the beacon blends bold design with robust performance.

The K-LED QUADRA 100 features high-quality. A vibration resistance of 9.6 g is achieved through a sturdy aluminum base for effective heat dissipation combined with a robust polycarbonate lens. Various mounting options provide a high level of flexibility.

**K-LED QUADRA 100
Beacon**

Base plate

Rubber pad

**112 - 117 mm
Pitch Circle Diameter
(Universal)**



**178 mm
Pitch Circle Diameter
(Universal)**

**128 - 132 mm
Pitch Circle Diameter
(EU)**

**148 - 152 mm
Pitch Circle Diameter
(USA & NAFTA)**

TECHNICAL DETAILS





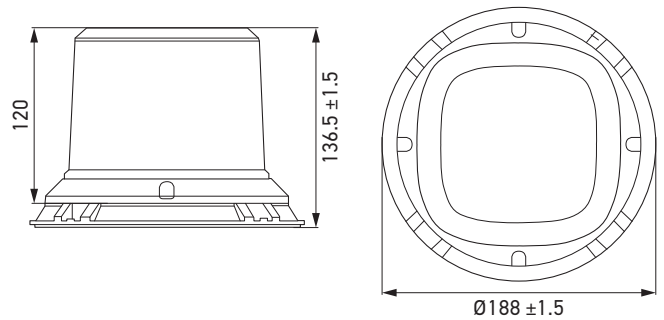

Technical data	
Operating voltage range	Multi-voltage (10 – 30 V)
Rated voltage	12 V / 24 V
Light function	Double flashing, rotating & steady ON*
Flash rate	125 FPM
Material	Base: Aluminium Mounting Plate: Polycarbonate Lens: Polycarbonate
Weight	Single color: 1,294 g Dual color: 1,298 g
Temperature range	-40 to +60 °C
Protection class	IP 67, IP 69K
Approved	ECE-R10, ECE-R65**, ADR / GGVSEB
Compliant	CISPR 25 Class 5, UKCA, RCM, SAE J845 Class 1***
Protection	Polarity reversal protection, overvoltage protection
Mounting	Fixed surface mounting
Connection	300 mm cable, with open ends

* Steady ON not available in dual colour options
 ** Not available for green & white colour options
 *** Green variant is SAE J845 Class 3

Dimensional sketch



PROGRAM OVERVIEW

Product picture	Light colour	Power consumption	Light source	Function	Part number	PU*
	Amber	48 W	48 LEDs	Double Flash, Rotating and Steady ON	2XD 357 558-001	1
	Blue	96 W	32 LEDs		2XD 357 558-101	1
	Red				2XD 357 558-201	1
	Green	48 W	48 LEDs		2XD 357 558-301	1
	White				2XD 357 558-401	1
	Amber / Green	48 W (in each color mode)	96 LEDs (48 Amber + 48 Green)	Double Flash and Rotating	2XD 357 558-501	1
	Amber / Blue	48 W (Amber) 96 W (Blue)	80 LEDs (48 Amber + 32 Blue)		2XD 357 558-601	1

* Packaging unit (Content of the box: One beacon, one flat rubber, one nylon base plate, screws)