

**HELLA BLACK MAGIC**

## **LED MINI LIGHT BAR**

**MONTAGEANLEITUNG**  
**FERNSCHEINWERFER**  
**INSTALLATION INSTRUCTION**  
**DRIVING LAMPS**  
**INSTRUCTIONS DE MONTAGE**  
**PROJECTEURS LONGUE PORTÉE / FEU DE POSITION**  
**MONTERINGSANVISNING**  
**FJÄRRSTRÅLKASTARE**  
**MONTAGEHANDLEIDING**  
**VÉRSTRALERS**  
**INSTRUCCIONES DE MONTAJE**  
**FAROS DE LARGO ALCANCE**

**ISTRUZIONI DI MONTAGGIO**  
**PROIETTORI DI PROFONDITÀ**  
**ASENNUSOHJE**  
**LISÄKAUKOVALOT**  
**INSTRUÇÕES DE INSTALAÇÃO**  
**FARÓIS MÁXIMOS**  
**INSTRUKCJA MONTAŻU**  
**ŚWIATŁA DROGOWE**

تعليمات التركيب  
مصباح أمامية عالية الشعاع

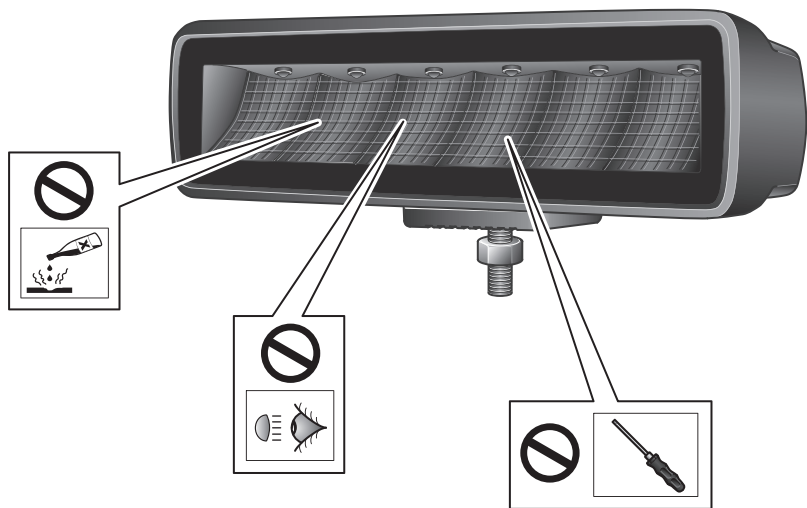

**DE PRODUKTHAFTUNG**

- Es sind die nationalen Anbau-, Einbau- und Betriebsvorschriften zu beachten und einzuhalten.
- Lesen Sie bitte vor Gebrauch des Gerätes alle beigelegten Anleitungen und Sicherheits-hinweise.
- Im Zuge von Produktverbesserung behalten wir uns technische und optische Änderungen vor.
- Verwenden Sie nur die Originalersatzteile bzw. nur Ersatzteile die von HELLA freigegeben sind.
- Bei Fragen oder Einbauproblemen, wenden Sie sich bitte an den HELLA Kundendienst, den Großhändler oder an Ihre Werkstatt.
- Weitere Informationen finden Sie auch auf unserer Internetseite ([www.hella.com/techworld](http://www.hella.com/techworld))

**EN PRODUCT LIABILITY**

- National mounting, fitting and operating regulations must be heeded and kept.
- Please read all the instructions and safety notes included before using the device.
- We reserve the right to make technical and optical modifications within the course of product improvement.
- Only use original spare parts or spare parts approved by HELLA.
- If you have any questions or problems with the installation, please contact HELLA Customer Services, a wholesaler or your garage.
- Further information is available on our website ([www.hella.com/techworld](http://www.hella.com/techworld))

**FR RESPONSABILITÉ PRODUIT**

- Les prescriptions nationales en matière de montage et de service doivent être observées et respectées.
- Avant d'utiliser l'appareil lire toutes les instructions de montage et de service fournies ainsi que les conseils de sécurité.
- Dans le cadre de l'amélioration continue de nos produits, nous nous réservons le droit de réaliser des modifications sur les plans technique et optique.
- Utilisez uniquement des pièces d'origine ou des pièces de rechange validées par HELLA.
- Pour toute question ou en cas de problèmes de montage, veuillez contacter le S.A.V. ou le distributeur HELLA ou bien vous adresser à votre garagiste.
- Vous trouverez également des informations complémentaires sur notre site Internet ([www.hella.com/techworld](http://www.hella.com/techworld))

**SV PRODUKTANSVAR**

- De nationella monterings-, installations- och driftföreskrifterna ska beaktas och följas.
- Läs alla medföljande instruktioner och säkerhetsanvisningar innan du använder apparaten.
- Vi förbehåller oss rätten till tekniska och optiska ändringar som förbättrar produkten.
- Använd endast original reservdelar resp. endast reservdelar som har godkänts av HELLA.
- Vid frågor eller monteringsproblem, kontakta HELLA kundtjänst, grossisten eller din verkstad.
- Mer information finns också på vår webbplats ([www.hella.com/techworld](http://www.hella.com/techworld))

**NL PRODUCTAANSPRAKELIJKHEID**

- Men dient de nationale aanbouw-, inbouw- en bedrijfsvoorschriften in acht te nemen en na te leven.
- Lees a.u.b. alvorens het apparaat te gebruiken alle bijgevoegde gebruiksaanwijzingen en veiligheidsinstructies door.
- In het kader van de productver-betering behouden wij ons technische en optische veranderingen voor.
- Gebruik uitsluitend de originele reserveonderdelen, die door Hella vrijgegeven zijn.
- Neem bij vragen of inbouwproblemen contact op met de HELLA klantenservice, de groothandel of het garagebedrijf.
- Meer informatie is ook te vinden op onze website ([www.hella.com/techworld](http://www.hella.com/techworld))

**ES RESPONSABILIDAD CIVIL POR PRODUCTOS DEFECTUOSOS**

- Tienen que observarse y cumplirse con las prescripciones nacionales sobre construcciones anexas, de montaje y de funcionamiento.
- Rogamos que antes de usar el aparato lean todas las instrucciones y advertencias sobre la seguridad adjuntas.
- En aras de la mejora de los productos, nos reservamos el derecho de hacer modificaciones técnicas y ópticas.
- Use sólo recambios originales o bien sólo recambios autorizados por HELLA.
- En caso de dudas o preguntas a la hora del montaje, llame al servicio de atención al cliente de HELLA o diríjase a su Distribuidor o Taller.
- Encontrará más información en nuestra página web ([www.hella.com/techworld](http://www.hella.com/techworld))

**IT RESPONSABILITÀ PER IL PRODOTTO**

- Si devono rispettare tutte le normative nazionali di attacco, montaggio e funzionamento.
- Prima di usare l'apparecchio, legga per favore tutte le istruzioni e le avvertenze di sicurezza allegate.
- Nell'ambito del perfezionamento del prodotto, ci riserviamo modifiche tecniche ed estetiche.
- Utilizzare solo pezzi di ricambio originali risp. pezzi autorizzati dalla HELLA.
- Per eventuali domande o problemi di installazione contattare l'Assistenza Clienti HELLA, il grossista o rivolgersi alla propria officina.
- Ulteriori informazioni sono disponibili anche sul nostro sito web ([www.hella.com/techworld](http://www.hella.com/techworld))

**FI TUOTEVASTUU**

- Kansalliset asennus- ja käyttöohjeet on huomioitava ja niitä on noudatettava.
- Lue ennen laitteen käyttöä kaikki oheistetut käyttö- sekä turvaohjeet.
- Jatkuvasta tuotekehittelystä johtuen pidätämme oikeuden teknisiin ja optisiin muutoksiin.
- Käytä vain alkuperäisiä tai HELLA hyväksymiä varaosia.
- Jos sinulla on kysyttävää tai asennusongelmia, käänny HELLA-asiakaspalvelun, tukkuliikkeen tai korjaamon puoleen.
- Lisätietoja löytyy verkkosivustoltamme ([www.hella.com/techworld](http://www.hella.com/techworld)).

**PT RESPONSABILIDADE DO PRODUTO**

- Devem ser cumpridas as prescrições nacionais que visam a montagem e a operação.
- Antes de utilizar o aparelho deve-se ler todas as instruções e avisos de segurança fornecidos.
- Reservamo-nos o direito de alterações técnicas e óticas no âmbito dos processos de melhoramento e de aperfeiçoamento dos produtos.
- Utilizar exclusivamente peças sobressalentes originais ou peças sobressalentes que tenham sido autorizadas e validadas pela HELLA.
- Contacte o serviço de assistência da HELLA, o revendedor grossista ou a oficina do seu concessionário, no caso de dúvidas ou problemas durante a montagem.
- Mais informações estão disponíveis em nosso site ([www.hella.com/techworld](http://www.hella.com/techworld))

## PL ODPOWIEDZIALNOŚĆ ZA PRODUKT

- Przestrzegać krajowych przepisów dotyczących montażu i użytkowania.
- Przed użyciem urządzenia przeczytać wszystkie dołączone instrukcje i zasady bezpieczeństwa.
- Zastrzegamy sobie prawo do wprowadzania zmian technicznych i wizualnych w ramach ulepszania produktu.
- Stosować wyłącznie oryginalne części zamienne lub części zamienne dopuszczone przez firmę HELLA.
- W razie pytań lub problemów z zamontowaniem należy skontaktować się z działem obsługi klienta firmy HELLA, ze sprzedawcą lub autoryzowanym warsztatem.
- Więcej informacji można również znaleźć na naszej stronie internetowej ([www.hella.com/techworld](http://www.hella.com/techworld))

## AR

### المسؤولية عن المنتج

- يجب الالتزام باللوائح المحلية السارية فيما يتعلق بالتركيب في الخارج أو في الداخل وبلوائح التشغيل.
- قبل استعمال الجهاز احرص على قراءة جميع الكتيبات المرفقة وإرشادات السلامة.
- لتطوير المنتجات فإننا نحتفظ بحق إدخال تغييرات تقنية وشكلية.
- يجب ألا تستخدم سوى قطع الغيار الأصلية أو قطع الغيار التي صرحت HELLA باستخدامها.
- إذا كان لديك أسئلة، أو إذا واجهت مشكلة أثناء التركيب، تفضل بالاتصال بمركز خدمة HELLA، أو بتاجر الجملة أو توجه إلى الورشة الفنية التي تتعامل معها.
- يتوفر مزيد من المعلومات على موقعنا ([www.hella.com/techworld](http://www.hella.com/techworld))

**DE** Technische Änderungen vorbehalten

**EN** Subject to alteration without notice

**FR** Sous réserve de modifications techniques

**SV** Vi reserverar oss för tekniska ändringar

**NL** Technische wijzigingen voorbehouden

**ES** Reservadas modificaciones técnicas

**IT** Con riserva di modifiche tecniche

**FI** Oikeus teknisiin muutoksiin pidätetään

**PT** Sujeitas a alteração sem aviso prévio

**PL** Podlega zmianom bez powiadamiania

نحتفظ بحق إجراء تغييرات فنية دون إخطار مسبق **AR**

**Zeichenerklärung**  
**Explanation symbols**  
**Explication des symboles**  
**Symbolförklaring**

**Legenda**  
**Aclaración de símbolos**  
**Legenda**  
**Piirroksen selitys**

**Símbolos de explicação**  
**Objasňenie symboli**

شرح الرموز



**(DE)** Richtig

**(EN)** Correct

**(FR)** Correct

**(SV)** Rätt

**(NL)** Goed

**(ES)** Correcto

**(IT)** Giusto

**(FI)** Oikein

**(PT)** Correcto

**(PL)** Prawidłowo

صحيح **(AR)**

**(DE)** Falsch

**(EN)** Incorrect

**(FR)** Incorrect

**(SV)** Fel

**(NL)** Fout

**(ES)** Erróneo

**(IT)** Sbagliato

**(FI)** Väärin

**(PT)** Incorreto

**(PL)** Nieprawidłowo

خطأ **(AR)**

**(DE)** Positionspfeil

**(EN)** Location/Position Arrow

**(FR)** Flèche de Position

**(SV)** Positionpil

**(NL)** Lokatie/Positie pijl

**(ES)** Flecha de posición

**(IT)** Freccia di posizione

**(FI)** Paikannusnuoli

**(PT)** Seta de localização/posição

**(PL)** Strzałka lokalizacji/położenia

سهم الموقع/المكان **(AR)**

**(DE)** Bewegungspfeil

**(EN)** Movement Arrow

**(FR)** Flèche indiquant

sens du mouvement

**(SV)** Rörelsepil

**(NL)** Richtingspijl

**(ES)** Flecha de movimiento

**(IT)** Freccia di movimento

**(FI)** Liikesuuntanuoli

**(PT)** Seta de movimento

**(PL)** Strzałka ruchu

سهم اتجاه الحركة **(AR)**



**Zeichenerklärung**  
**Explanation symbols**  
**Explication des symboles**  
**Symbolförklaring**

**Legenda**  
**Aclaración de símbolos**  
**Legenda**  
**Piirroksen selitys**

**Símbolos de explicação**  
**Objasňenie symboli**

شرح الرموز



**(DE)** Achtung  
**(EN)** Warning  
**(FR)** Attention  
**(SV)** Varning  
**(NL)** Let op  
**(ES)** Atención  
**(IT)** Attenzione  
**(FI)** Huomio  
**(PT)** Aviso  
**(PL)** Ostrzeżenie  
**(AR)** تحذير



**(DE)** Abklemmen  
**(EN)** Disconnect  
**(FR)** Déconnecter  
**(SV)** Koppla los  
**(NL)** Demonteren  
**(ES)** Desconectar  
**(IT)** Staccare  
**(FI)** Irrota  
**(PT)** Desligar  
**(PL)** Rozłącz  
**(AR)** افصل



**(DE)** Verbinden  
**(EN)** Connect  
**(FR)** Connecter  
**(SV)** Anslut  
**(NL)** In elkaar  
**(ES)** Conectar  
**(IT)** Collegare  
**(FI)** Yhdistä  
**(PT)** Ligar  
**(PL)** Połączyć  
**(AR)** وصل



**(DE)** Siehe  
**(EN)** Look/See  
**(FR)** Voir  
**(SV)** Se  
**(NL)** Kijkken naar  
**(ES)** Ver  
**(IT)** Vedere  
**(FI)** Katso  
**(PT)** Ver  
**(PL)** Zobacz/patrz  
**(AR)** انظر

**Zeichenerklärung**  
**Explanation symbols**  
**Explication des symboles**  
**Symbolförklaring**

**Legenda**  
**Aclaración de símbolos**  
**Legenda**  
**Piirroksen selitys**

**Símbolos de explicação**  
**Objasnienie symboli**

شرح الرموز



- (DE)** Nur Fachpersonal
- (EN)** Only qualified personnel
- (FR)** Personnel qualifié uniquement
- (SV)** Endast fackpersonal
- (NL)** Alleen gekwalificeerd personeel
- (ES)** Solo personal cualificado
- (IT)** Solo personale specializzato
- (FI)** Vain ammattilaiset
- (PT)** Apenas pessoal qualificado
- (PL)** Tylko wykwalifikowany personel
- (AR)** الموظفين المؤهلين فقط

Lieferumfang  
Scope of delivery  
Fourniture  
Leveransomfattning

Leveringsomvang  
Alcance de suministro  
Contenuto della confezione  
Toimituksen sisältö

Volume de fornecimento  
Elementy zestawu

الأجزاء المُورَدَة

**1FB 358 176-201**



**1FB 358 176-211**



**1FB 358 176-221**



Zubehör  
Accessories  
Accessories  
Tillbehör

Toebehoren  
Accessorios  
Accessori  
Lisätarvikkeet

Acessórios  
Akcesoria

الملحقات التكميلية



**8KW 732 580-003**



**8KW 732 567-003**



**1A 8JS 711 683 - 831**

**2A 8JS 711 683 - 841**

**3A 8JS 711 683 - 821**

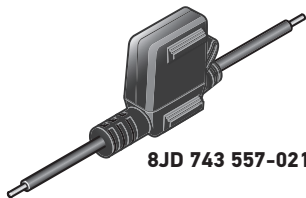

**8JD 743 557-021**

**Benötigte Montagewerkzeuge**  
Installation tools required  
Outillage de montage requis  
Nödvändiga monteringsverktyg

**Benodigde montagewerktuigen**  
Herramientas de montaje necesarias  
Attrezzi necessari per il montaggio  
Tarvittavat asennustyökalut

**Ferramentas de instalação necessárias**  
Wymagane narzędzia montażowe  
أدوات التركيب المطلوبة

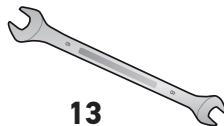

13



Ø7 mm

Ø9 mm



4



13

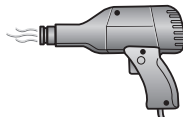
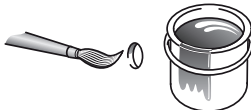
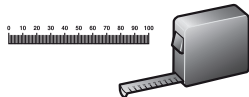
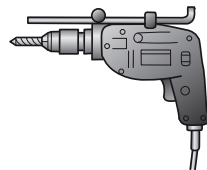

Montage  
Mounting  
Montage Général  
Montering

Montage  
Montaje  
Montaggio  
Asennus

Montagem  
Mocowanie

التركيب

**1FB 358 176-201**

**1FB 358 176-211**

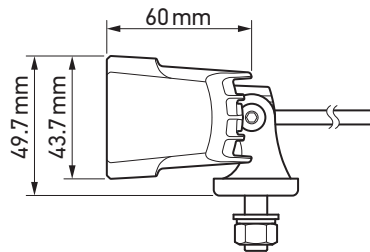
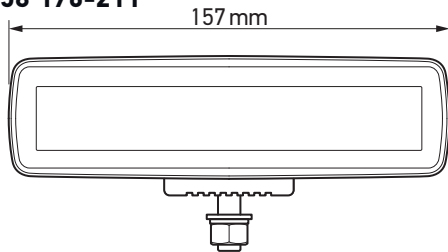

**1FB 358 176-221**

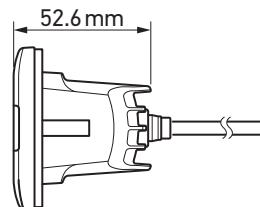
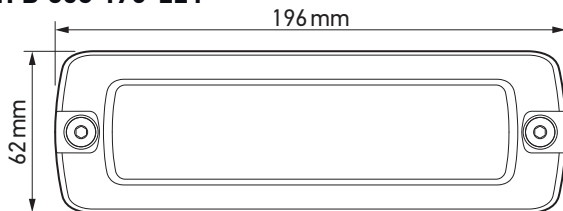

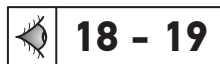
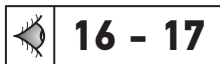

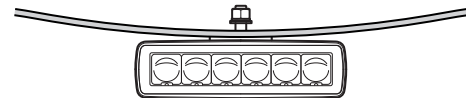
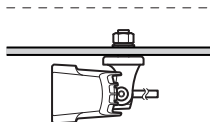
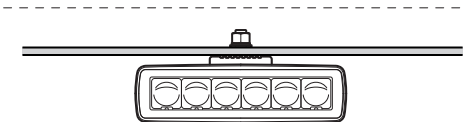
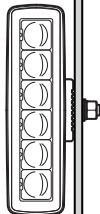



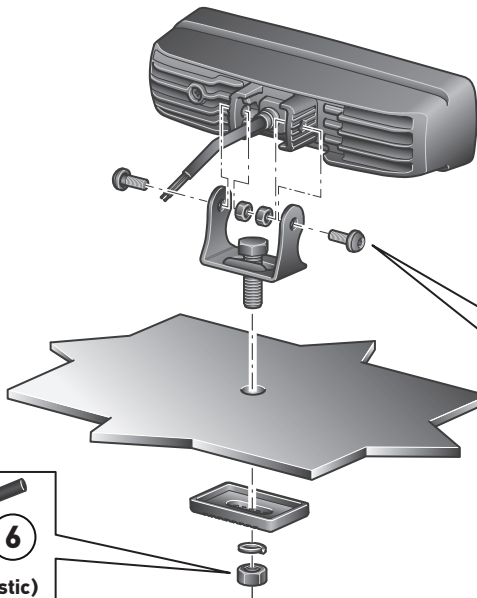
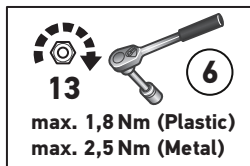
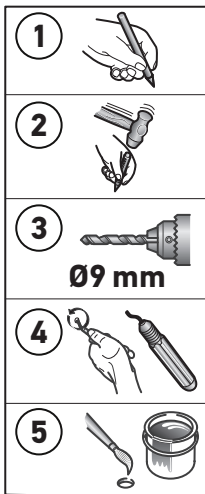

<b>DE</b>	(Metall)	(Kunststoff)
<b>EN</b>	(Metal)	(Plastic)
<b>FR</b>	(Métal)	(Plastique)
<b>SV</b>	(Metall)	(Plast)
<b>NL</b>	(Metaal)	(Kunststof)
<b>ES</b>	(Metal)	(Plástico)
<b>IT</b>	(Metallo)	(Plastica)
<b>FI</b>	(Metalli)	(Muovi)
<b>PT</b>	(Metal)	(Plástico)
<b>PL</b>	(Metal)	(Plastikowy)
<b>AR</b>	(معادن)	(بلاستيك)

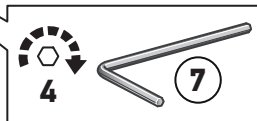

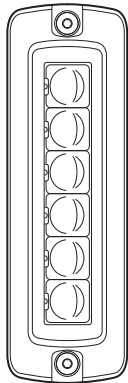
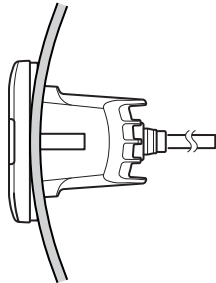
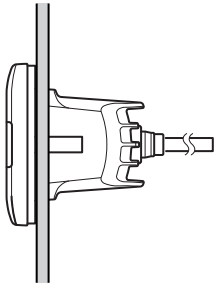
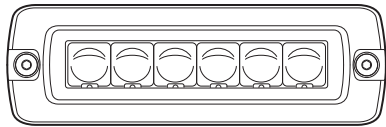
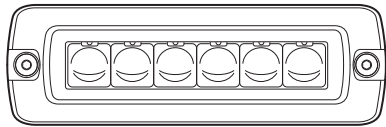

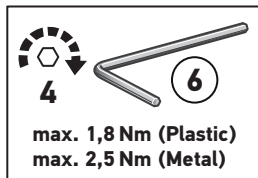
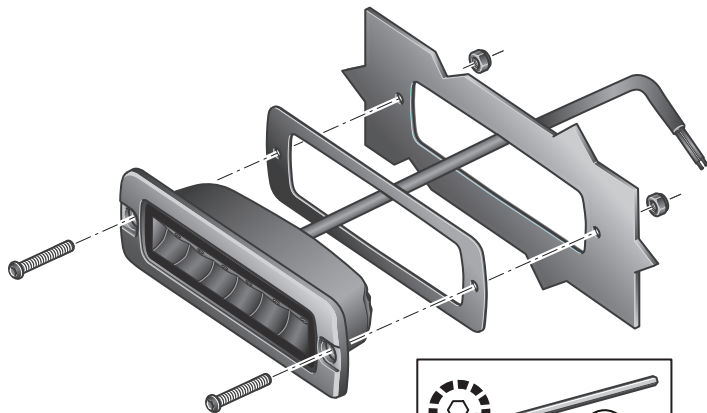
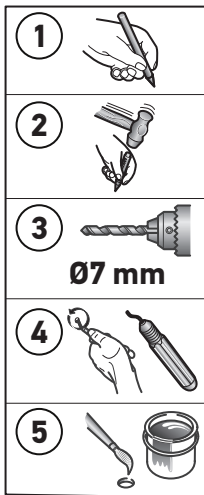

<b>DE</b> (Metall)	(Kunststoff)	<b>NL</b> (Metaal)	(Kunststof)	<b>PT</b> (Metal)	(Plástico)
<b>EN</b> (Metal)	(Plastic)	<b>ES</b> (Metal)	(Plástico)	<b>PL</b> (Metal)	(Plastikowy)
<b>FR</b> (Métal)	(Plastique)	<b>IT</b> (Metallo)	(Plastica)	<b>AR</b> (معدن)	(بلاستيك)
<b>SV</b> (Metall)	(Plast)	<b>FI</b> (Metalli)	(Muovi)		

Elektrischer Anschluss  
Electrical connection  
Branchement électrique  
Elektrisk anslutning

Elektrische aansluiting  
Conexión eléctrica  
Collegamento elettrico  
Osaluettelo

Ligação eléctrica  
Połączenia elektryczne  
الوصلة الكهربائية



+

rot  
red  
rouge  
röd  
rood  
rojo  
rosso  
punainen  
vermelho  
czzerwony

أحمر

-

schwarz  
black  
noir  
svart  
zwart  
negro  
nero  
musta  
preto  
czarny

أسود

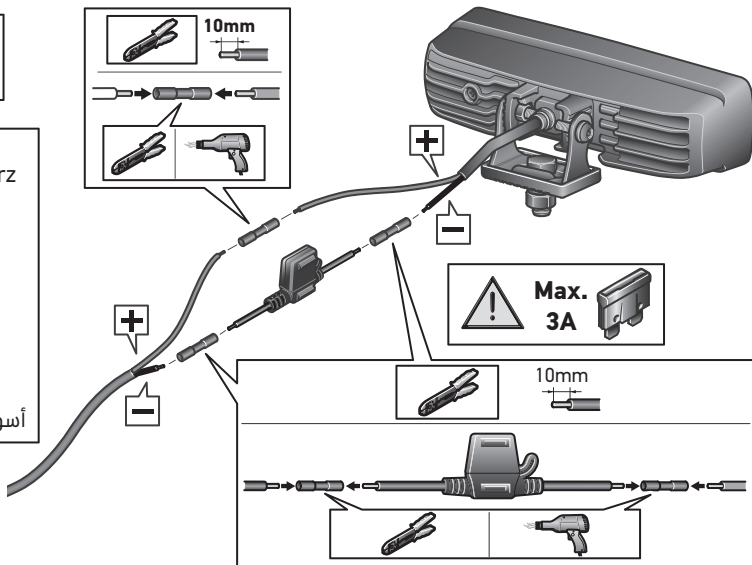
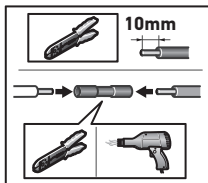

Max.  
3A



<b>DE</b>	Informationstext	22
<b>EN</b>	Information Text	22
<b>FR</b>	Texte d'information	22
<b>SV</b>	Informationstext	23
<b>NL</b>	Informatie tekst	23
<b>ES</b>	Texto informativo	23
<b>IT</b>	Informazioni	24
<b>FI</b>	Ohjetekstit	24
<b>PT</b>	Texto informativo	24
<b>PL</b>	Tekst informacyjny	25

**DE TECHNISCHE DATEN**

	Nennspannung	Spannungsbereich	Eingangswerte	Zulässige Umgebungstemperatur	Schutzklasse
1FB 358 176-201	12V	10 - 30V	2.6A	-40° C bis +60° C	IP68 IP69K
1FB 358 176-211	24V		1.3A		
1FB 358 176-221					

Der Betrieb der Leuchte mit Wechselspannung oder getakteter Gleichspannung ist nicht zulässig!

**EN TECHNICAL DATA**

	Nominal voltage	Range of voltage	Input values	Admissible ambient temperature	Class of protection
1FB 358 176-201	12V	10 - 30V	2.6A	-40°C up to +60°C	IP68 IP69K
1FB 358 176-211	24V		1.3A		
1FB 358 176-221					

Operation of the light using alternating voltage or clocked direct voltage is not permitted!

**FR DOCUMENT TECHNIQUE**

	Tension nominale	Plage de tension	Valeurs d'entrée	Température ambiante admissible	Classe de protection
1FB 358 176-201	12V	10 - 30V	2.6A	-40°C à +60°C	IP68 IP69K
1FB 358 176-211	24V		1.3A		
1FB 358 176-221					

Le fonctionnement du feu avec une tension alternative ou une tension continue cadencée n'est pas admis!

**SV** TEKNISKA DATA

	Märkspänning	Spänningsområde	Ingångsvärden	Tillåten omgivningstemperatur	Skyddsklass
1FB 358 176-201	12V	10 - 30V	2.6A	-40°C upp till +60°C	IP68 IP69K
1FB 358 176-211	24V		1.3A		
1FB 358 176-221					

Lampan får inte användas med växelspänning eller taktad likspänning!

**NL** TECHNISCHE GEGEVENS

	Nominale spanning	Spanningsbereik	Ingangswaarden	Toegestane omgevingstemperatuur	Beschermklasse
1FB 358 176-201	12V	10 - 30V	2.6A	-40°C tot +60°C	IP68 IP69K
1FB 358 176-211	24V		1.3A		
1FB 358 176-221					

Het gebruik van de lamp met wisselspanning of getacte gelijkspanning is niet toegestaan!

**ES** DATOS TÉCNICOS

	Tensión nominal	Margen de tensión	Valores de entrada	Temperatura ambiente admisible	Clase de protección
1FB 358 176-201	12V	10 - 30V	2.6A	-40°C hasta +60°C	IP68 IP69K
1FB 358 176-211	24V		1.3A		
1FB 358 176-221					

¡No es admisible el funcionamiento de las luces con corriente alterna o corriente continua sincronizada!

**IT DATI TECNICI**

	Tensione nominale	Intervallo di tensione	Valori di ingresso	Temperatura ambiente ammessa	Categoria di protezione
1FB 358 176-201	12V 24V	10 - 30V	2.6A	da -40°C a +60°C	IP68 IP69K
1FB 358 176-211			1.3A		
1FB 358 176-221					

Non è consentito attivare i fanali con tensione alternata o tensione continua ciclica!

**FI TEKNISET TIEDOT**

	Nimellisjännite	Jännitealue	Tuloarvot	Sallittu ympäristölämpötila	Kotelointiluokka
1FB 358 176-201	12V 24V	10 - 30V	2.6A	-40°C ... +60°C	IP68 IP69K
1FB 358 176-211			1.3A		
1FB 358 176-221					

Valoa ei saa käyttää vaihtojännitteellä eikä tahdistetulla tasajännitteellä!

**PT DADOS TÉCNICOS**

	Tensão nominal	Gama de tensão	Valores de entrada	Temperatura ambiente admissível	Classe de proteção
1FB 358 176-201	12V 24V	10 - 30V	2.6A	-40 °C até +60 °C	IP68 IP69K
1FB 358 176-211			1.3A		
1FB 358 176-221					

Não é permitido o funcionamento da lâmpada com tensão alternada ou com tensão contínua por impulso!



**PL DANE TECHNICZNE**

	Napięcie znamionowe	Zakres napięcia	Wartości wejściowe	Dopuszczalna temperatura otoczenia	Stopień ochrony
1FB 358 176-201	12V	10 - 30V	2.6A	-40° C do +60° C	IP68 IP69K
1FB 358 176-211	24V		1.3A		
1FB 358 176-221					

Lampy nie wolno zasilać ze źródła napięcia przemiennego ani napięcia stałego impulsowego!

**AR****المواصفات الفنية**

فئة الحماية	درجة حرارة الجو المسموح بها	قيم الدخل	مدى الجهد	الجهد الاسمي	
IP68 IP69K	من -40° م إلى +60° م	2.6A	10 - 30V	12V	1FB 358 176-201
		1.3A		24V	1FB 358 176-211
					1FB 358 176-221

غير مسموح بتشغيل اللامبات بواسطة تيار متردد أو تيار متردد عن طريق مهايات للجهد!

**DE** Beleuchtungsanlage auf einwandfreie Funktion hin prüfen

**EN** Check that the lighting system is working perfectly

**FR** Contrôler le bon fonctionnement de l'installation d'éclairage

**SV** Kontrollera att ljussystemet fungerar felfritt

**NL** Controleer of de verlichting goed functioneert

26

**ES** Comprobar que el sistema de iluminación funciona impecablemente

**IT** Controllare la perfetta funzionalità dell'impianto di illuminazione

**FI** Tarkasta valaistusjärjestelmän toiminta

**PT** Verifique que o sistema de iluminação está a funcionar bem

**PL** Sprawdź, czy układ oświetlenia działa prawidłowo.

تأكد أن مجموعة الأضواء تعمل بشكل صحيح **AR**

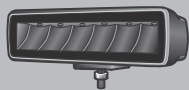

**HELLA GmbH & Co. KGaA**

Rixbecker Straße 75

59552 Lippstadt /Germany

[www.hella.com](http://www.hella.com)

© HELLA GmbH & Co. KGaA, Lippstadt

460 881-91 /05.21