

**MONTAGEANLEITUNG**  
RÜCKFAHRSCHINWERFER MODUL 70 LED

**INSTALLATION INSTRUCTION**  
REVERSE LIGHT MODUL 70 LED

**INSTRUCTIONS DE MONTAGE**  
PROJECTEUR DE REcul MODUL 70 LED

**MONTERINGSANVISNING**  
BACKSTRÅLKASTARE MODUL 70 LED

**MONTAGEHANDLEIDING**  
ACHTERUITRIJLAMP MODUL 70 LED

**INSTRUCCIONES DE MONTAJE**  
LUZ DE MARCHA ATRÁS MODUL 70 LED

**ISTRUZIONI DI MONTAGGIO**  
LUCI RETROMARCIA MODUL 70 LED

**ASENNUSOHJE**  
PERUUTUSVALOON MODUL 70 LED

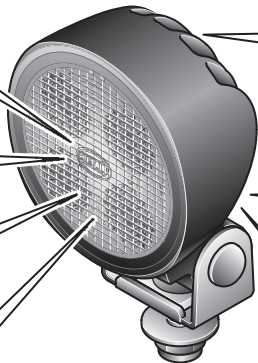
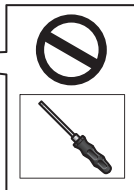
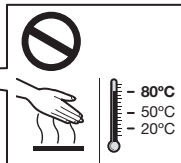
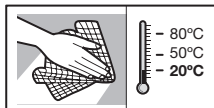

**Vor Steinschlag geschützt montieren!**  
**Mount protected against stone chipping!**  
**Monter à l'abri des chutes de pierres!**  
**Montera skyddat från stenskott!**  
**Tegen steenslag beschermd monteren!**  
**¡Montar de manera que quede protegido ante la acción de la gravilla!**  
**Montare in modo che sia protetto dall'urto di pietre!**  
**Asenna suojaan kiveniskuilta!**



**Scheinwerfer darf nicht abgedeckt werden.**  
**Headlamp must not be covered.**  
**Ne pas recouvrir le projecteur**  
**Strålkastaren får inte täckas över.**  
**Schijnwerper mag niet worden afgedekt.**  
**El faro no deberá taparse.**  
**Non coprire il faro.**  
**Valoa ei saa peittää.**

**Produkthaftung**

- Es sind die nationalen Anbau-, Einbau- und Betriebsvorschriften zu beachten und einzuhalten.
- Lesen Sie bitte vor Gebrauch des Gerätes alle beigelegten Anleitungen und Sicherheitshinweise.
- Im Zuge von Produktverbesserung behalten wir uns technische und optische Änderungen vor.
- Verwenden Sie nur die Originalersatzteile bzw. nur Ersatzteile die von HELLA freigegeben sind.
- Bei Fragen oder Einbauproblemen, rufen Sie den HELLA Kundendienst, Großhändler oder wenden Sie sich an Ihre Vertragswerkstatt.

**Product liability**

- National mounting, fitting and operating regulations must be heeded and kept.
- Please read all the instructions and safety notes included before using the device.
- We reserve the right to make technical and optical modifications within the course of product improvement.
- Only use original spare parts or spare parts approved by HELLA.
- If you have any questions or installation problems, call HELLA customer services, your wholesaler or contact your specialist garage.

**Responsabilité produit**

- Les prescriptions nationales en matière de montage et de service doivent être observées et respectées.
- Avant d'utiliser l'appareil lire toutes les instructions de montage et de service fournies ainsi que les conseils de sécurité.
- Dans le cadre de l'amélioration continue de nos produits, nous nous réservons le droit de réaliser des modifications sur les plans technique et optique.
- Utilisez uniquement des pièces d'origine ou des pièces de rechange validées par HELLA.
- Pour tous renseignements ou problèmes de montage, contactez le S.A.V. HELLA, votre distributeur ou votre garage lié par contrat.

**Produktansvar**

- De nationella monterings-, installations- och driftföreskrifterna ska beaktas och följas.
- Läs alla medföljande instruktioner och säkerhetsanvisningar innan du använder apparaten.
- Vi förbehåller oss rätten till tekniska och optiska ändringar som förbättrar produkten.
- Använd endast original reservdelar resp. endast reservdelar som har godkänts av HELLA.
- Om du har frågor eller problem med installationen, ring HELLA kundtjänst, partihandlaren eller vänd dig till din märkesverkstad.

**Productaansprakelijkheid**

- Men dient de nationale aanbouw-, inbouw- en bedrijfsvoorschriften in acht te nemen en na te leven.
- Lees a.u.b. alvorens het apparaat te gebruiken alle bijgevoegde gebruiksaanwijzingen en veiligheidsinstructies door.
- In het kader van de productverbetering behouden wij ons technische en optische veranderingen voor.
- Gebruik uitsluitend de originele reserveonderdelen, die door Hella vrijgegeven zijn.
- Bij vragen of inbouwproblemen dient u de HELLA klantenservice, de groothandel te bellen of u te richten tot de dealerwerkplaats.

**Responsabilidad civil por productos defectuosos**

- Tienen que observarse y cumplirse con las prescripciones nacionales sobre construcciones anexas, de montaje y de funcionamiento
- Rogamos que antes de usar el aparato lean todas las instrucciones y advertencias sobre la seguridad adjuntas.
- En aras de la mejora de los productos, nos reservamos el derecho de hacer modificaciones técnicas y ópticas.
- Use sólo recambios originales o bien sólo recambios autorizados por HELLA.
- Si tiene preguntas que hacer nos o dificultades en el montaje, llame al Servicio de Atención al Cliente de HELLA, a los mayoristas o diríjase a su taller concesionario.

**Responsabilità per il prodotto**

- Si devono rispettare tutte le normative nazionali di attacco, montaggio e funzionamento.
- Prima di usare l'apparecchio, legga per favore tutte le istruzioni e le avvertenze di sicurezza allegate.
- Nell'ambito del perfezionamento del prodotto, ci riserviamo modifiche tecniche ed estetiche.
- Utilizzare solo pezzi di ricambio originali risp. pezzi autorizzati dalla HELLA.
- In caso di domande o problemi di montaggio, chiami il servizio di assistenza dei clienti della HELLA, il rivenditore o si rivolga alla Sua officina autorizzata.

**Tuotevastuu**

- Kansalliset asennus- ja käyttöohjeet on huomioitava ja niitä on noudatettava.
- Lue ennen laitteen käyttöä kaikki oheistetut käyttö- sekä turvaohjeet.
- Jatkuvasta tuotekehittelystä johtuen pidätämme oikeuden teknisiin ja optisiin muutoksiin.
- Käytä vain alkuperäisiä tai HELLA hyväksymiä varaosia.
- Jos Sinulla on kysymyksiä tai asennusongelmia, soita HELLA-asiakaspalveluun, tukkukauppiaille tai käänny sopimuskorjaamon puoleen.

**DE** Technische Änderungen vorbehalten

**EN** Subject to alteration without notice

**FR** Sous réserve de modifications techniques

**SV** Vi reserverar oss för tekniska ändringar

**NL** Technische wijzigingen voorbehouden

**ES** Reservadas modificaciones técnicas

**IT** Con riserva di modifiche tecniche

**FI** Oikeus teknisiin muutoksiin pidätetään

**Zeichenerklärung**  
**Explanation symbols**  
**Explication des symboles**

**Symbolförklaring**  
**Legenda**  
**Aclaración de símbolos**

**Legenda**  
**Piirroksen selitys**



- (DE)** Richtig
- (EN)** Correct
- (FR)** Correct
- (SV)** Rätt
- (NL)** Goed
- (ES)** Correcto
- (IT)** Giusto
- (FI)** Oikein



- (DE)** Falsch
- (EN)** Incorrect
- (FR)** Incorrect
- (SV)** Fel
- (NL)** Fout
- (ES)** Erróneo
- (IT)** Sbagliato
- (FI)** Väärin



- (DE)** Positionspfeil
- (EN)** Location/Position Arrow
- (FR)** Flèche de Position
- (SV)** Positionpil
- (NL)** Lokatie/Positie pijl
- (ES)** Flecha de posición
- (IT)** Freccia di posizione
- (FI)** Paikannusnuoli



- (DE)** Bewegungspfeil
- (EN)** Movement Arrow
- (FR)** Flèche indiquant sens du vouvement
- (SV)** Rörelsepil
- (NL)** Richtingspijl
- (ES)** Flecha de moviemento
- (IT)** Freccia di movimentov
- (FI)** Liikesuuntanuoli



- (DE)** Achtung
- (EN)** Warning
- (FR)** Attention
- (SV)** Varning
- (NL)** Let op
- (ES)** Atención
- (IT)** Attenzione
- (FI)** Huomio



- (DE)** Abklemmen
- (EN)** Disconnect
- (FR)** Déconnecter
- (SV)** Koppla los
- (NL)** Demonteren
- (ES)** Desconectar
- (IT)** Staccare
- (FI)** Irrota



- (DE)** Verbinden
- (EN)** Connect
- (FR)** Connecter
- (SV)** Anslut
- (NL)** In elkaar
- (ES)** Conectar
- (IT)** Collegare
- (FI)** Yhdistä



- (DE)** Siehe
- (EN)** Look/See
- (FR)** Voir
- (SV)** Se
- (NL)** Kijkjen naar
- (ES)** Ver
- (IT)** Vedere
- (FI)** Katso

**Lieferumfang**  
**Scope of delivery**  
**Fourniture**

**Leveransomfattning**  
**Leveringsomvang**  
**Alcance de suministro**

**Contenuto della confezione**  
**Toimituksen sisältö**

**Modul 70 LED**  
**2ZR 996 376-XXX**  
**2ZR 996 576-XXX**





Zubehör  
Accessories  
Accessories

Tillbehör  
Toebehoren  
Accessorios

Accessori  
Lisätarvikkeet



3A 8JS 711 683-821

2A 8JS 711 683-841



8JD 005 235-801

**Benötigte Montagewerkzeuge**  
Installation tools required  
Outillage de montage requis

**Nödvändiga monteringsverktyg**  
Benodigde montagewerktuigen  
Herramientas de montaje necesarias

**Attrezzi necessari per il montaggio**  
Tarvittavat asennustyökalut



**13 / 16 / 17**



**Ø10,5 mm**

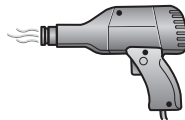
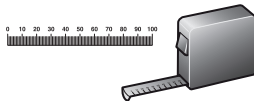
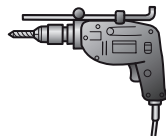
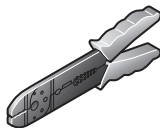

Anbauscheinwerfer  
Surface-mounted worklamp  
Projecteur pour montage appliqué

Ytmonterad strålkastare  
Aanbouwschijnwerper  
Faro para el montaje superficial

Faro per montaggio esterno  
Valonheitin pinta-asennukseen

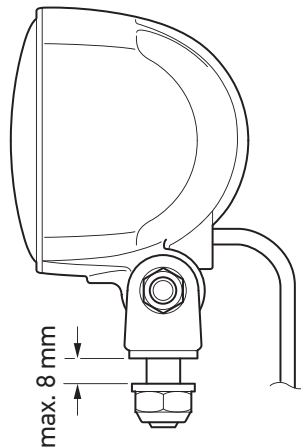
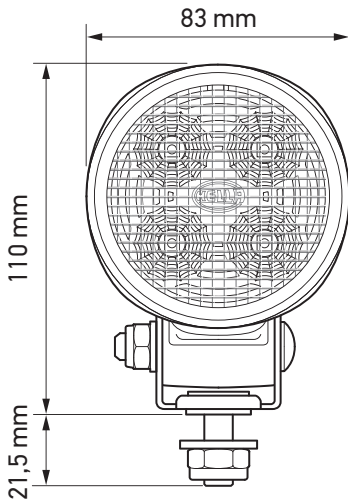

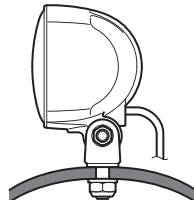
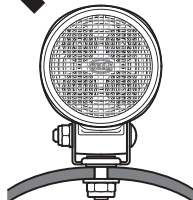
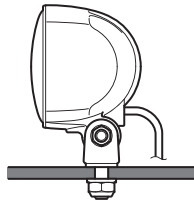
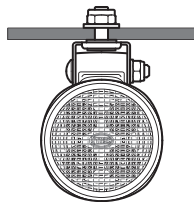
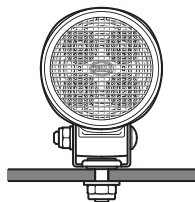

**2ZR 996 376-XXX (2ZR996.376) 18°**  
**2ZR 996 576-5XX (2ZR.2558) 37°**  
**2ZR 996 576-6XX (2ZR.2562) 32°**

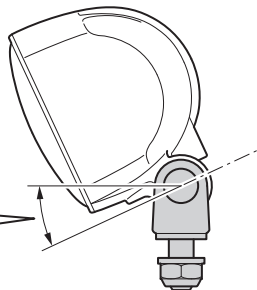

**2ZR 996 376-XXX (2ZR996.376) 18°**  
**2ZR 996 576-5XX (2ZR.2558) 37°**  
**2ZR 996 576-6XX (2ZR.2562) 32°**

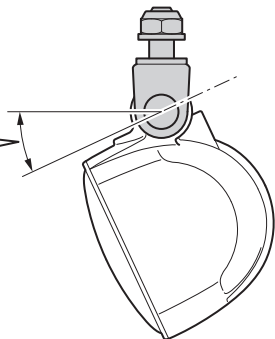



**ECE-R48**

min. 250 mm

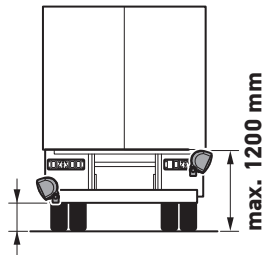

max. 1200 mm

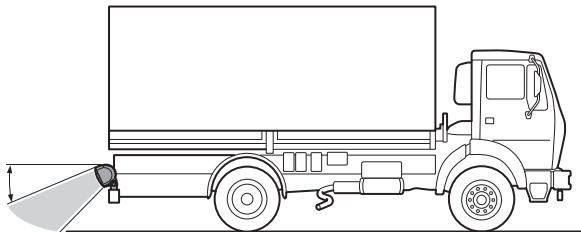
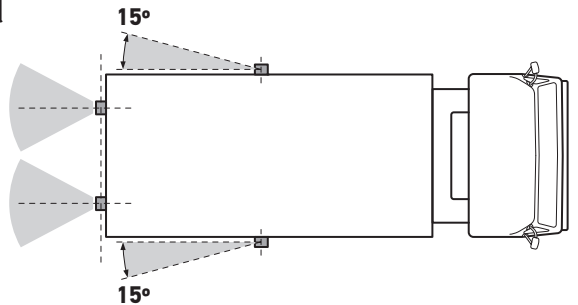
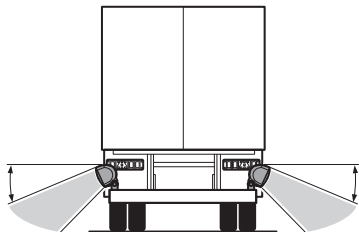

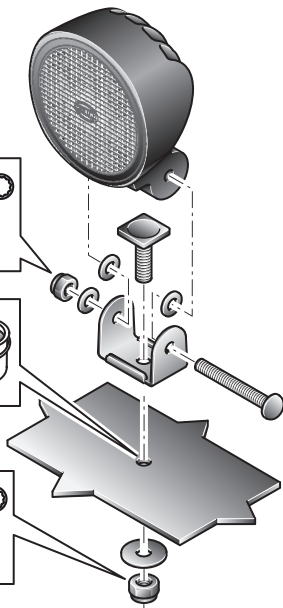
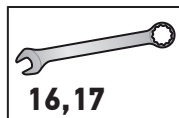
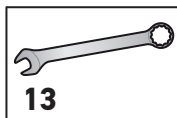
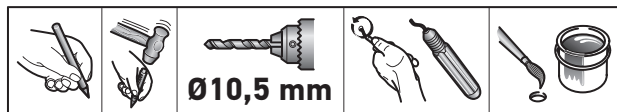

**Elektrischer Anschluss**  
**Electrical connection**  
**Branchement électrique**

**Elektrisk anslutning**  
**Elektrische aansluiting**  
**Conexión eléctrica**

**Collegamento elettrico**  
**Osaluettelo**

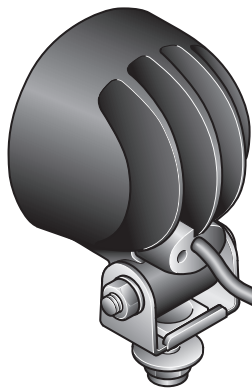

**+** weiß  
white  
blanc  
vit  
wit  
blanco  
bianco  
valkoinen

**12V/3A**  
**24V/2A**

**-** schwarz  
black  
noir  
svart  
zwart  
negro  
nero  
musta

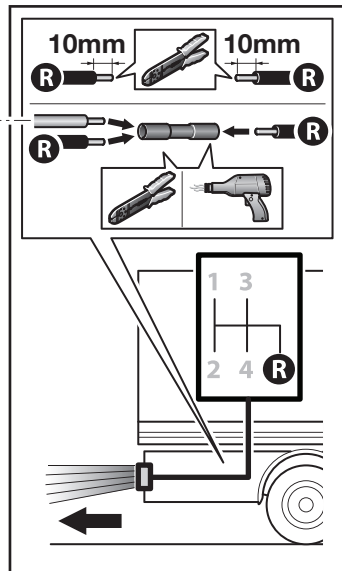



<b>DE</b>	Informationstext	18
<b>EN</b>	Information Text	18
<b>FR</b>	Texte d'information	19
<b>SV</b>	Informationstext	19
<b>NL</b>	Informatie tekst	20
<b>ES</b>	Texto informativo	20
<b>IT</b>	Informazioni	21
<b>FI</b>	Ohjetekstit	21

**DE TECHNISCHE DATEN**

	Nennspannung	Spannungsbereich	Eingangswerte	Zulässige Umgebungstemperatur	Schutzklasse IP 6K 9K
2ZR 996 376-XXX (2ZR996.376)	12V	9V - 16V	< 1,5 A < 13,5 W	-40° C bis +50° C	(Spritzwasser und Staub geschützt)
	24V	16V - 32V	< 0,9 A < 14,5 W		
2ZR 996 576-5XX (2ZR.2558)	12V	9V - 16V	< 2,3 A < 20,5 W		
	24V	16V - 32V	< 1,3 A < 20,0 W		
2ZR 996 576-6XX (2ZR.2562)	12V	9V - 16V	< 1,8 A < 15,0 W		
	24V	16V - 32V	< 1,0 A < 14,5 W		

**Der Betrieb der Leuchte mit Wechselspannung oder getakteter Gleichspannung ist nicht zulässig!**

**EN TECHNICAL DATA**

	Nominal voltage	Range of voltage	Input values	Admissible ambient temperature	Class of protection IP 6K 9K
2ZR 996 376-XXX (2ZR996.376)	12V	9V - 16V	< 1,5 A < 13,5 W	-40°C up to +50°C	(Protection against splash water and dust)
	24V	16V - 32V	< 0,9 A < 14,5 W		
2ZR 996 576-5XX (2ZR.2558)	12V	9V - 16V	< 2,3 A < 20,5 W		
	24V	16V - 32V	< 1,3 A < 20,0 W		
2ZR 996 576-6XX (2ZR.2562)	12V	9V - 16V	< 1,8 A < 15,0 W		
	24V	16V - 32V	< 1,0 A < 14,5 W		

**Operation of the light using alternating voltage or clocked direct voltage is not permitted!**

**FR DOCUMENT TECHNIQUE**

	Tension nominale	Valeurs d'entrée	Valeurs d'entrée	Température ambiante admissible	Classe de protection IP 6K 9K
2ZR 996 376-XXX (2ZR996.376)	12V	9V - 16V	< 1,5 A < 13,5 W	-40°C à +50°C	(Protection aux projections d'eau et à la poussière)
	24V	16V - 32V	< 0,9 A < 14,5 W		
2ZR 996 576-5XX (2ZR.2558)	12V	9V - 16V	< 2,3 A < 20,5 W		
	24V	16V - 32V	< 1,3 A < 20,0 W		
2ZR 996 576-6XX (2ZR.2562)	12V	9V - 16V	< 1,8 A < 15,0 W		
	24V	16V - 32V	< 1,0 A < 14,5 W		

**Le fonctionnement du feu avec une tension alternative ou une tension continue cadencée n'est pas admis!**

**SV TEKNISKA DATA**

	Märkspänning	Spänningssområde	Ingångsvärden	Tillåten omgivningstemperatur	Skyddsklass IP 6K 9K
2ZR 996 376-XXX (2ZR996.376)	12V	9V - 16V	< 1,5 A < 13,5 W	-40°C upp till +50°C	(Skydd mot stänkvatten och damm)
	24V	16V - 32V	< 0,9 A < 14,5 W		
2ZR 996 576-5XX (2ZR.2558)	12V	9V - 16V	< 2,3 A < 20,5 W		
	24V	16V - 32V	< 1,3 A < 20,0 W		
2ZR 996 576-6XX (2ZR.2562)	12V	9V - 16V	< 1,8 A < 15,0 W		
	24V	16V - 32V	< 1,0 A < 14,5 W		

**Lampan får inte användas med växelspanning eller taktad likspänning!**

**NL TECHNISCHE GEGEVENS**

	Nominale spanning	Spanningsbereik	Ingangswaarden	Toegestane omgevings-temperatuur	Beschermklasse IP 6K 9K
2ZR 996 376-XXX (2ZR996.376)	12V	9V - 16V	< 1,5 A < 13,5 W	-40°C tot +50°C	(Bescherming tegen spetterend water en stof)
	24V	16V - 32V	< 0,9 A < 14,5 W		
2ZR 996 576-5XX (2ZR.2558)	12V	9V - 16V	< 2,3 A < 20,5 W		
	24V	16V - 32V	< 1,3 A < 20,0 W		
2ZR 996 576-6XX (2ZR.2562)	12V	9V - 16V	< 1,8 A < 15,0 W		
	24V	16V - 32V	< 1,0 A < 14,5 W		

**Het gebruik van de lamp met wisselspanning of getacte gelijkspanning is niet toegestaan!**

**ES DATOS TÉCNICOS**

	Tensión nominal	Margen de tensión	Valores de entrada	Temperatura ambiente admisible	Clase de protección IP 6K 9K
2ZR 996 376-XXX (2ZR996.376)	12V	9V - 16V	< 1,5 A < 13,5 W	-40°C hasta +50°C	(Protección antisalpicaduras agua y polvo)
	24V	16V - 32V	< 0,9 A < 14,5 W		
2ZR 996 576-5XX (2ZR.2558)	12V	9V - 16V	< 2,3 A < 20,5 W		
	24V	16V - 32V	< 1,3 A < 20,0 W		
2ZR 996 576-6XX (2ZR.2562)	12V	9V - 16V	< 1,8 A < 15,0 W		
	24V	16V - 32V	< 1,0 A < 14,5 W		

**¡No es admisible el funcionamiento de las luces con corriente alterna o corriente continua sincronizada!**

**IT DATI TECNICI**

	Tensione nominale	Intervallo di tensione	Valori di ingresso	Temperatura ambiente ammessa	Categoria di protezione IP 6K 9K
2ZR 996 376-XXX (2ZR996.376)	12V	9V - 16V	< 1,5 A < 13,5 W	da -40°C a +50°C	(Protezione contro spruzzi d'acqua e polvere)
	24V	16V - 32V	< 0,9 A < 14,5 W		
2ZR 996 576-5XX (2ZR.2558)	12V	9V - 16V	< 2,3 A < 20,5 W		
	24V	16V - 32V	< 1,3 A < 20,0 W		
2ZR 996 576-6XX (2ZR.2562)	12V	9V - 16V	< 1,8 A < 15,0 W		
	24V	16V - 32V	< 1,0 A < 14,5 W		

**Non è consentito attivare i fanali con tensione alternata o tensione continua ciclica!**

**FI TEKNISET TIEDOT**

	Nimellisjännite	Jännitealue	Tuloarvot	Sallittu ympäristölämpötila	Kotelointiluokka IP 6K 9K
2ZR 996 376-XXX (2ZR996.376)	12V	9V - 16V	< 1,5 A < 13,5 W	-40°C ... +50°C	(Suojattu pölyltä ja roiskevedeltä)
	24V	16V - 32V	< 0,9 A < 14,5 W		
2ZR 996 576-5XX (2ZR.2558)	12V	9V - 16V	< 2,3 A < 20,5 W		
	24V	16V - 32V	< 1,3 A < 20,0 W		
2ZR 996 576-6XX (2ZR.2562)	12V	9V - 16V	< 1,8 A < 15,0 W		
	24V	16V - 32V	< 1,0 A < 14,5 W		

**Valoa ei saa käyttää vaihtojännitteellä eikä tahdistetulla tasajännitteellä!**

**DE** Beleuchtungsanlage auf einwandfreie Funktion hin prüfen

**EN** Check that the lighting system is working perfectly

**FR** Contrôler le bon fonctionnement de l'installation d'éclairage

**SV** Kontrollera att ljussystemet fungerar felfritt

**NL** Controleer of de verlichting goed functioneert

**ES** Comprobar que el sistema de iluminación funciona impecablemente

**IT** Controllare la perfetta funzionalità dell'impianto di illuminazione

**FI** Tarkasta valaistusjärjestelmän toiminta

**DE** Bei Fragen oder Einbauproblemen, rufen Sie bitte den HELLA Kundendienst, Großhändler an oder wenden Sie sich an Ihre Werkstatt.

**EN** If you have questions or installation problems, please call the HELLA Service, wholesaler, or turn to your garage.

**FR** Pour toutes questions ou problèmes de montage, merci de contacter le service après-vente HELLA, votre distributeur ou votre garage.

**SV** Vid frågor eller monteringsproblem, kontakta Hellas kundtjänst, återförsäljaren eller din verkstad.

**NL** In geval van vragen of montageproblemen verzoeken wij u contact met de HELLA-klantenservice, de groothandel of uw dealer op te nemen.

**ES** En caso de dudas o problemas de montaje, por favor, llame al Servicio postventa de Hella o al mayorista, o bien dirijase a su taller.

**IT** Per qualsiasi domanda o problemi di montaggio si prega di contattare il servizio assistenza o il proprio grossista HELLA oppure di rivolgersi alla propria officina.

**FI** Jos sinulla on kysymyksiä tai asennusongelmia, soita HELLA-asiakaspalvelulle tai tukkuliikkeelle tai käänny korjaamon puoleen.

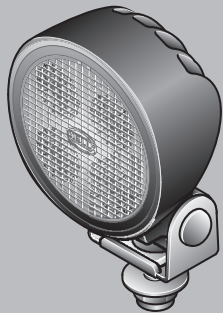

**HELLA GmbH & Co. KGaA**

Rixbecker Straße 75

59552 Lippstadt /Germany

[www.hella.com](http://www.hella.com)

© HELLA GmbH & Co. KGaA, Lippstadt

460 845-18 /01.19