



BRIEF INFORMATION

HELLA VALUEFIT SLIM beacons

- Beacon with slim design in the latest design trend
- Overvoltage and electronics protection
- Great value for money

PRODUCT FEATURES

The HELLA VALUEFIT SLIM beacon is available as an option for fixed surface mounting and as a version with flexible pipe socket mounting. The fixed surface mounting variant has an overall height of just 50 mm. The slim appearance blends in harmoniously with the vehicle design. The aluminium base plate ensures robustness and effective heat dissipation. The polycarbonate light dome is impact-resistant.

In addition, a variant with flexible pipe socket mounting is available. The shock-absorbing and vibration-damping base plate briefly tilts the beacon and cushions impacts. The base plate material is TPU (thermoplastic polyurethane) and the light dome is made of impact-resistant polycarbonate, as with the fixed surface mounting variant.

Protection classes IP 67 and IP 69K ensure that the lamp is insensitive to high-pressure jet cleaning.

TECHNICAL DETAILS



* only amber version

Technical data	
Rated voltage	Multi-voltage
Operating voltage	10 – 30 V
Current consumption*	2.1 A (12 V) 1 A (24 V)
Power consumption	24 W
Light function	Fixed surface mounting: Single and double flash function Flexible pipe socket mounting: double flash function
Light source	LED
Material	Fixed surface mounting: Aluminium base plate with polycarbonate dome Flexible pipe socket mounting: TPU pipe socket with polycarbonate dome
Weight (each without cable set)	Fixed surface mounting: Amber: 294 g, Green: 360 g Flexible pipe-socket mounting: Amber: 509 g, Green: 543 g
Temperature range	-40°C to +60°C
Degree of protection	IP 67, IP 69K
Type approval	Amber: ECE-R65 TA1, SAE J845 Class 1 Green: only SAE Class 3
EMC protection	ECE-R10
Number of LEDs	24
Cable length	300 mm with open ends
Mounting specification	Fixed surface mounting and flexible pipe socket mounting

* at max. power

Dimensional sketch

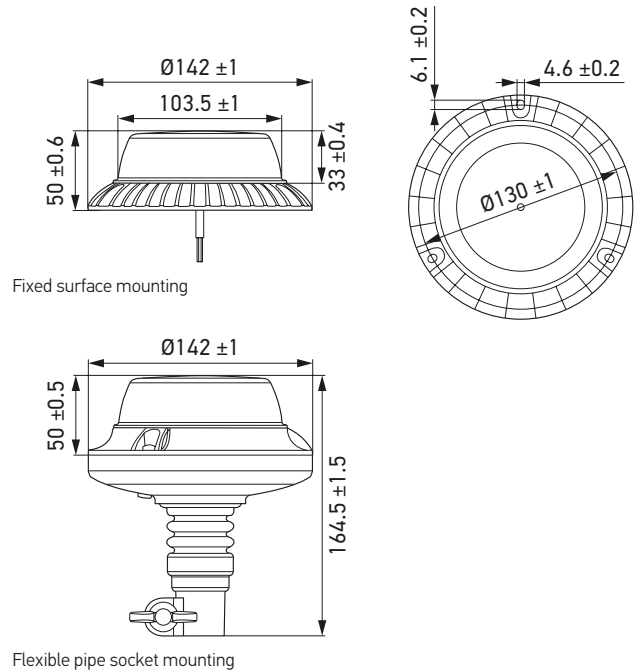









PROGRAM OVERVIEW

Product image	Type of mounting	Light function	Light colour	Part number
	Fixed surface mounting	Single and double flash	Amber	2XD 357 980-001
			Green*	2XD 357 980-101
	Flexible pipe socket mounting	Double flash	Amber	2XD 357 980-011
			Green*	2XD 357 980-111

* No ECE approval (R65) – use as far as permitted by legislation.
Not approved for public road traffic in the Federal Republic of Germany, Austria, and Switzerland.

ACCESSORIES

Product image	Description	Part number
	Latching changeover switch, 2-pin, 1 position	12 V: 6FH 353 100-031 24 V: 6FH 353 100-191
	Socket pipe for welding on, straight, 100 mm long, with rubber stopper and connector socket, in accordance with DIN 14620	1-pin: 8HG 002 365-001 2-pin: 8HG 006 294-101
	Socket pipe with screw-on base plate, total height 126 mm, with rubber stopper and connector socket, in accordance with DIN 14620	1-pin: 8HG 006 294-011 2-pin: on request
	Angled socket pipe with base plate for lateral screw attachment, clearance 90 mm, height 100 mm including rubber stopper, connector socket, 2x hexagon screws M8 x 35, 2x hexagon nuts M8, 2x spring washers, in accordance with DIN 14620	1-pin: 8HG 006 294-021 2-pin: on request
	Angled socket pipe with base plate for lateral screw attachment, clearance 50 mm, height 100 mm including rubber stopper, connector socket, 2x hexagon screws M8 x 35, 2x hexagon nuts M8, 2x spring washers, in accordance with DIN 14620	1-pin: 8HG 006 294-111 2-pin: on request
	Socket pipe for inclined screw-on surfaces, beacon adjustable parallel to the roadway, height approx. 105 mm, with rubber stopper, connector socket, 2x hexagon screws M8 x 35, 2x hexagon nuts M8, 2x spring washers, in accordance with DIN 14620	1-pin: 8HG 006 294-031 2-pin: 8HG 006 294-141
	Socket pipe with screw mounting, height approx. 100 mm, with rubber stopper and connector socket, in accordance with DIN 14620	1-pin: 8HG 006 294-051 2-pin: 8HG 006 294-091
	Socket pipe with 2 screw holes for surface mounting to the cab rear, with telescopic bracket, total height approx. 1,000 mm, can be shifted up to 700 mm, with rubber stopper and connector socket, compliant with DIN 14620	1-pin: 8HG 006 294-041 2-pin: on request