



## PRODUCT NEWS

### HELLA BST-Round Warning Light

- Set of two BST-Round flashers and one controller
- Various flashing patterns
- Day/night mode included
- Can be synchronised with multiple units
- Clear lens and different signal colours

### PRODUCT FEATURES

The BST-Round warning light is characterised by its new round design which allows flexible installation in different areas of the vehicle. Four power LEDs and high-quality precision optics generate an intensive warning signal with minimum power consumption.

The warning lights are supplied as a set, consisting of a controller, two flasher heads and two mounting rings. The power supply cable has an open end and the mounting rings and mounting brackets allow easy and flexible installation. The BST-Round warning light is extremely temperature resistant due to the high-quality aluminium housing and will operate in a temperature range of - 40°C to + 80°C. The warning lights have different flash patterns, e.g. single flash or double flash. Further details on the different flash sequences can be found in the assembly instructions.



The BST-Round warning lights are supplied as a pre-configured set.

# HELLA BST-Round Warning Light

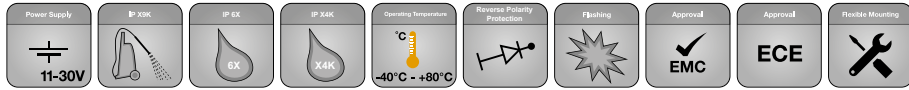





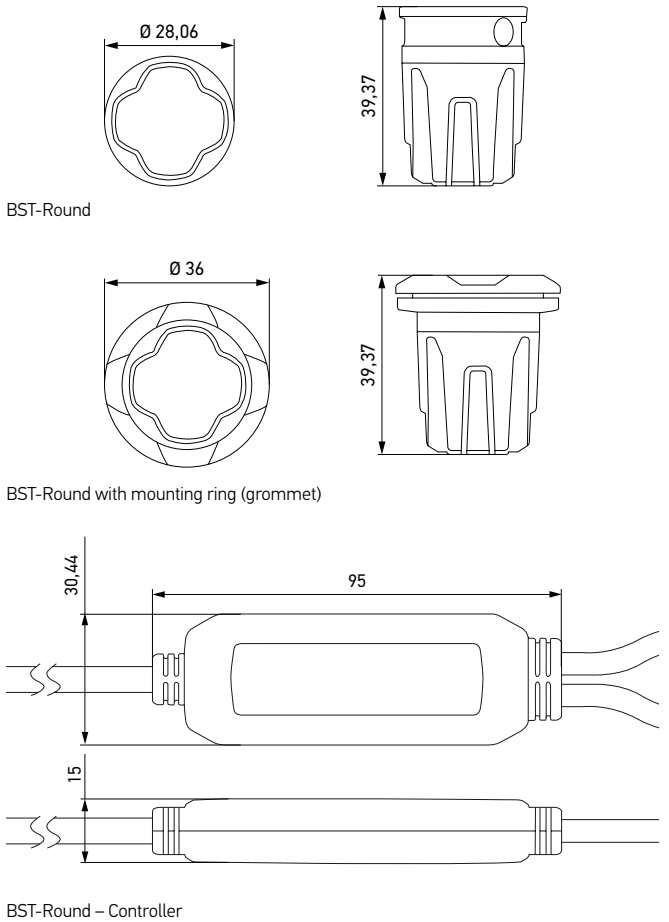

Technical data	
Rated voltage	Multi-voltage
Operating voltage	11 – 30V DC
Power consumption	2.27 – 2.75 A (12 V) 1.13 – 1.37 A (24 V)
Current consumption	27 – 33 W
Housing	Aluminium
Connection	Cable length: 180 mm from light head to connector, 790 mm from light head to controller, 1.850 mm from controller to power supply open end
Light source	LED
Weight	100 g
Temperature range	-40°C +80°C
Reverse Polarity Protection	Yes
Protection class	Lighthouse: IP 6X, IP X4K, IP X9K Controller: IP X7
EMC protection	ECE-R10, CISPR 25 Class 3
Type approval	ECE R65 For 2XD 014 564-801: SAE J845 Class 1

## Technical drawing



## RANGE OVERVIEW

Product Image	Description	Approval	Lens	Warning Signal	Part number
	BST-Round, 1 controller, 2 flasherheads, 2 grommets	ECE	Clear	Blue	<b>2XD 014 564-001</b>
	BST-Round, 1 controller, 2 flasherheads, 2 grommets	ECE	Clear	Amber	<b>2XD 014 564-211</b>
	BST-Round, 1 controller, 2 flasherheads, 2 grommets	ECE	Clear	Red	<b>2XD 014 564-601</b>
	BST-Round, 1 controller, 2 flasherheads, 2 grommets, SAE only	SAE	Clear	White	<b>2XD 014 564-801</b>
	BST-Round, 1 controller, 2 flasherheads, 2 grommets	ECE	Clear	Blue / Amber	<b>2XD 014 564-011</b>
	BST-Round, 1 controller, 2 flasherheads, 2 grommets	ECE	Clear	Blue / Red	<b>2XD 014 564-021</b>
	BST-Round, 1 controller, 2 flasherheads, 2 grommets	ECE	Clear	Red / Amber	<b>2XD 014 564-611</b>

## ACCESSORIES

	2 L-brackets				<b>9XD 863 533-101</b>
---	--------------	--	--	--	------------------------