



PAGID

BRAKE SYSTEMS

**RICAMBI
PER VEICOLI
ELETTRICI
E IBRIDI**

■ RELIANCE. TRUST. PERFORMANCE.

FRENATA SICURA PER VEICOLI ELETTRICI E IBRIDI



I nostri requisiti

Hella Pagid è uno dei fornitori leader di freni per il mercato indipendente dei ricambi con una vasta gamma di prodotti.

L'esperienza nello sviluppo di pastiglie freno OE di TMD Friction, la nostra casa madre, risale al lontano 1878 ed è oggi una certezza in termini di qualità, comfort e sicurezza ai massimi livelli. Ciò vale sia per le pastiglie PAGID OE che per le pastiglie Hella Pagid per il mercato indipendente dei ricambi.

Hella Pagid propone oltre 14.000 prodotti per quasi tutte le marche e tutti i modelli sul mercato. Hella Pagid offre le pastiglie freno giuste per oltre l'85% di tutti i modelli di veicoli elettrici e ibridi. Propone inoltre già oggi i dischi freno appropriati per circa il 70% di tutti i modelli di veicoli elettrici e ibridi.

Pastiglie freno per veicoli elettrici e ibridi

Tutte le pastiglie freno Hella Pagid per veicoli elettrici e ibridi soddisfano requisiti elevati in termini di performance, comfort e durata.

Anche la tutela dell'ambiente e l'ecosostenibilità svolgono già oggi un ruolo molto importante nello sviluppo dei prodotti. Particolarmente rilevante è soprattutto il contenuto di rame delle pastiglie freno. Hella Pagid si è posta l'obiettivo di trasformare a livello internazionale la propria gamma di pastiglie freno, proponendo pastiglie con una percentuale di rame di massimo lo 0,5% rispetto al peso totale.

Le pastiglie freno anteriori e posteriori di tutti i veicoli elettrici e ibridi soddisfano già oggi questi requisiti severi e sono contrassegnate con il relativo simbolo a più foglie (N – senza rame).

La formulazione priva di rame delle pastiglie freno non è stata realizzata unicamente nell'ottica di tutelare l'ambiente, ma anche studiata appositamente per ogni tipo di veicolo, sistema frenante, potenza del motore, condizioni di guida e tutte le caratteristiche di frenata.

I veicoli elettrici e ibridi hanno una cosa in comune: la particolare curva di coppia lineare consente di raggiungere velocità elevate in breve tempo, ed è per questo che sono necessarie prestazioni in frenata eccellenti.

A questo contribuisce la formulazione del materiale d'attrito. L'azienda ha testato il coefficiente d'attrito, la pressione sul pedale e la capacità di dissipare il carico termico di questo materiale nel proprio Centro di Ricerca e Sviluppo. Inoltre le pastiglie freno superano i requisiti della normativa ECE 90.

In questo opuscolo troverete un piccolo estratto della nostra vasta gamma di dischi e pastiglie freno per veicoli elettrici e ibridi.

DISCHI FRENO AD ALTO TENORE DI CARBONIO PER VEICOLI ELETTRICI E IBRIDI

In particolare per veicoli elettrici e ibridi con una potenza motore elevata, con caratteristiche di guida a livello di auto sportiva, ma che per il peso delle loro batterie, sono notevolmente più pesanti, Hella Pagid propone dischi freno ad alto tenore di carbonio con un'alta resistenza ai carichi. L'elevata percentuale di carbonio consente prestazioni di frenatura ottimali anche in situazioni estreme grazie a una dissipazione di calore veloce.



Fading minore

Prestazioni di frenatura ottimali anche in situazioni estreme grazie a una dissipazione di calore più veloce della ghisa grigia ad alta resistenza.

Riduzione della rumorosità

Massime proprietà insonorizzanti grazie all'alto tenore di carbonio.

Minore ovalizzazione dei dischi

Minore deformazione dovuta alla migliore conducibilità termica del materiale ad alto tenore di carbonio.

Il risultato: meno vibrazioni. Assenza di rumorosità.

Protezione sicura

La verniciatura protegge la campana e l'anello esterno dalla corrosione in modo permanente e presenta inoltre maggiore resistenza ai pulitori per cerchi.

Standard OE

Il materiale High Carbon corrisponde alla qualità OE.

Maggiore comfort di frenata

Grazie a ottimi valori di tolleranza la frenata diventa più sicura e diretta.

Montaggio veloce

Il rivestimento rende superfluo l'uso di un olio protettivo. Quindi il disco freno è subito pronto per il montaggio.

Rivestimento ecosostenibile

Il rivestimento consiste in una vernice speciale a base d'acqua assolutamente sicura per l'ambiente.

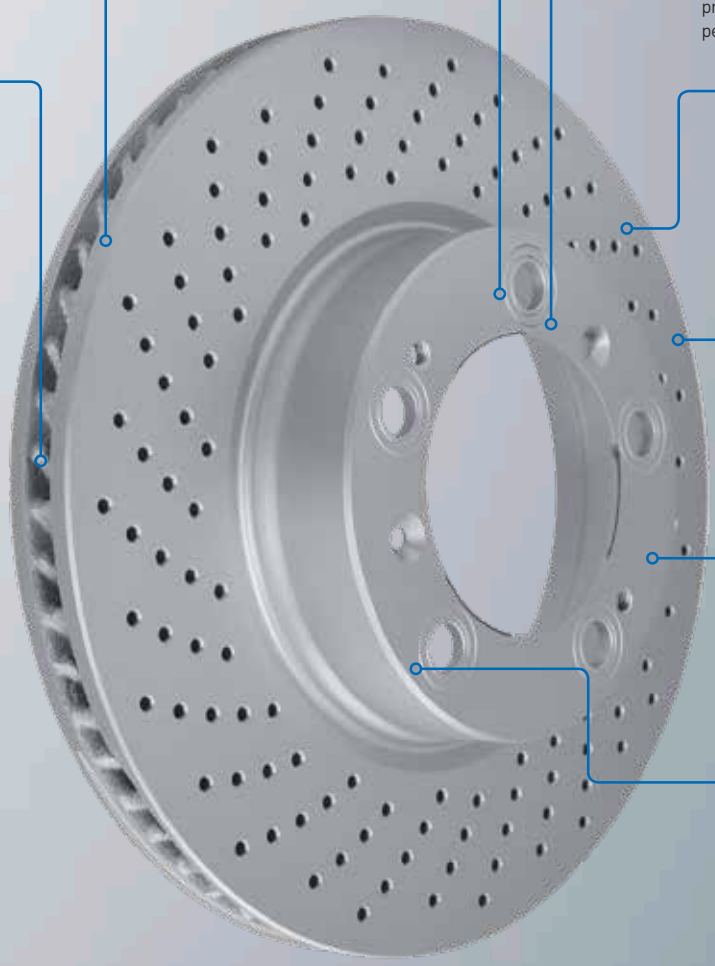

SEMPLIFICAZIONE DELLA PROCEDURA DI IDENTIFICAZIONE DEL PRODOTTO

Ulteriori informazioni sui nostri prodotti: con l'aiuto del nostro catalogo ricambi online "BrakeGuide" e della nostra app mobile avete la possibilità di accedere in qualsiasi momento alla nostra gamma completa dal vostro PC, smartphone o tablet e di identificare il prodotto adatto per il vostro veicolo.



Catalogo ricambi online

La BrakeGuide si basa su dati TecDoc aggiornati settimanalmente e offre alle officine la possibilità di un'identificazione intuitiva e mirata dei componenti dei freni della gamma Hella Pagid. I clienti possono inoltre realizzare i propri cataloghi personalizzati nel formato tipico di Hella Pagid. www.brakeguide.com



App BrakeGuide

L'app del catalogo di Hella Pagid Brake Systems facilita l'identificazione dei ricambi e semplifica i processi in officina e di distribuzione. Disponibile per iOS e Android!

ESEMPI DALLA GAMMA

BMW

PRODUTTORE	MODELLO	TIPO DI VEICOLO	ANNO	ARTICOLO	CODICE ARTICOLO	CODICE OE
BMW	i3 (I01)	Electric Range Extender s Electric s Range Extender	a partire da 08.13 a partire da 11.17		8DB 355 021-881	34106884267; 34116862309
					8DB 355 026-661	34216859917; 34216860403
					8DB 355 021-681	34216859917; 34216860403
					8DD 355 122-661	34216799367

Fiat



PRODUTTORE	MODELLO	TIPO DI VEICOLO	ANNO	ARTICOLO	CODICE ARTICOLO	CODICE OE
Fiat	500 (312_)	Electric	a partire da 09.12		8DB 355 023-271	K68088919AB
					8DB 355 021-751	68102483AA; 68102483AB; K68102483AA; K68102483AB

Honda

PRODUTTORE	MODELLO	TIPO DI VEICOLO	ANNO	ARTICOLO	CODICE ARTICOLO	CODICE OE
Honda	Insight (ZE_)	1.3 Hybrid (ZE2) 1.5 Hybrid (ZE3)	a partire da 04.09 a partire da 10.11		8DB 355 016-451	06430S0AJ00; 06430S2A000; 06430S2AE50; 06430S5AJ00; 06430S6DE50; 06430S84A00; 43022S0A000; 43022S5AE50; 43022S5AJ00; 43022S5AJ01; 43022S6D000; 43022S6DE50; 43022S84A50; 43022SED000; 43022SEDE50; 43022SEPC01; 43022SG0000; 43022SG0010; 43022SG0020; 43022SG0G00; 43022SG0G01; 43022SG0G02; 43022SG0G03; 43022SL5000; 43022SL5505; 43022SL5525; 43022SM4505; 43022SM4515; 43022SM4525; 43022SM4950; 43022SM4G00; 43022SM5A00; 43022SN7000; 43022SN7E50; 43022SN7E50HE; 43022SP0000; 43022SP0020; 43022SP0030; 43022SP0E00; 43022SP0E01; 43022SP0E02; 43022SP0E03; 43022SV4000; 43022SV4010; 43022SV4020; 43022SV4030; 43022SV4A00; 43022SV4A01; 43022SV4A02; 43022SV4A03; 43022SV4A21; 43022SV4E50; 43022SV4G00; 43022SV4G01; 43022SV4G02; 43022SV4G20; 43022SV4G21; 43022SV4G22; 43022SV4G23; 43022SY8A00; 43022SY8A01; 43022SY8A02; 43022SY8E50; 43022SZTG01; 43022TDJ000; 43022TF2G00; 43022TM8G00; 43022TM8G01; 43022TR0A00; 43022TR0A01; 43022TR0E00; 45022SN7000; 5580057L00; 5580057L00000; 5580057L50; 5580057L50000; 5580057L51; 5580080J00; 5580080J01; 5580080J04; 5580080J10; 586000975; 5860009750; 586011847; 5860118470; 586012604; 586014313; 5860143130; 586014813; 5860148130; 586015195; 5860151950; 5860197370; AY060HN003; GBP90331; GBP90331AF; GBP90339; GBP90339AF; H4302S5A003; H4302SM4003; H4302SV4003; SFP000080; SFP100220EVA
					8DB 355 028-801	45022SNCE00; 45022SZTG00; 45022SZTJ00; 45022T5BJ00; 45022T5BJ10; 45022T5CJ00; 45022T9AT00; 45022TARG00; 45022TF0G00; 45022TF0G01; 45022TF0G02; 45022TF2J00; 45022TF2J01; 45022TK6A00; 45022TK6A01; 45022TM0T00; 45022TM8G00; H4502TM8003

ESEMPI DALLA GAMMA

Honda

PRODUTTORE	MODELLO	TIPO DI VEICOLO	ANNO	ARTICOLO	CODICE ARTICOLO	CODICE OE
					8DB 355 027-801	06430S0AJ00; 06430S2A000; 06430S2AE50; 06430S5AJ00; 06430S6DE50; 06430S84A00; 43022S0A000; 43022S5AE50; 43022S5AJ00; 43022S5AJ01; 43022S6D000; 43022S6DE50; 43022S84A50; 43022SE000; 43022SEDE50; 43022SEPC01; 43022S60000; 43022S60010; 43022S60020; 43022S60G00; 43022S60G01; 43022S60G02; 43022S60G03; 43022SL5000; 43022SL5505; 43022SL5525; 43022SM4505; 43022SM4515; 43022SM4525; 43022SM4950; 43022SM4G00; 43022SM5A00; 43022SN7000; 43022SN7E50; 43022SN7E50HE; 43022SP0000; 43022SP0020; 43022SP0030; 43022SP0E00; 43022SP0E01; 43022SP0E02; 43022SP0E03; 43022SV4000; 43022SV4010; 43022SV4020; 43022SV4030; 43022SV4A00; 43022SV4A01; 43022SV4A02; 43022SV4A03; 43022SV4A21; 43022SV4E50; 43022SV4G00; 43022SV4G01; 43022SV4G02; 43022SV4G20; 43022SV4G21; 43022SV4G22; 43022SV4G23; 43022SY8A00; 43022SY8A01; 43022SY8A02; 43022SY8E50; 43022SZTG01; 43022TDJ000; 43022TF2G00; 43022TM8G00; 43022TM8G01; 43022TR0A00; 43022TR0A01; 43022TR0E00; 45022SN7000; 5580057L000; 5580057L00000; 5580057L50; 5580057L50000; 5580057L51; 5580080J00; 5580080J01; 5580080J04; 5580080J10; 586000975; 5860009750; 586011847; 5860118470; 586012604; 586014313; 5860143130; 586014813; 5860148130; 586015195; 5860151950; 5860197370; AY060HN003; GBP90331; GBP90331AF; GBP90339; GBP90339AF; H4302S5A003; H4302SM4003; H4302SV4003; SFP000080; SFP100220EVA
					8DB 355 015-001	45022SNCE00; 45022SZTG00; 45022SZTJ00; 45022T5BJ00; 45022T5BJ10; 45022T5CJ00; 45022T9AT00; 45022TARG00; 45022TF0G00; 45022TF0G01; 45022TF0G02; 45022TF2J00; 45022TF2J01; 45022TK6A00; 45022TK6A01; 45022TM0T00; 45022TM8G00; H4502TM8003
					8DD 355 103-121	45251S5DA10; 45251S5HT10; 45251S6DE10; 45251SCC000; 45251SCC900; 45251SK7000; 45251SK7A00; 45251SK7A10; 45251SK7J00; 45251SR0A00; 45251SR0A10; 45251ST3E10; 45251TF3E00; 45251TF3E01; 45251TG5H00; GBD90840; SDB000990; SDB000991; SDB100600
					8DD 355 122-531	42510TM8G00
Honda	Insight (ZE_)	1.3 Hybrid (ZE28, ZE2)	a partire da 04.09		8DB 355 016-451	06430S0AJ00; 06430S2A000; 06430S2AE50; 06430S5AJ00; 06430S6DE50; 06430S84A00; 43022S0A000; 43022S5AE50; 43022S5AJ00; 43022S5AJ01; 43022S6D000; 43022S6DE50; 43022S84A50; 43022SE000; 43022SEDE50; 43022SEPC01; 43022S60000; 43022S60010; 43022S60020; 43022S60G00; 43022S60G01; 43022S60G02; 43022S60G03; 43022SL5000; 43022SL5505; 43022SL5525; 43022SM4505; 43022SM4515; 43022SM4525; 43022SM4950; 43022SM4G00; 43022SM5A00; 43022SN7000; 43022SN7E50; 43022SN7E50HE; 43022SP0000; 43022SP0020; 43022SP0030; 43022SP0E00; 43022SP0E01; 43022SP0E02; 43022SP0E03; 43022SV4000; 43022SV4010; 43022SV4020; 43022SV4030; 43022SV4A00; 43022SV4A01; 43022SV4A02; 43022SV4A03; 43022SV4A21; 43022SV4E50; 43022SV4G00; 43022SV4G01; 43022SV4G02; 43022SV4G20; 43022SV4G21; 43022SV4G22; 43022SV4G23; 43022SY8A00; 43022SY8A01; 43022SY8A02; 43022SY8E50; 43022SZTG01; 43022TDJ000; 43022TF2G00; 43022TM8G00; 43022TM8G01; 43022TR0A00; 43022TR0A01; 43022TR0E00; 45022SN7000; 5580057L000; 5580057L00000; 5580057L50; 5580057L50000; 5580057L51; 5580080J00; 5580080J01; 5580080J04; 5580080J10; 586000975; 5860009750; 586011847; 5860118470; 586012604; 586014313; 5860143130; 586014813; 5860148130; 586015195; 5860151950; 5860197370; AY060HN003; GBP90331; GBP90331AF; GBP90339; GBP90339AF; H4302S5A003; H4302SM4003; H4302SV4003; SFP000080; SFP100220EVA
					8DB 355 028-801	45022SNCE00; 45022SZTG00; 45022SZTJ00; 45022T5BJ00; 45022T5BJ10; 45022T5CJ00; 45022T9AT00; 45022TARG00; 45022TF0G00; 45022TF0G01; 45022TF0G02; 45022TF2J00; 45022TF2J01; 45022TK6A00; 45022TK6A01; 45022TM0T00; 45022TM8G00; H4502TM8003
					8DB 355 027-801	06430S0AJ00; 06430S2A000; 06430S2AE50; 06430S5AJ00; 06430S6DE50; 06430S84A00; 43022S0A000; 43022S5AE50; 43022S5AJ00; 43022S5AJ01; 43022S6D000; 43022S6DE50; 43022S84A50; 43022SE000; 43022SEDE50; 43022SEPC01; 43022S60000; 43022S60010; 43022S60020; 43022S60G00; 43022S60G01; 43022S60G02; 43022S60G03; 43022SL5000; 43022SL5505; 43022SL5525; 43022SM4505; 43022SM4515; 43022SM4525; 43022SM4950; 43022SM4G00; 43022SM5A00; 43022SN7000; 43022SN7E50; 43022SN7E50HE; 43022SP0000; 43022SP0020; 43022SP0030; 43022SP0E00; 43022SP0E01; 43022SP0E02; 43022SP0E03; 43022SV4000; 43022SV4010; 43022SV4020; 43022SV4030; 43022SV4A00; 43022SV4A01; 43022SV4A02; 43022SV4A03; 43022SV4A21; 43022SV4E50; 43022SV4G00; 43022SV4G01; 43022SV4G02; 43022SV4G20; 43022SV4G21; 43022SV4G22; 43022SV4G23; 43022SY8A00; 43022SY8A01; 43022SY8A02; 43022SY8E50; 43022SZTG01; 43022TDJ000; 43022TF2G00; 43022TM8G00; 43022TM8G01; 43022TR0A00; 43022TR0A01; 43022TR0E00; 45022SN7000; 5580057L000; 5580057L00000; 5580057L50; 5580057L50000; 5580057L51; 5580080J00; 5580080J01; 5580080J04; 5580080J10; 586000975; 5860009750; 586011847; 5860118470; 586012604; 586014313; 5860143130; 586014813; 5860148130; 586015195; 5860151950; 5860197370; AY060HN003; GBP90331; GBP90331AF; GBP90339; GBP90339AF; H4302S5A003; H4302SM4003; H4302SV4003; SFP000080; SFP100220EVA



Set pastiglie freno





Disco freno





HELLA PAGID
BRAKE SYSTEMS

Honda



PRODUTTORE	MODELLO	TIPO DI VEICOLO	ANNO	ARTICOLO	CODICE ARTICOLO	CODICE OE
					8DB 355 015-001	45022SNCE00; 45022SZTG00; 45022SZTJ00; 45022T5BJ00; 45022T5BJ10; 45022T5CJ00; 45022T9AT00; 45022TARG00; 45022TF0G00; 45022TF0G01; 45022TF0G02; 45022TF2J00; 45022TF2J01; 45022TK6A00; 45022TK6A01; 45022TM0T00; 45022TM8G00; H4502TM8003
					8DB 355 027-201	06450S5AE50; 06450S5AG00; 06450S5AJ00; 06450S5BJ00; 06450S7AJ00; 45022S04V10; 45022S04V00; 45022S04V01; 45022S04V02; 45022S04V11; 45022S04V12; 45022S5AE50; 45022S5AG00; 45022S5AG01; 45022S5AJ00; 45022S5BJ00; 45022S5BJ01; 45022S7A000; 45022S7A010; 45022SCC000; 45022S04V10; 45022S04V11; 45022S04V12; 45022SR3V00; 45022SR3V01; 45022SR3V02; 45022SR3V03; 45022SR3V10; 45022SR3V11; 45022SR3V12; 45022TG0T00; 45022TR2A00; 45022TR2A01; 586005260; 5860052600; 586005261; 5860052610; 586009207; 5860092070; 586014123; 5860141230; 586014456; 5860144560; 586014834; 5860148340; AY040HN007; H4502S04003; H4502S7A003; H4502SCC003
					8DB 355 016-461	06450S5AE50; 06450S5AG00; 06450S5AJ00; 06450S5BJ00; 06450S7AJ00; 45022S04V10; 45022S04V00; 45022S04V01; 45022S04V02; 45022S04V11; 45022S04V12; 45022S5AE50; 45022S5AG00; 45022S5AG01; 45022S5AJ00; 45022S5BJ00; 45022S5BJ01; 45022S7A000; 45022S7A010; 45022SCC000; 45022S04V10; 45022S04V11; 45022S04V12; 45022SR3V00; 45022SR3V01; 45022SR3V02; 45022SR3V03; 45022SR3V10; 45022SR3V11; 45022SR3V12; 45022TG0T00; 45022TR2A00; 45022TR2A01; 586005260; 5860052600; 586005261; 5860052610; 586009207; 5860092070; 586014123; 5860141230; 586014456; 5860144560; 586014834; 5860148340; AY040HN007; H4502S04003; H4502S7A003; H4502SCC003
					8DD 355 103-121	45251S5DA10; 45251S5HT10; 45251S6DE10; 45251SCC000; 45251SCC900; 45251SK7000; 45251SK7A00; 45251SK7A10; 45251SK7J00; 45251SR0A00; 45251SR0A10; 45251ST3E10; 45251TF3E00; 45251TF3E01; 45251TG5H00; GBD90840; SDB000990; SDB000991; SDB100600
					8DD 355 122-531	42510TM8G00
Honda	Jazz IV (GK_)	1.5 Hybrid 1.5 Hybrid 4WD	a partire da 09.13		8DB 355 027-801	06430S0AJ00; 06430S2A000; 06430S2AE50; 06430S5AJ00; 06430S6DE50; 06430S84A00; 43022S0A000; 43022S5AE50; 43022S5AJ00; 43022S5AJ01; 43022S6D000; 43022S6DE50; 43022S84A50; 43022SEDE000; 43022SEDE50; 43022SEPC01; 43022SG0000; 43022SG0010; 43022SG0020; 43022SG0G00; 43022SG0G01; 43022SG0G02; 43022SG0G03; 43022SL5000; 43022SL5505; 43022SL5525; 43022SM4505; 43022SM4515; 43022SM4525; 43022SM4950; 43022SM4G00; 43022SM5A00; 43022SN7000; 43022SN7E50; 43022SN7E50HE; 43022SP0000; 43022SP0020; 43022SP0030; 43022SP0E00; 43022SP0E01; 43022SP0E02; 43022SP0E03; 43022SV4000; 43022SV4010; 43022SV4020; 43022SV4030; 43022SV4A00; 43022SV4A01; 43022SV4A02; 43022SV4A03; 43022SV4A21; 43022SV4E50; 43022SV4G00; 43022SV4G01; 43022SV4G02; 43022SV4G20; 43022SV4G21; 43022SV4G22; 43022SV4G23; 43022SY8A00; 43022SY8A01; 43022SY8A02; 43022SY8E50; 43022SZTG01; 43022TDJ000; 43022TF2G00; 43022TM8G00; 43022TM8G01; 43022TROA00; 43022TROA01; 43022TROE00; 45022SN7000; 5580057L00; 5580057L00000; 5580057L50; 5580057L50000; 5580057L51; 5580080J00; 5580080J01; 5580080J04; 5580080J10; 586000975; 5860009750; 586011847; 5860118470; 586012604; 586014313; 5860143130; 586014813; 5860148130; 586015195; 5860151950; 5860197370; AY060HN003; GBP90331; GBP90331AF; GBP90339; GBP90339AF; H4302S5A003; H4302SM4003; H4302SV4003; SFP000080; SFP100220EVA
					8DB 355 015-001	45022SNCE00; 45022SZTG00; 45022SZTJ00; 45022T5BJ00; 45022T5BJ10; 45022T5CJ00; 45022T9AT00; 45022TARG00; 45022TF0G00; 45022TF0G01; 45022TF0G02; 45022TF2J00; 45022TF2J01; 45022TK6A00; 45022TK6A01; 45022TM0T00; 45022TM8G00; H4502TM8003

ESEMPI DALLA GAMMA

Honda

PRODUTTORE	MODELLO	TIPO DI VEICOLO	ANNO	ARTICOLO	CODICE ARTICOLO	CODICE OE
					8DB 355 016-451	06430S0AJ00; 06430S2A000; 06430S2AE50; 06430S5AJ00; 06430S6DE50; 06430S84A00; 43022S0A000; 43022S5AE50; 43022S5AJ00; 43022S5AJ01; 43022S6D000; 43022S6DE50; 43022S84A50; 43022SEDD00; 43022SEDE50; 43022SEPC01; 43022SG0000; 43022SG0010; 43022SG0020; 43022SG0G00; 43022SG0G01; 43022SG0G02; 43022SG0G03; 43022SL5000; 43022SL5505; 43022SL5525; 43022SM4505; 43022SM4515; 43022SM4525; 43022SM4950; 43022SM4G00; 43022SM45A00; 43022SN7000; 43022SN7E50; 43022SN7E50HE; 43022SP0000; 43022SP0020; 43022SP0030; 43022SP0E00; 43022SP0E01; 43022SP0E02; 43022SP0E03; 43022SV4000; 43022SV4010; 43022SV4020; 43022SV4030; 43022SV4A00; 43022SV4A01; 43022SV4A02; 43022SV4A03; 43022SV4A21; 43022SV4E50; 43022SV4G00; 43022SV4G01; 43022SV4G02; 43022SV4G20; 43022SV4G21; 43022SV4G22; 43022SV4G23; 43022SY8A00; 43022SY8A01; 43022SY8A02; 43022SY8E50; 43022SZTG01; 43022TDJ00; 43022TF2G00; 43022TM8G00; 43022TM8G01; 43022TR0A00; 43022TR0A01; 43022TR0E00; 45022SN7000; 5580057L00; 5580057L00000; 5580057L50; 5580057L50000; 5580057L51; 5580080J00; 5580080J01; 5580080J04; 5580080J10; 586000975; 5860009750; 586011847; 5860118470; 586012604; 586014313; 5860143130; 586014813; 5860148130; 586015195; 5860151950; 5860197370; AY060HN003; GBP90331; GBP90331AF; GBP90339; GBP90339AF; H4302S5A003; H4302SM4003; H4302SV4003; SFP000080; SFP100220EVA
					8DB 355 028-801	45022SNCE00; 45022SZTG00; 45022SZTJ00; 45022T5BJ00; 45022T5BJ10; 45022T5CJ00; 45022T9AT00; 45022TARG00; 45022TF0G00; 45022TF0G01; 45022TF0G02; 45022TF2J00; 45022TF2J01; 45022TK6A00; 45022TK6A01; 45022TM0T00; 45022TM8G00; H4502TM8003
					8DD 355 122-531	42510TM8G00
					8DD 355 103-121	45251S5DA10; 45251S5HT10; 45251S6DE10; 45251SCC000; 45251SCC900; 45251SK7000; 45251SK7A00; 45251SK7A10; 45251SK7J00; 45251SR0A00; 45251SR0A10; 45251ST3E10; 45251TF3E00; 45251TF3E01; 45251TG5H00; GBD90840; SDB000990; SDB000991; SDB100600

Kia

PRODUTTORE	MODELLO	TIPO DI VEICOLO	ANNO	ARTICOLO	CODICE ARTICOLO	CODICE OE
Kia	Soul II (PS)	EV Electric	a partire da 09.14		8DB 355 030-311	
					8DB 355 028-871	48413350B0; 583021RA30; 583021WA30; 583021WA35; 583023KA35; 583023RA70; 583023XA30; 583023ZA00; 583023ZA10; 583023ZA16; 583023ZA70; 583023ZA76; 58302A4B10; 58302A5A20; 58302A5B30; 58302A6A20; 58302B2A00; 58302B2A70; 58302C1A50; 58302C8A30; 58302D4A55; 58302D4A65; 58302D7A70; 58302E4A10; 58302G2A40
					8DB 355 015-841	581012SA51; 581012SA70; 581012SA75; 581012YA00; 581012YA50; 581013RA05; 581013RA60; 581013ZA10; 581013ZA16; 581013ZA70; 581013ZA76; 581014WA10; 58101A2A35; 58101B2A60; 58101B2A80; 58101B2A90; 58101D4A15; 58101D4A25; 58101D7A50; 58101E4A10
					8DB 355 019-981	48413350B0; 583021RA30; 583021WA30; 583021WA35; 583023KA35; 583023RA70; 583023XA30; 583023ZA00; 583023ZA10; 583023ZA16; 583023ZA70; 583023ZA76; 58302A4B10; 58302A5A20; 58302A5B30; 58302A6A20; 58302B2A00; 58302B2A70; 58302C1A50; 58302C8A30; 58302D4A55; 58302D4A65; 58302D7A70; 58302E4A10; 58302G2A40
					8DB 355 021-991	581011MA00; 581011MA20; 581011MA21; 58101B2A00
					8DD 355 126-651	584113R700; 584113V500
					8DD 355 114-481	517122L500; 517123V000; 51712A6600
					8DD 355 129-451	584113X300; 58411A6300



Set pastiglie freno







Disco freno





BRAKE SYSTEMS

Lexus





PRODUTTORE	MODELLO	TIPO DI VEICOLO	ANNO	ARTICOLO	CODICE ARTICOLO	CODICE OE				
Lexus	CT (ZWA10_)	200h (ZWA10_)	a partire da 12.10 a partire da 09.11		8DB 355 014-311	044650W140; 044650W141; 0446547060; 0446547070; 0446547080; 0446547090; 0446547100				
					8DB 355 028-551	044650W140; 044650W141; 0446547060; 0446547070; 0446547080; 0446547090; 0446547100				
					8DB 355 014-991	0446602210; 0446602310; 0446621020; 0446647020; 0446647030; 0446647060; 0446647061; 0446647080; 0446676010; 0446676011; 0446676012; 446647030				
					8DD 355 116-981	4351247040; 4351247050				
					8DD 355 120-191	4243152160				
					8DD 355 116-901	4243102250; 4243112310				
				Lexus	ES (_V6_)	300h (ASV60_, AVV60_)	06.12 - 06.18		8DB 355 012-401	0446506070; 0446506080; 0446506100; 0446506110; 0446506131; 0446507010; 0446533440; 0446533450; 0446533470; 0446533471; 04465YZZEG
									8DB 355 028-471	0446506070; 0446506080; 0446506100; 0446506110; 0446506131; 0446507010; 0446533440; 0446533450; 0446533470; 0446533471; 04465YZZEG
									8DB 355 006-881	0446602220; 0446606060; 0446606070; 0446606090; 0446606100; 0446606200; 0446633160; 0446633180; 0446633200; 0446633210; 0446642060; 044664206079; 0446675010; 04466WY050; 04466YZZE8; 19184917
	8DB 355 028-441	0446602220; 0446606060; 0446606070; 0446606090; 0446606100; 0446606200; 0446633160; 0446633180; 0446633200; 0446633210; 0446642060; 044664206079; 0446675010; 04466WY050; 04466YZZE8; 19184917								
	8DD 355 118-561	4351202250; 4351206090; 4351206100; 4351206120; 4351206140; 435122090; 4351233130; 4351233140; 4351242050; 4351242090; 4351242100								
	8DD 355 117-431	4351206090; 4351206100; 4351206140; 4351233130; 4351233140								

Mercedes-Benz



PRODUTTORE	MODELLO	TIPO DI VEICOLO	ANNO	ARTICOLO	CODICE ARTICOLO	CODICE OE
Mercedes-Benz	B-CLASS (W246, W242)	Electric Drive / B 250 e (242.890)	11.14 - 10.17		8DB 355 019-721	0064204620; 0064204720; 0064208520; 0084200320; 0084200620; 410605DA0A; 410605DA0B; A0064204620; A0064204720; A0064208520; A0084200320; A0084200620
					8DB 355 021-791	0064208120; 0074209620; 440605DA0A; 44060HG00A; A0064208120; A0074209620
					8DB 355 026-471	0064204620; 0064204720; 0064208520; 0084200320; 0084200620; 410605DA0A; 410605DA0B; A0064204620; A0064204720; A0064208520; A0084200320; A0084200620
					8DD 355 119-421	2464230112; A2464230112
					8DD 355 129-681	2464212512; A2464212512
					8DD 355 119-422	2464230112; A2464230112
				8DD 355 119-411	2464212412; A2464212412	

ESEMPI DALLA GAMMA



Nissan

PRODUTTORE	MODELLO	TIPO DI VEICOLO	ANNO	ARTICOLO	CODICE ARTICOLO	CODICE OE
Nissan	Leaf (ZE1_)	Electric	a partire da 11.10		8DB 355 023-321	D10603TA0A; D10603TS0A
					8DB 355 020-401	040604BA0B; 5518050Z10; 5580077K02; 5580077K03; 5580077K04; 5581050Z30; 5581051Z10; 5581051Z30; AY060NS048; AY060NS053; AY060NS055; AY060NS057; AY060NS059; AY060NS060; AY060NS53; AY060NS907; D40601BNOA; D40601GZ0C; D40601MB0A; D40603NK0A; D40604CU2A; D40609HM0B; D4M601BNOA; D4M601BNOA; D4M609N00B; D4M60EG50C; MQ706234
					8DB 355 016-121	41060ZP00A; D10601VA8E; D10603LM0A; D1060EB70A; D1060JR70A; D1060ZP00A; D1060ZP00C; D1M60CY70B
					8DB 355 030-671	D10603TA0A; D10603TS0A
				8DB 355 028-021	040604BA0B; 5518050Z10; 5580077K02; 5580077K03; 5580077K04; 5581050Z30; 5581051Z10; 5581051Z30; AY060NS048; AY060NS053; AY060NS055; AY060NS057; AY060NS059; AY060NS060; AY060NS53; AY060NS907; D40601BNOA; D40601GZ0C; D40601MB0A; D40603NK0A; D40604CU2A; D40609HM0B; D4M601BNOA; D4M601BNOA; D4M609N00B; D4M60EG50C; MQ706234	
					8DD 355 125-071	402063NA0A; 402063NL0A; 402063NL0B
					8DD 355 122-791	402064BA0A; 402064EA0A; 402064EA0B; 402066624R
					8DD 355 118-711	432000016R; 432003112R; 432063NL0A; 432068H304; 432068H305; 432068H700; 432068H701; 432068H702
8DB 355 021-491	440603981R; 440606633R; D40604CA0A; D40604EA0A; D40604EA0B; D40605SA0A					
	Nissan	Leaf (ZE1_)	Electric	a partire da 08.17 a partire da 01.19	8DB 355 021-491	440603981R; 440606633R; D40604CA0A; D40604EA0A; D40604EA0B; D40605SA0A
						8DD 355 123-061
					8DD 355 125-071	402063NA0A; 402063NL0A; 402063NL0B

Renault

PRODUTTORE	MODELLO	TIPO DI VEICOLO	ANNO	ARTICOLO	CODICE ARTICOLO	CODICE OE
Renault	ZOE (BFM_)	R110 ZOE ZOE R75	a partire da 05.18 a partire da 06.12 a partire da 12.17		8DB 355 010-851	4106000Q0K; 410604076R; 410604775R; 410608481R; 41060AX601; 41060AX625; 41060AZ625; 4154210510; 7701208422; 7701209164; A4154210510; D1060AX60A; D1060AX61A; D1060AX61F; D1060BH40A
						8DD 355 118-491

Smart

PRODUTTORE	MODELLO	TIPO DI VEICOLO	ANNO	ARTICOLO	CODICE ARTICOLO	CODICE OE
Smart	ForTwo Coupé (451)	electric drive electric drive (451.390, 451.391) electric drive (451.390)	09.10 - 12.12 a partire da 11.13		8DB 355 008-721	0001431V002000000; 0001431V003000000; 0001431V004000000; 4514210010; 4514210110; 4514210210; A4514210010; A4514210110; C0001431V002; C0001431V002000000; Q0001431V004000000
						8DD 355 113-561
					8DD 355 113-562	4514210112
		electric drive (451.391) electric drive Brabus (451.392)	12.11 - 12.12 12.10 - 12.12 11.09 - 12.11 a partire da 01.13 -			



Set pastiglie freno









Disco freno

Tesla



PRODUTTORE	MODELLO	TIPO DI VEICOLO	ANNO	ARTICOLO	CODICE ARTICOLO	CODICE OE
Tesla	Model S (5YJS)	100D AWD	a partire da 06.17		8DB 355 014-451	105506600B; 22866931; 89047725; DR332001CC; DR3Z2001C
		60	a partire da 11.13		8DB 355 005-301	420698451A; 420698451D; 4G432C562BA; 4S0698451C; AD432B926BA; C2C13800
		60D AWD	a partire da 10.14		8DB 355 021-251	105506800B; 583022MA10; 68144432AA
		70	a partire da 09.15			
		70D AWD	a partire da 04.15			
		75	a partire da 11.16			
		75D AWD	a partire da 06.16			
		85	09.12 - 02.16			
		85D AWD	10.14 - 02.16			
		90D AWD	10.14 - 02.16			
		P100D AWD	a partire da 09.15			
		P85	a partire da 10.16			
P85D AWD	05.13 - 12.14					
P90D AWD	10.14 - 02.16					
		a partire da 09.15				

Toyota

PRODUTTORE	MODELLO	TIPO DI VEICOLO	ANNO	ARTICOLO	CODICE ARTICOLO	CODICE OE					
Toyota	Prius (_W3_)	1.8 Hybrid (ZVW3_) 1.8 Plug-in Hybrid (ZVW35)	a partire da 06.08 a partire da 01.12		8DB 355 014-311	044650W140; 044650W141; 0446547060; 0446547070; 0446547080; 0446547090; 0446547100					
					8DB 355 013-581	0446602190; 0446602191; 0446602260; 0446602270; 0446602310; 0446647100; 0446647110; 0446652070; 0446652110; 0446652120; 0446652121; 0446652130; 0446652140; 0446652141; 0446652150; 0446652151; 0446652160; 0446652170; 04466WY010; 19184919; 19205534					
					8DB 355 028-551	044650W140; 044650W141; 0446547060; 0446547070; 0446547080; 0446547090; 0446547100					
					8DB 355 014-991	0446602210; 0446602310; 0446621020; 0446647020; 0446647030; 0446647060; 0446647061; 0446647080; 0446676010; 0446676011; 0446676012; 446647030					
					8DB 355 028-661	0446602190; 0446602191; 0446602260; 0446602270; 0446602310; 0446612130; 0446612140; 0446612150; 044662310; 0446647100; 0446647110; 0446652070; 0446652110; 0446652120; 0446652121; 0446652130; 0446652140; 0446652141; 0446652150; 0446652151; 0446652160; 0446652170; 04466WY010; 19184919; 19205534					
						8DD 355 116-981	4351247040; 4351247050				
						8DD 355 116-901	4243102250; 4243112310				
					Toyota	Prius C (NHP10_)	1.5 Hybrid 1.5 Hybrid (NHP10)	a partire da 09.11 a partire da 12.11		8DB 355 028-541	0446512640; 0446552180; 0446552200; 0446552320; 0446562260; 0446574040; 04465B1350
										8DB 355 016-191	0446512640; 0446552180; 0446552200; 0446552320; 0446562260; 0446574040; 04465B1350
										8DB 355 014-311	044650W140; 044650W141; 0446547060; 0446547070; 0446547080; 0446547090; 0446547100
8DB 355 028-551	044650W140; 044650W141; 0446547060; 0446547070; 0446547080; 0446547090; 0446547100										
	8DD 355 113-581	435120D090; 4351252120									
Toyota	Prius Plus (_W4_)	1.8 Hybrid (ZVW40W, ZVW41W)	a partire da 05.11							8DB 355 015-371	044660E010; 0446647051; 0446647070; 0446647071; 0446648130; 044664813079; 0446648140; 0446652180
					8DB 355 028-431	0446502230; 0446542140; 0446542150; 0446542180; 0446542190; 04465YZZDY; 19184911					
					8DB 355 006-871	0446502230; 0446542140; 0446542150; 0446542180; 0446542190; 04465YZZDY; 19184911					
						8DD 355 118-561	4351202250; 4351206090; 4351206100; 4351206120; 4351206140; 435122090; 4351233130; 4351233140; 4351242050; 4351242090; 4351242100				

ESEMPI DALLA GAMMA

Toyota

PRODUTTORE	MODELLO	TIPO DI VEICOLO	ANNO	ARTICOLO	CODICE ARTICOLO	CODICE OE
Toyota	Prius Hatchback (W2_)	1.5 Hybrid (NHW20_)	09.03 - 12.09		8DB 355 017-081	044650W050; 0446512580; 0446512590; 0446512591; 0446512592; 0446513020; 0446513040; 0446513041; 0446513050; 0446517100; 0446517101; 0446517140; 0446520480; 044652220; 0446532210; 0446547030; 0446547050; 0446552010; 0446552011; 0446552021; 0446552022; 0446552060; 0446552100; 0446552110; 0446552120; 0446552150; 0446552290; 04465YZZDA
					8DB 355 010-001	0446632030; 0446632040; 0446647010
					8DB 355 027-731	0446632030; 0446632040; 0446647010
					8DB 355 027-621	0446620090; 0446652010; 0446652020; 0446652030; 0446652040; 0446652050; 0446652060; 0446652090; 04466YZZD5
					8DB 355 017-221	0446620090; 0446652010; 0446652020; 0446652030; 0446652040; 0446652050; 0446652060; 0446652090; 04466YZZD5
					8DB 355 010-901	044650D020; 044650D030; 044650W080; 0446512581; 0446517102; 0446532230
					8DB 355 027-591	044650W050; 0446512580; 0446512590; 0446512591; 0446512592; 0446513020; 0446513040; 0446513041; 0446513050; 0446517100; 0446517101; 0446517140; 0446520480; 044652220; 0446532210; 0446547030; 0446547050; 0446552010; 0446552011; 0446552021; 0446552022; 0446552060; 0446552100; 0446552110; 0446552120; 0446552150; 0446552290; 04465YZZDA
					8DB 355 030-241	044650D020; 044650D030; 044650W080; 0446512581; 0446517102; 0446532230
					8DD 355 115-691	4351247030
					8DD 355 114-891	4243120390; 4243120420; 4243132110; 4243132111; 4243147030
Toyota	Prius (W5_)	1.8 Hybrid (ZVW50_, ZVW51_) 1.8 Hybrid (ZVW50) 1.8 Hybrid E-Four 4WD (ZVW55_)	a partire da 09.15		8DB 355 013-581	0446602190; 0446602191; 0446602260; 0446602270; 0446602310; 0446612130; 0446612140; 0446612150; 044662310; 0446647100; 0446647110; 0446652070; 0446652110; 0446652120; 0446652121; 0446652130; 0446652140; 0446652141; 0446652150; 0446652151; 0446652160; 0446652170; 04466WY010; 19184919; 19205534
					8DB 355 028-661	0446602190; 0446602191; 0446602260; 0446602270; 0446602310; 0446612130; 0446612140; 0446612150; 044662310; 0446647100; 0446647110; 0446652070; 0446652110; 0446652120; 0446652121; 0446652130; 0446652140; 0446652141; 0446652150; 0446652151; 0446652160; 0446652170; 04466WY010; 19184919; 19205534
					8DB 355 014-311	044650W140; 044650W141; 0446547060; 0446547070; 0446547080; 0446547090; 0446547100
					8DB 355 028-551	044650W140; 044650W141; 0446547060; 0446547070; 0446547080; 0446547090; 0446547100
					8DD 355 116-901	4243102250; 4243112310
					Toyota	Yaris (P13_)
8DB 355 024-361						
8DB 355 025-321	044650D120					
8DB 355 013-461	044660D010; 044660D010000					
8DB 355 006-861	0446502220; 0446502240; 0446502310; 0446502400; 0446502410; 0446512610; 0446542160; 044654216079; 0446542200; 04465D8000; 04465YZZDR					
8DD 355 113-591	435120D100; 435120D190; 4351252130					
8DD 355 125-491	435120D210					
8DD 355 114-051	424310D060; 424310D060000					













Set pastiglie freno





Disco freno

Toyota

PRODUTTORE	MODELLO	TIPO DI VEICOLO	ANNO	ARTICOLO	CODICE ARTICOLO	CODICE OE				
Toyota	Camry Saloon (V4_)	2.4 Hybrid (AHV40_)	01.06 - 09.11		8DB 355 012-401	0446506070; 0446506080; 0446506100; 0446506110; 0446506131; 0446507010; 0446533440; 0446533450; 0446533470; 0446533471; 04465YZZEG				
					8DB 355 028-471	0446506070; 0446506080; 0446506100; 0446506110; 0446506131; 0446507010; 0446533440; 0446533450; 0446533470; 0446533471; 04465YZZEG				
					8DB 355 006-881	0446602220; 0446606060; 0446606070; 0446606090; 0446606100; 0446606200; 0446633160; 0446633180; 0446633200; 0446633210; 0446642060; 044664206079; 0446675010; 04466WY050; 04466YZZE8; 19184917				
					8DB 355 028-441	0446602220; 0446606060; 0446606070; 0446606090; 0446606100; 0446606200; 0446633160; 0446633180; 0446633200; 0446633210; 0446642060; 044664206079; 0446675010; 04466WY050; 04466YZZE8; 19184917				
					8DD 355 118-561	4351202250; 4351206090; 4351206100; 4351206120; 4351206140; 435122090; 4351233130; 4351233140; 4351242050; 4351242090; 4351242100				
					8DD 355 117-431	4351206090; 4351206100; 4351206140; 4351233130; 4351233140				
				Toyota	Camry Saloon (V5_)	2.5 Hybrid (AVV50_)	a partire da 09.11		8DB 355 006-881	0446602220; 0446606060; 0446606070; 0446606090; 0446606100; 0446606200; 0446633160; 0446633180; 0446633200; 0446633210; 0446642060; 044664206079; 0446675010; 04466WY050; 04466YZZE8; 19184917
									8DB 355 012-401	0446506070; 0446506080; 0446506100; 0446506110; 0446506131; 0446507010; 0446533440; 0446533450; 0446533470; 0446533471; 04465YZZEG
									8DB 355 028-441	0446602220; 0446606060; 0446606070; 0446606090; 0446606100; 0446606200; 0446633160; 0446633180; 0446633200; 0446633210; 0446642060; 044664206079; 0446675010; 04466WY050; 04466YZZE8; 19184917
	8DB 355 028-471	0446506070; 0446506080; 0446506100; 0446506110; 0446506131; 0446507010; 0446533440; 0446533450; 0446533470; 0446533471; 04465YZZEG								
	8DD 355 117-431	4351206090; 4351206100; 4351206140; 4351233130; 4351233140								
	8DD 355 118-561	4351202250; 4351206090; 4351206100; 4351206120; 4351206140; 435122090; 4351233130; 4351233140; 4351242050; 4351242090; 4351242100								
Toyota	Auris (E18_)	1.8 Hybrid (ZWE186_)	10.12 - 12.18						8DB 355 028-431	0446502230; 0446542140; 0446542150; 0446542180; 0446542190; 04465YZZDY; 19184911
									8DB 355 020-281	0446502390; 0446502391; 0446502430
									8DB 355 006-871	0446502230; 0446542140; 0446542150; 0446542180; 0446542190; 04465YZZDY; 19184911
					8DB 355 013-571	0446602170; 0446602180; 0446602181; 0446602182; 0446602280; 0446602290; 0446602291; 04466YZZE3				
					8DD 355 118-561	4351202250; 4351206090; 4351206100; 4351206120; 4351206140; 435122090; 4351233130; 4351233140; 4351242050; 4351242090; 4351242100				
					8DD 355 119-661	4351202330				
				8DD 355 118-971	4243102170; 4243102180; 4243112280					
				Toyota	C-HR (X1_)	1.8 Hybrid (ZYG10_)	a partire da 10.16		8DB 355 025-121	044660E060; 044660E070; 0446610010; 0446633220; 0446648160
									8DB 355 030-201	044650E010; 044650E040; 0446533490; 0446548150; 0446548160; 0446548170; 0446548180; 0446548190; 0446548210; 0446548220
8DB 355 015-461	044650E010; 044650E040; 0446533490; 0446548150; 0446548160; 0446548170; 0446548180; 0446548190; 0446548210; 0446548220									
Toyota	RAV 4 IV (A4_)	2.5 Hybrid (AVA42_ AVA44_)	a partire da 10.15		8DB 355 028-431	0446502230; 0446542140; 0446542150; 0446542180; 0446542190; 04465YZZDY; 19184911				
					8DB 355 006-871	0446502230; 0446542140; 0446542150; 0446542180; 0446542190; 04465YZZDY; 19184911				
					8DB 355 006-881	0446602220; 0446606060; 0446606070; 0446606090; 0446606100; 0446606200; 0446633160; 0446633180; 0446633200; 0446633210; 0446642060; 044664206079; 0446675010; 04466WY050; 04466YZZE8; 19184917				
		2.5 Hybrid 4WD (AVA44_)	a partire da 11.15	a partire da 10.15		8DB 355 028-441	0446602220; 0446606060; 0446606070; 0446606090; 0446606100; 0446606200; 0446633160; 0446633180; 0446633200; 0446633210; 0446642060; 044664206079; 0446675010; 04466WY050; 04466YZZE8; 19184917			
						8DD 355 120-051	4351248110			
						8DD 355 118-561	4351202250; 4351206090; 4351206100; 4351206120; 4351206140; 435122090; 4351233130; 4351233140; 4351242050; 4351242090; 4351242100			
		2.5 Hybrid 4WD (AVA44)	a partire da 11.15	a partire da 10.15		8DD 355 118-881	424310R020; 4243142060			
		Electric (QEA38)				a partire da 11.15	12.12 - 08.14		8DD 355 118-881	424310R020; 4243142060

ESEMPI DALLA GAMMA

Volkswagen

PRODUTTORE	MODELLO	TIPO DI VEICOLO	ANNO	ARTICOLO	CODICE ARTICOLO	CODICE OE	
Volkswagen	Golf VII (5G1, BQ1, BE1, BE2)	1.4 GTE Hybrid	a partire da 05.14		8DB 355 020-271	5Q0698451C; 5Q0698451N; 8V0698451; 8V0698451B; 8V0698451F	
					8DB 355 023-171	2K5698151; 2K5698151A; 2K5698151B; 2Q0698151F; 5Q0698151D; 5QD698151	
					8DB 355 015-921	3C0698151E; 3C0698151F; 3C0698151G; 3C0698151H; 5Q0698151G; 7N0698151A; 7N0698151B; 7N0698151C; 7N0698151D	
					8DB 355 021-971	8V0698151C	
					8DB 355 026-561	5Q0698451C; 5Q0698451N; 8V0698451; 8V0698451B; 8V0698451F	
					8DB 355 020-261	3Q0698451; 3Q0698451B; 3Q0698451C; 3Q0698451D; 3Q0698451E; 3QF698451; 5G0698451; 5Q0698451P; 8V0698451A; 8V0698451D	
					8DB 355 020-191	5Q0698151; 5Q0698151B; 8V0698151; 8V0698151A; 8V0698151B; 8V0698151D; 8V0698151G	
					8DB 355 021-951	5Q0698151C	
					8DB 355 026-541	5Q0698151; 5Q0698151B; 8V0698151; 8V0698151A; 8V0698151B; 8V0698151D; 8V0698151G	
						8DD 355 109-582	1K0615301K; 1K0615301T; 5C0615301A; 5Q0615301H; JZW615301J
						8DD 355 128-001	1K0615301K; 1K0615301T; 5C0615301A; 5Q0615301H; JZW615301J
						8DD 355 112-122	1K0615601N; 5Q0615601E; JZW698601AQ
						8DD 355 129-241	1K0615301AD; 3C0615301C; 5Q0615301G; 8S0615301
						8DD 355 109-581	1K0615301K; 1K0615301T; 5C0615301A; 5Q0615301H; JZW615301J
						8DD 355 122-592	1K0615301AA; 1K0615301D; 561615301; 561615301B; 5C0615301B; 5Q0615301F; JZW615301H
				8DD 355 116-971		1K0615601AA; 5Q0615601D	
				8DD 355 123-531		1K0615301K; 1K0615301T; 5C0615301A; 5Q0615301H; JZW615301J	
				8DD 355 119-481		3Q0615601; 3Q0615601A	
				8DD 355 122-721		5Q0615301A	
				8DD 355 127-971		1K0615301AA; 1K0615301D; 561615301; 561615301B; 5C0615301B; 5Q0615301F; JZW615301H	
				8DD 355 128-451		1K0615601N; 5Q0615601E; JZW698601AQ	
				8DD 355 124-041		1K0615601AA; 5Q0615601D	
				8DD 355 109-521		1K0615301AA; 1K0615301D; 561615301; 561615301B; 5C0615301B; 5Q0615301F; JZW615301H	
				8DD 355 112-121		1K0615601N; 5Q0615601E; JZW698601AQ	
				8DD 355 123-761	1K0615301AA; 1K0615301D; 561615301; 561615301B; 5C0615301B; 5Q0615301F; JZW615301H		
				8DD 355 116-972	1K0615601AA; 5Q0615601D		







Set pastiglie freno



Disco freno

Volkswagen

PRODUTTORE	MODELLO	TIPO DI VEICOLO	ANNO	ARTICOLO	CODICE ARTICOLO	CODICE OE				
Volkswagen	Golf VII (5G1, BQ1, BE1, BE2)	e-Golf	a partire da 03.14		8DB 355 020-271	5Q0698451C; 5Q0698451N; 8V0698451; 8V0698451B; 8V0698451F				
					8DB 355 023-171	2K5698151; 2K5698151A; 2K5698151B; 2Q0698151F; 5Q0698151D; 5Q0698151				
					8DB 355 026-561	5Q0698451C; 5Q0698451N; 8V0698451; 8V0698451B; 8V0698451F				
					8DB 355 020-191	5Q0698151; 5Q0698151B; 8V0698151; 8V0698151A; 8V0698151B; 8V0698151D; 8V0698151G				
					8DB 355 021-951	5Q0698151C				
					8DB 355 026-541	5Q0698151; 5Q0698151B; 8V0698151; 8V0698151A; 8V0698151B; 8V0698151D; 8V0698151G				
						8DD 355 128-001	1K0615301K; 1K0615301T; 5C0615301A; 5Q0615301H; JZW615301J			
						8DD 355 123-761	1K0615301AA; 1K0615301D; 561615301; 561615301B; 5C0615301B; 5Q0615301F; JZW615301H			
						8DD 355 116-971	1K0615601AA; 5Q0615601D			
						8DD 355 116-972	1K0615601AA; 5Q0615601D			
				8DD 355 109-521		1K0615301AA; 1K0615301D; 561615301; 561615301B; 5C0615301B; 5Q0615301F; JZW615301H				
				8DD 355 109-581		1K0615301K; 1K0615301T; 5C0615301A; 5Q0615301H; JZW615301J				
				8DD 355 109-582		1K0615301K; 1K0615301T; 5C0615301A; 5Q0615301H; JZW615301J				
				8DD 355 122-592		1K0615301AA; 1K0615301D; 561615301; 561615301B; 5C0615301B; 5Q0615301F; JZW615301H				
				8DD 355 123-531		1K0615301K; 1K0615301T; 5C0615301A; 5Q0615301H; JZW615301J				
				8DD 355 124-041		1K0615601AA; 5Q0615601D				
				8DD 355 127-971	1K0615301AA; 1K0615301D; 561615301; 561615301B; 5C0615301B; 5Q0615301F; JZW615301H					
				Volkswagen	Up (121, 122, BL1, BL2)	e-Up	a partire da 07.13		8DB 355 031-481	180698151; 1J0615115; 1J0698151; 1J0698151A; 1J0698151B; 1J0698151C; 1J0698151H; 1J0698151J; 1JE698151B; 1S0698151; 1S0698151A; 1S0698151B; 5C0698151A; 5Z0698151A; 5Z0698151B; 6C0698151; 6C0698151A; 6C0698151B; 6C0698151C; 6Q0698151; 6R0698151A; 6RD698151A; JZW698151A; SHZ3501082
									8DB 355 008-591	180698151; 1J0615115; 1J0698151; 1J0698151A; 1J0698151B; 1J0698151C; 1J0698151H; 1J0698151J; 1JE698151B; 1S0698151; 1S0698151A; 1S0698151B; 5C0698151A; 5Z0698151A; 5Z0698151B; 6C0698151; 6C0698151A; 6C0698151B; 6C0698151C; 6Q0698151; 6R0698151A; 6RD698151A; JZW698151A; SHZ3501082
									8DD 355 118-261	1S0615301; 1S0615301H
8DD 355 129-441	1S0615301; 1S0615301H									
	8DD 355 125-391	1S0615301J; 1S0615301L; 1S0615301M								



HELLA S.p.A.
Via B. Buozzi, 5
20090 - Caleppio di Settala (MI)
Tel : 02.98835.1
Fax : 02.98835.835-836
E-mail : info.it@hella.com
Internet : www.hella.it

Ufficio di Torino
Viale Gandhi, 23
10051 Avigliana (TO)
Tel : 02.98.835.310
Fax: 02.98.835.353

HELLA PAGID GmbH
Lüscherhofstraße 80
45356 Essen, Germany
www.hella-pagid.com
service@hella-pagid.com

© HELLA PAGID GmbH
J01651/02.20
Con riserva di modifiche ai prezzi e ai contenuti