

INSPIRED BY INNOVATION
HELLA HEADLAMP DESIGN



IT IS AN EXCITING AND INTERESTING TIME TO BE IN THE GLOBAL AUTOMOTIVE INDUSTRY AT PRESENT – WITH ACCELERATING TECHNOLOGY INNOVATION AND MARKET TRANSFORMATION. HELLA PARTICIPATES AND DRIVES MANY OF THESE TRENDS, SO IS UNIQUELY POSITIONED TO ENSURE YOU MASTER AND PROFIT FROM THEM.

FOR DECADES WE HAVE BEEN CONSISTENTLY DELIVERING MARKET DEFINING FUNCTIONALITY TO OUR ROADS WITH AN EMPHASIS ON QUALITY, EFFICIENCY AND DESIRABILITY. OUR DESIGNS SEEK TO CHALLENGE THE STATUS QUO AND FURTHER EXPLORE THE BOUNDARIES OF LIGHTING TECHNOLOGY TO SET NEW STANDARDS OF SAFETY AND PERFORMANCE.

THROUGH OUR PARTNERSHIP WITH YOU, WE ASPIRE TO DEVELOP SIGNATURE PERFORMANCE PRODUCTS WITH SUPERIOR FUNCTIONALITY AND INNOVATIVE DNA TO PAVE THE WAY TO THE FUTURE OF AUTOMOTIVE LIGHTING TOGETHER.

[DR. NICOLAS WIEDMANN, MEMBER OF THE EXECUTIVE BOARD]



THE BIRTH OF **INNOVATIVE LIGHTING AND VEHICLE TECHNOLOGY.**

Founded over 100 years ago, HELLA is an international, publicly listed family business, specializing in innovative lighting systems and vehicle electronics. Since the beginning, the highest quality standards and innovative practices have set the direction within the company, which is true even to this day. The hunger for the next great breakthrough has led HELLA to be counted amongst the technological forerunners of the industry, thus cementing its position as an integral player in the automotive market and positioning it to offer unique solutions in the aftermarket and special applications segment.

HELLA REALIZES A SIGNATURE **FOR SPECIAL VEHICLES.**

HELLA has played an active role in the specialist vehicles market through its Special Applications division for several years now. Through synergizing its numerous strengths and capacities as a tier 1 supplier, the company designs, develops and produces innovative lighting and electronics solutions for a great number of manufacturers in target groups such as agriculture, construction, trucks, buses and RVs, to name a few. On account of high levels of technological, process and quality expertise that HELLA has developed through working with OE customers in the automotive industry, holistic end-to-end solutions are replicated seamlessly for the smaller-volume vehicle manufacturers. Moreover, HELLA's economical and technically efficient solutions also guarantee a signature style and strong design in accordance with customer specifications.

THE FUTURE IS CREATED IN THE MIND **AND SKETCHED ON A SHEET OF PAPER.**

Inspiration is always the building block of any design idea – an initial sketch, the first stroke of a brush. Gradually, the lines and thoughts combine to give shape to the final product. But how exactly does this look, the conceptual phase and the collective work between the customer and the HELLA resource personnel? To get a deeper understanding of this, we take a look over the shoulders of the designers – in fact, we take a look into their sanctuary: the sketchbook.

HELLA LEARNS FROM LIGHT – AND REMOULDS IT.

1 ONLY THOSE WHO ARE FASCINATED BY LIGHT
WILL STUDY LIGHT.

It all started with a flame, a flickering light and an inspiration. The German entrepreneur Sally Windmüller founded the Westfälische Metall-Industrie Aktien-Gesellschaft (The Westphalian Metal Industry Company) on June 11, 1899. At that time, the product range consisted primarily of bulb horns, candles and kerosene lamps for carriages. This, however, did not satisfy the strategic vision of the young visionary. Fascinated by light and driven by the passion of innovation, within a time span of just ten years, he introduced the "System HELLA" acetylene headlamp, which completely revolutionized the automotive world. The magnitude of the leap can only be understood by the fact that in comparison to standard candles and kerosene lamps, the lighting effect of this headlamp was fifty times brighter, thus kickstarting the beginning of an era.

2 ONLY THOSE WHO STUDY LIGHT
LEARN TO UNDERSTAND LIGHT.

HELLA believes light to be an integral part of safety on the road, which is why it devotes countless resources to understanding it. Through cutting edge research techniques, the highest quality expertise and innovative design philosophy, lighting products and lighting systems are developed. Since the founding of the company in 1899, the ethos to constantly innovate, lead and grow has not changed. In the rapidly changing market of today, HELLA strives to support modern vehicle design with a focus on modernity and minimalism.

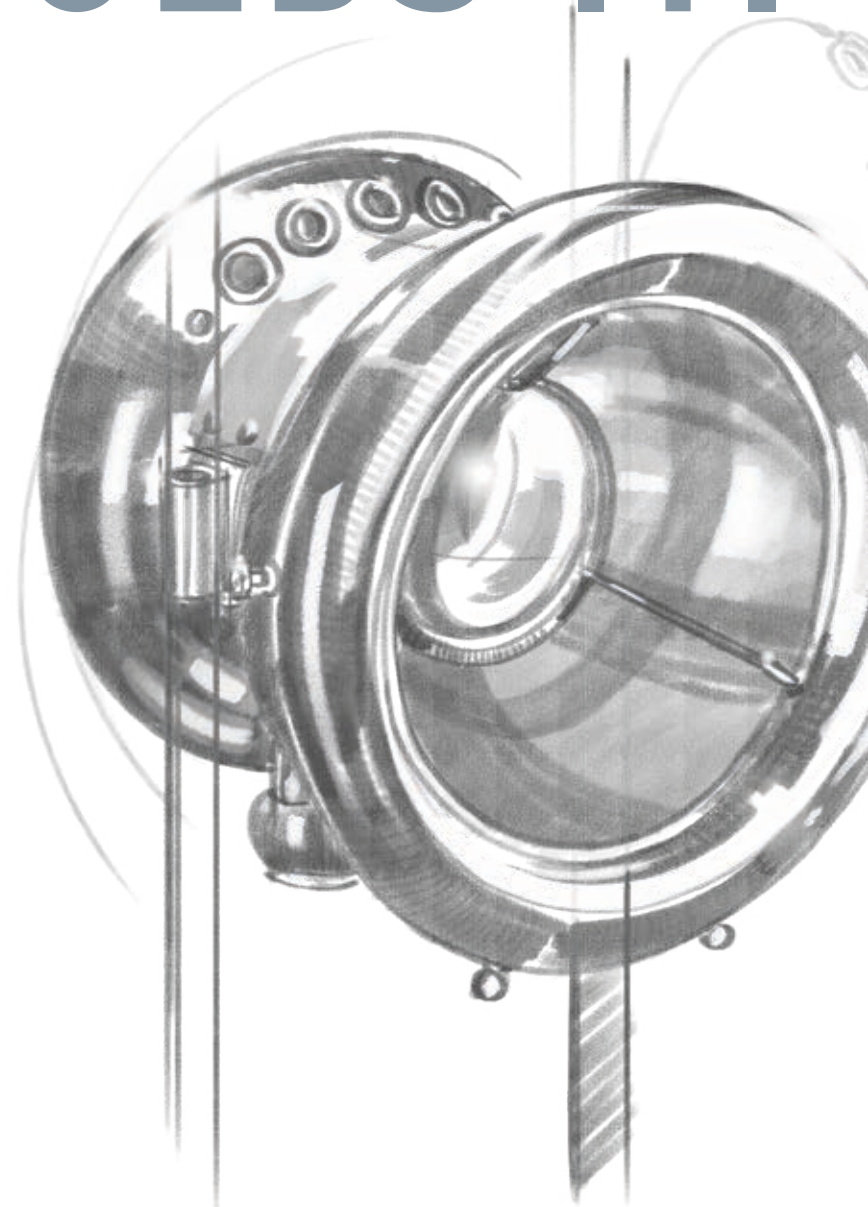



ONLY THOSE WHO UNDERSTAND LIGHT
CAN BRING LIGHT INTO FORM.

Vision is developed and refined when unique strengths are channeled strategically and efficiently. High levels of technological, process and quality expertise do not just enable holistic solutions to be realized, they also open up new, individual possibilities. HELLA is surging forward into new frontiers, especially in regard to modular design. Modular building block systems provide in-house engineers, designers and controllers a variety of design possibilities, ranging from the futuristic to the classic. The customer specifies the installation opening and determines the design – HELLA produces the module. Thus, customer-specific and, above all, future-oriented headlamps are developed.

ONLY THOSE WHO BRING LIGHT INTO FORM
CAN REVOLUTIONIZE LIGHT.

HELLA innovates to be able to realize the future today. Since the creation of the automobile, HELLA has been busy setting and resetting milestones in lighting technology, thus pioneering countless lighting products and lighting systems. This is because the perfect integration of a headlamp into the vehicle is always based on modern, tailor-made design and the harmonious interaction of innovative lighting systems. This means: optimum illumination of the road, safety, and driving comfort.

In this respect, the HELLA design philosophy follows a clear goal: revolutionary forms coupled with the latest technology, in accordance with the wishes of the client. Through tapping into the full spectrum of sophisticated lighting technology knowledge, HELLA is able to break new ground in vehicle design and to generate a brand-specific appearance for its customers.

BUILDING THE BRIDGE TO THE FUTURE
THROUGH EXCELLENCE.

To ensure safety, quality and readiness for the future, HELLA products are tested under the strictest standards to comply with the original equipment manufacturer quality requirements. Only those products that satisfy these may be used to light the way as shining examples.

HYMER HEADLAMP

MODERN DESIGN MEETS

EXCELLENT PERFORMANCE.

With HELLA on board, caravans and motorhomes can rely on safety, quality and performance, thanks to HELLA's prowess of combining technological competence and innovative design. Caravans and RVs are famous for their inner architecture, but through the use of HELLA technology, we are able to complement the overall design of the complete vehicle.

INITIAL CONCEPT AND STYLING

The triangular form is the building block for the design theme, which contributes to the various lighting functions and emphasizes the beauty of the vehicle layout.

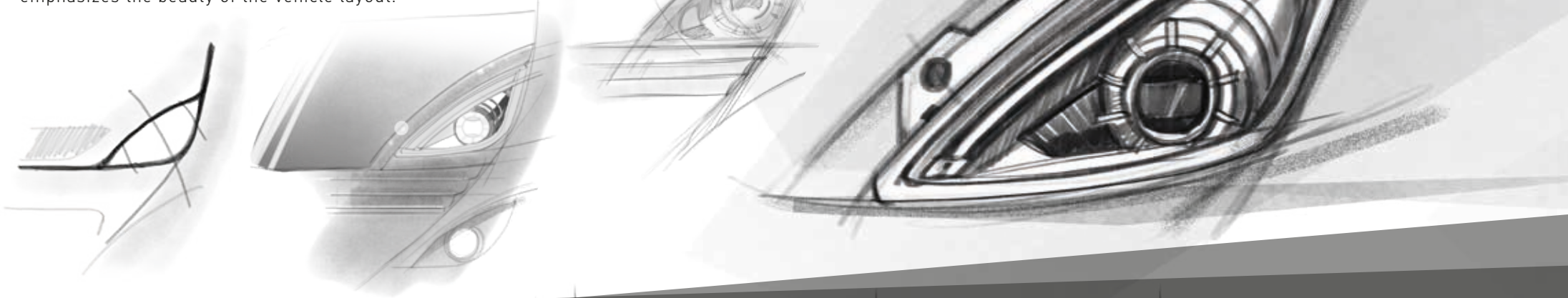

TECHNOLOGICAL HIGHLIGHTS

Lighting the way! Custom design meets intelligent electronic control: three light functions beam out of a single LED-fed light guide.

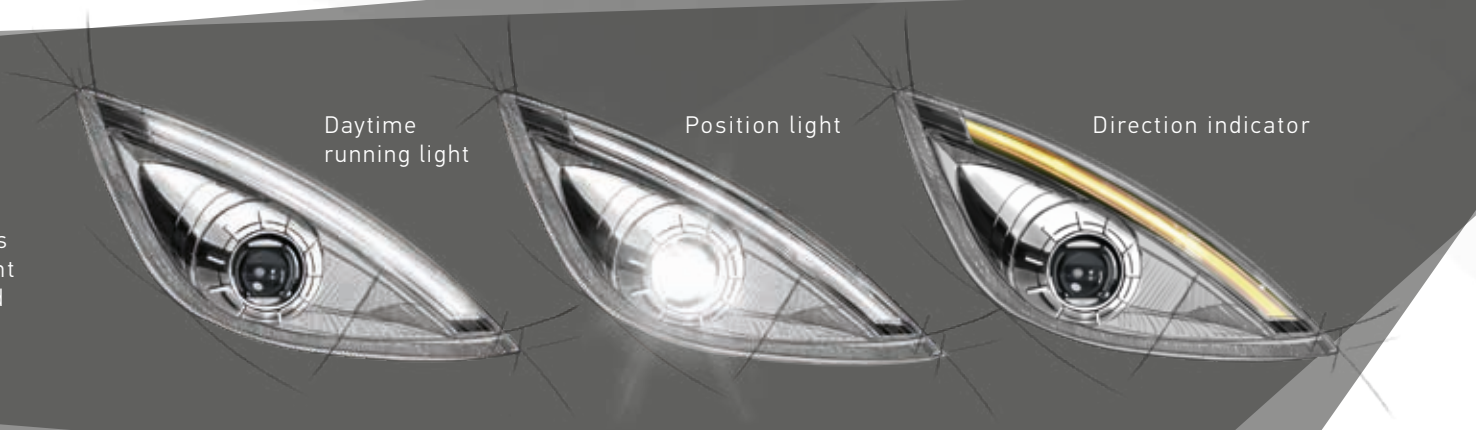

FINAL DESIGN

The form that unifies light design and lighting expertise. Inspired by nature, the organic shape ensures powerful illumination, with the robust housing lending additional stability to the unique cover lens.

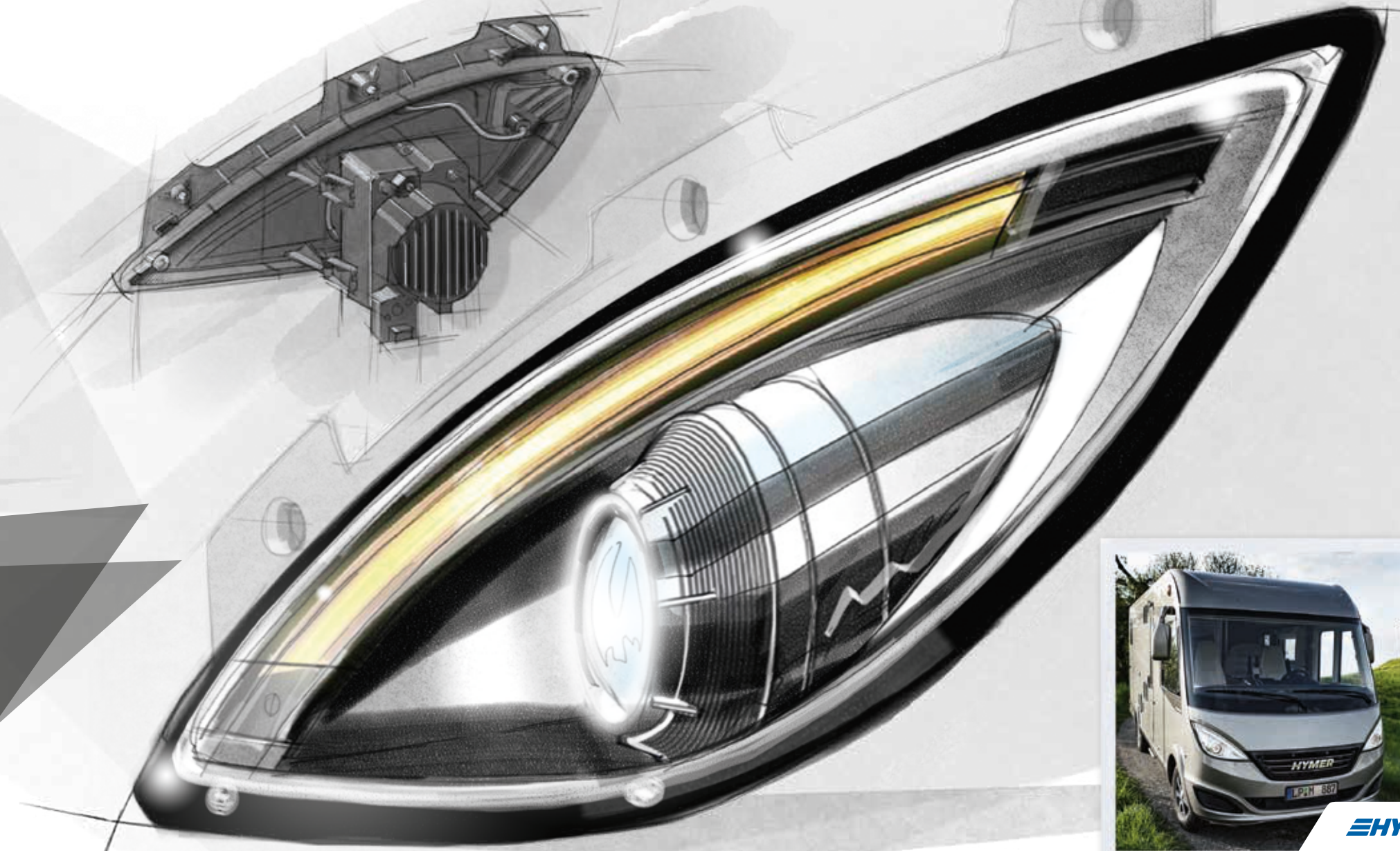

HYMER

EVOBUS HEADLAMP

A SYMMETRY OF DESIGN

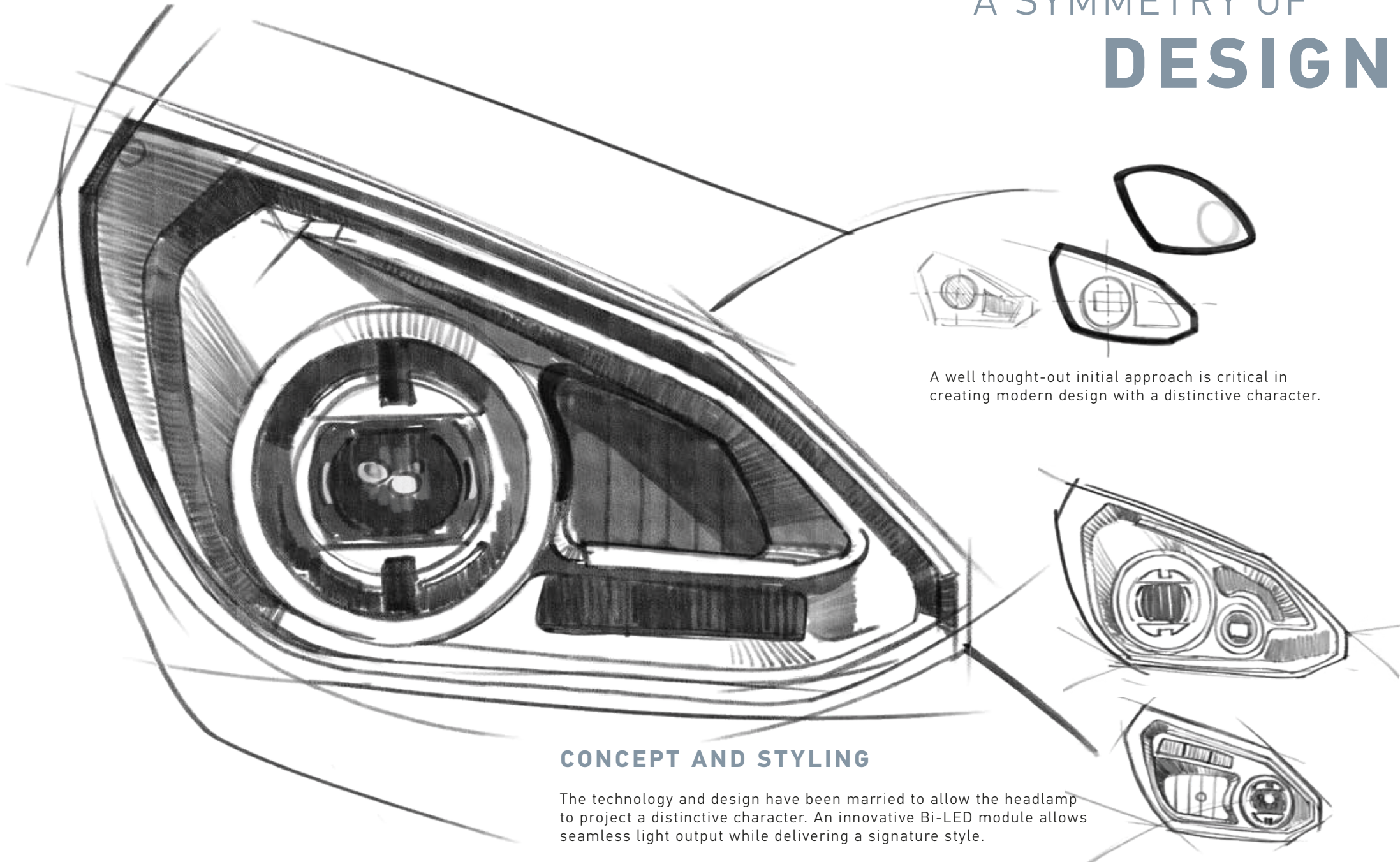

A well thought-out initial approach is critical in creating modern design with a distinctive character.

CONCEPT AND STYLING

The technology and design have been married to allow the headlamp to project a distinctive character. An innovative Bi-LED module allows seamless light output while delivering a signature style.

AND QUALITY.



EVOBUS HEADLAMP

A SYMMETRY OF

DESIGN

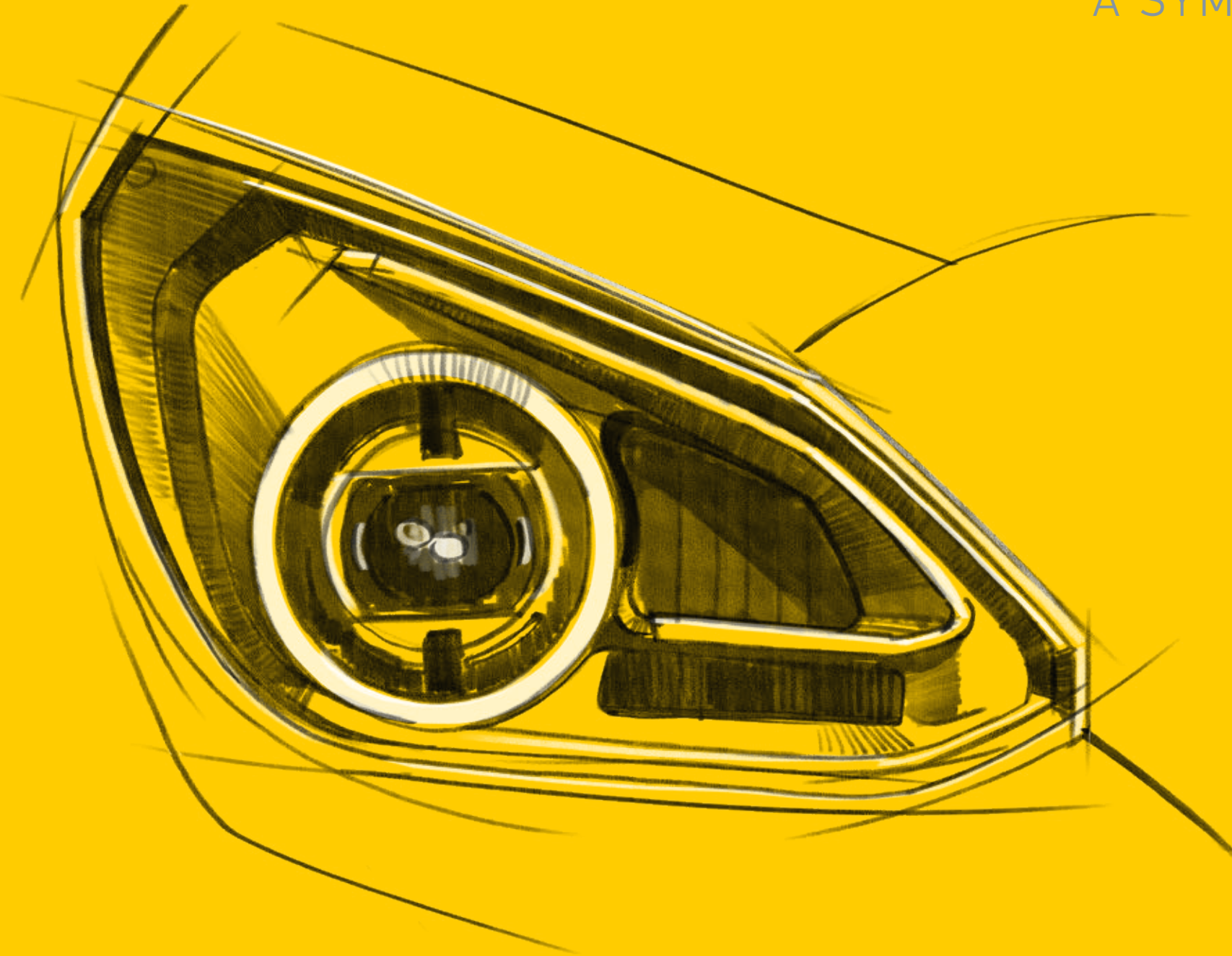

AND QUALITY.

Illuminating the way forward with a reassuring sense of safety, HELLA created a headlamp that combines timeless design and sophistication with superior quality. Clean lines and smooth angles complement each other perfectly while characterizing the distinctive design.

Bi-LED (high and low beam)

Daytime running light and position light



FINAL DESIGN

A true embodiment of modern design, the result is the perfect symbiosis of headlamp and vehicle.

VAN HOOL HEADLAMP

GROUND BREAKING LIGHT EFFICIENCY

FROM ANOTHER DIMENSION.

Dynamic lines blend with classic forms. The new generation of coaches is redefining the way we look at buses, and HELLA is front and center in doing this by enhancing the front of the bus with its custom-designed, high-performance headlamps. The future-oriented HELLA LED lighting technology projects safety on to the road, thus providing comfort to all those in the bus.

INITIAL CONCEPT AND STYLING

Stroke by stroke the innovative lighting elements are integrated into a modern design concept, allowing the full performance of the technology to be deployed.

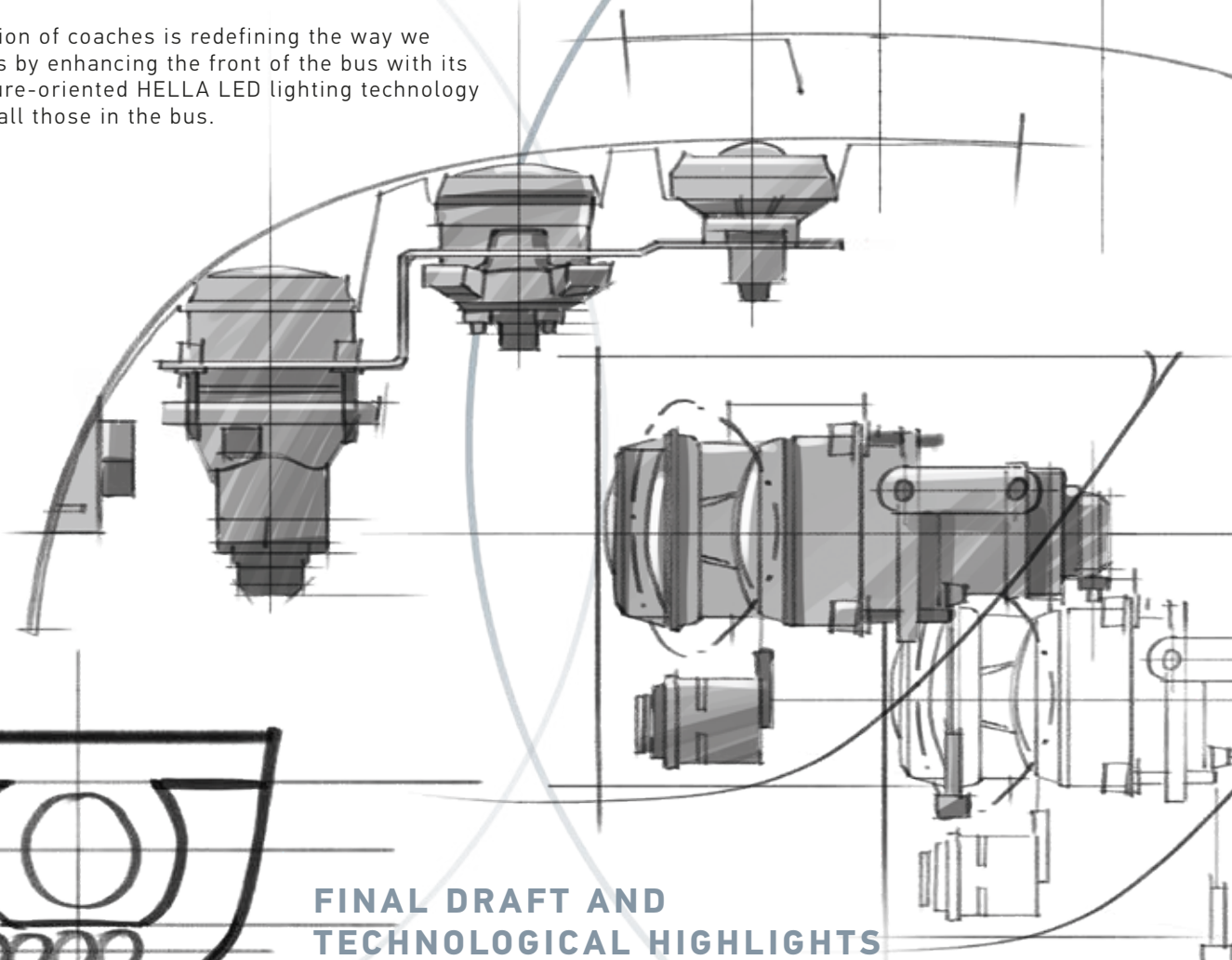
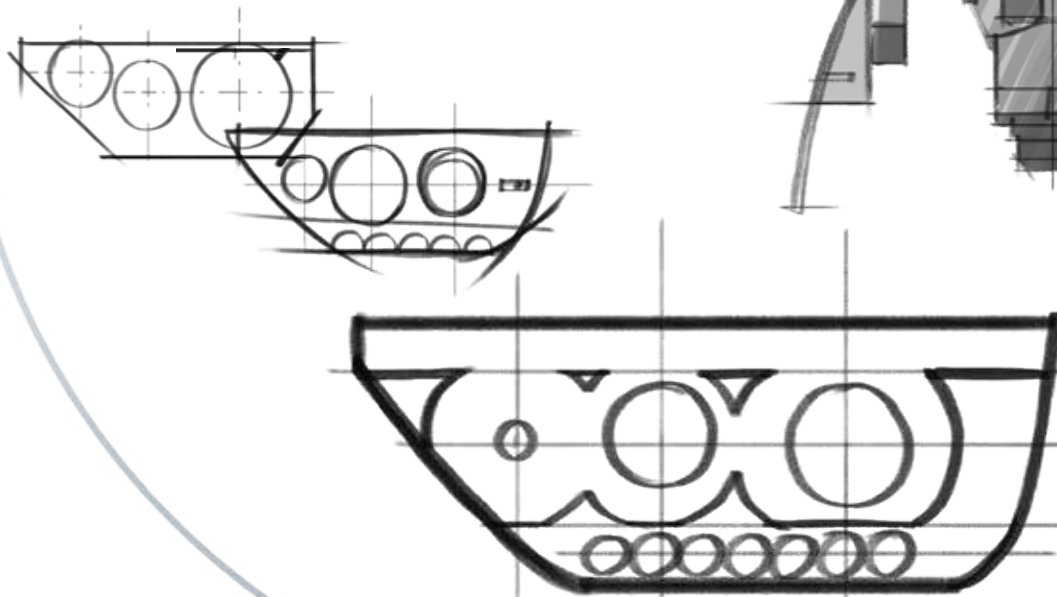

FINAL DRAFT AND TECHNOLOGICAL HIGHLIGHTS

Multidimensional radiance, shaped and tamed but redefined at the very latest when the headlamps are switched on.

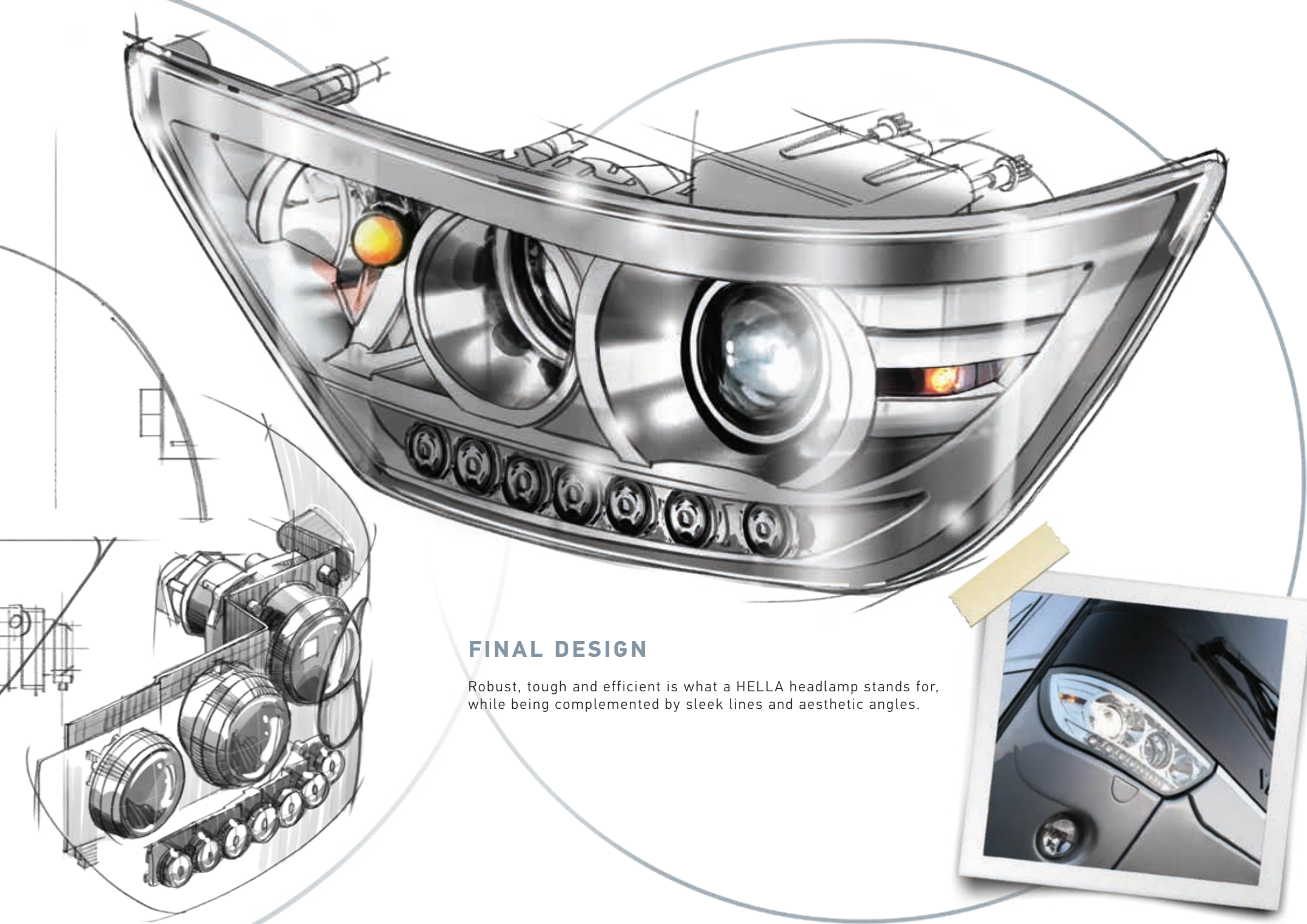

FINAL DESIGN

Robust, tough and efficient is what a HELLA headlamp stands for, while being complemented by sleek lines and aesthetic angles.

STEYR HEADLAMP

LIGHTING TECHNOLOGY AND LIGHT DESIGN

FOR THE HIGHEST DEMANDS.

Adverse weather conditions, rough terrain, heavy transport. Vehicles that are regularly exposed to the highest of loads must work perfectly. HELLA is well aware of the challenges and works tirelessly to overcome these so that our lights continue to function even when far from the nearest road. With HELLA's advanced technology integrated into a custom-made headlamp we are able to increase driver productivity while projecting an exclusive design.

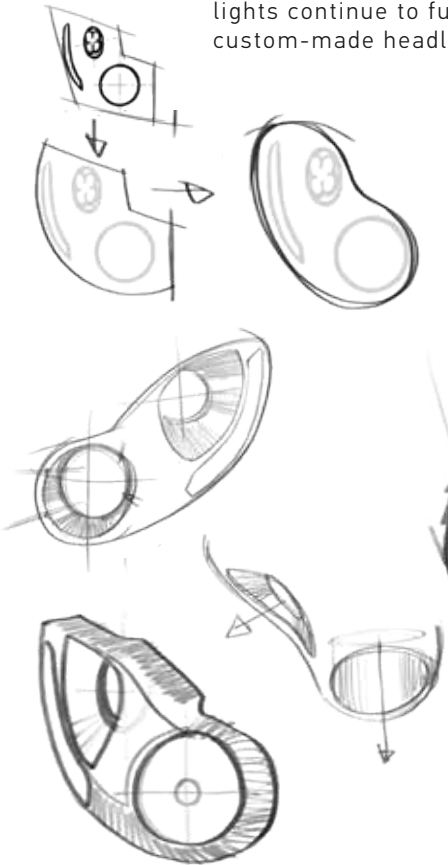

INITIAL CONCEPT AND STYLING

From the asphalt to the field: Automotive design and technological expertise have revolutionized the agricultural vehicle sector.



TECHNOLOGICAL HIGHLIGHTS

Highly developed lighting solutions, with modern integration, according to customer specifications: headlamp, work light and styling light in perfect harmony.

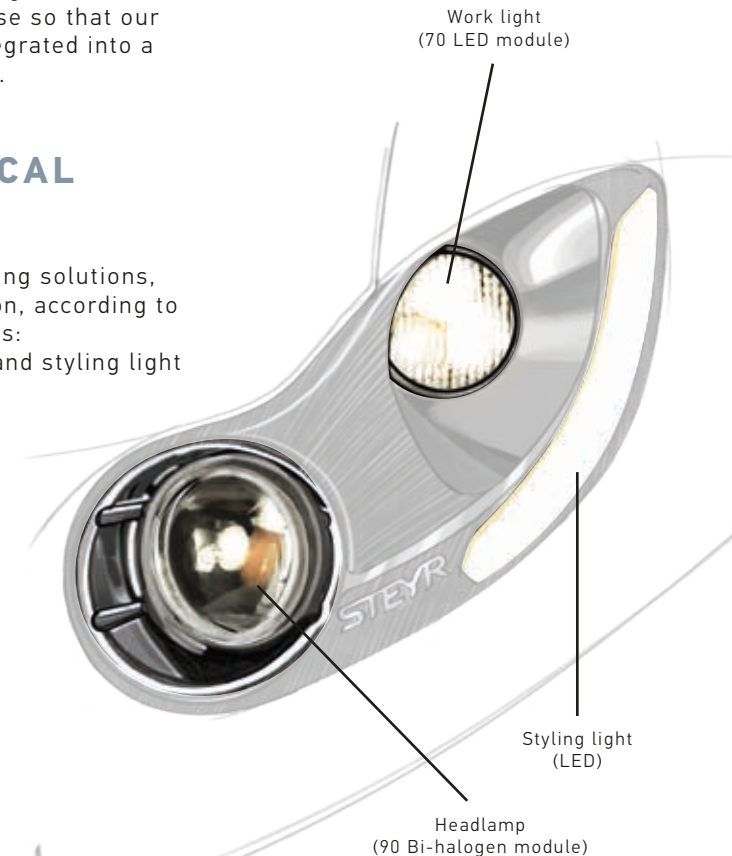

FINAL DESIGN

You can see the ambition of a pro in the eyes. And these are completely focused. Strong in character, they radiate in a well-toned body and ensure exceptional performances.





CASE IH HEADLAMP

INNOVATIVE ILLUMINATION STRENGTH – PIONEERING AND TREND SETTING.

The agricultural terrain demands maximum performance from the vehicles built to operate on it. The equipment is permanently put to the test – and must withstand endless periods of use. The headlamps in particular must cut through the darkness even when the visibility is low and the air is thick with dust. The purposeful appearance of this lighting unit illustrates this point: with integrated HELLA Power, every challenging task becomes an easy exercise.

INITIAL CONCEPT AND STYLING

First of all, the ideas were honed, and then the designers sharpened their pencils. Powerful light modules served as the motivation to develop the shape of this headlamp.

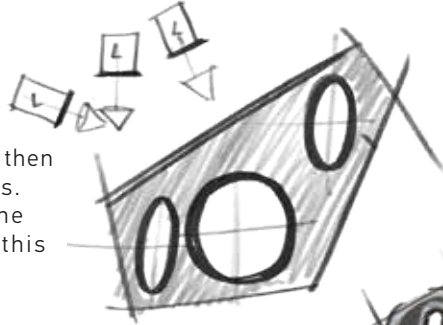
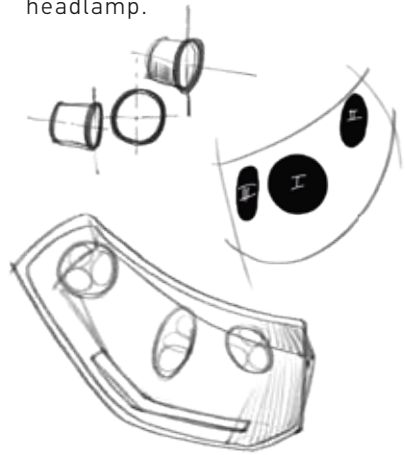

FINAL DESIGN

The automotive expression strengthened through defined confidence. Striking features and soft lines ensure a look that captivates. The headlamp brightness make it clear that the time of day and weather are just minor details.

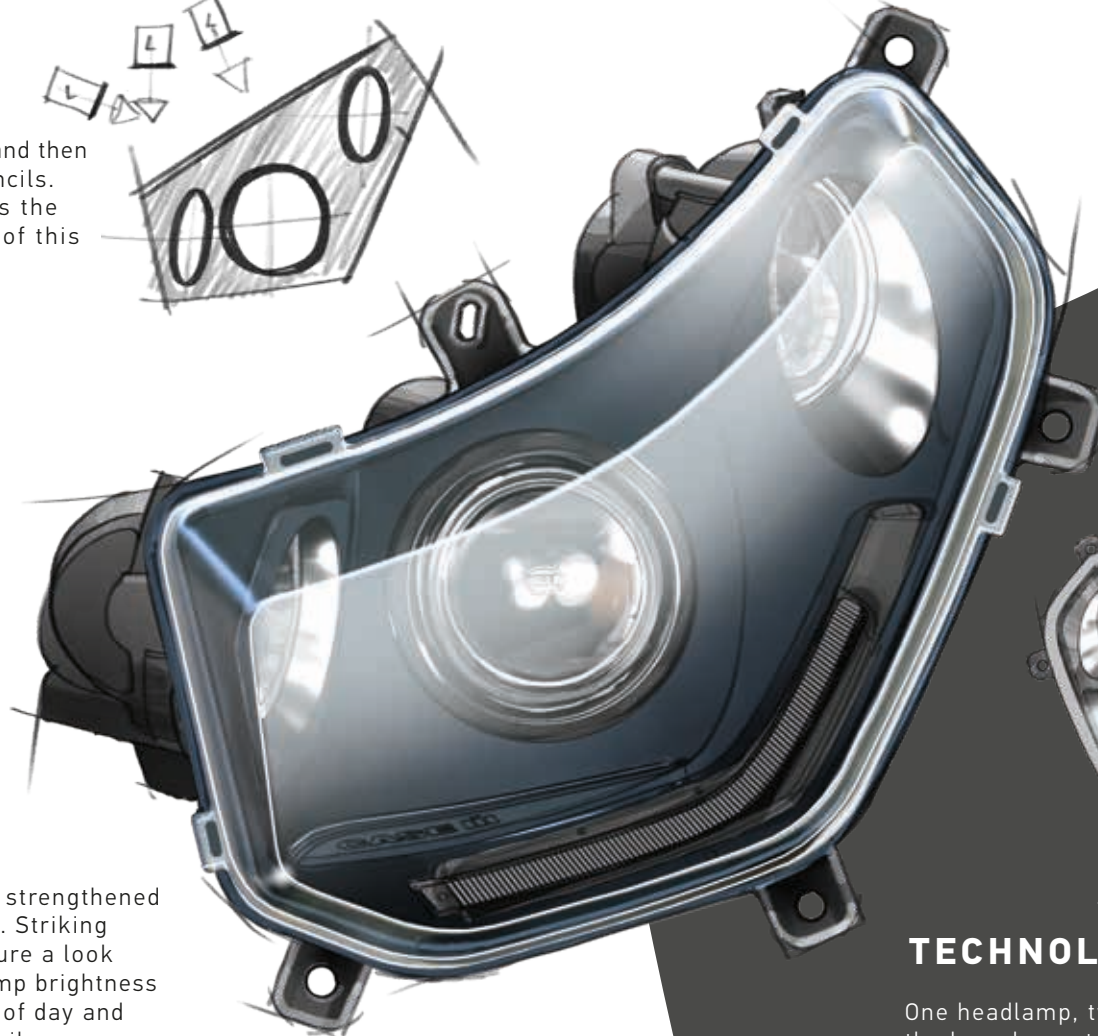

Work light
(70 LED module)

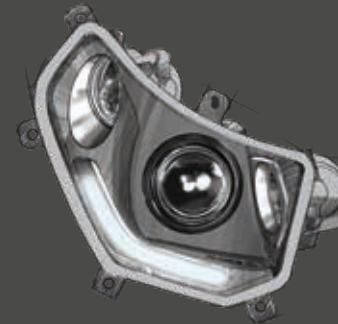

Styling light (LED)



Main light
(90 Bi-halogen module)

TECHNOLOGICAL HIGHLIGHTS

One headlamp, two work lights and a styling light were the key elements in the design development.

BMW MOTORBIKE HEADLAMP

CLASSIC HEADLIGHT

WITH A MODERN DESIGN.

HELLA redefines standards and delivers lighting design as well as lighting safety in superior form over and over. The muscular body of this bike, with its strong lines, demands a headlamp that provides the finishing touch to its beating heart of a racing machine. The solution was superior and groundbreaking in equal measure. By redefining the classic round headlamp, the designers from BMW and HELLA have together set another milestone in the development of two-wheeler, customer-specific headlamps.

INITIAL CONCEPT AND STYLING

Inspired by the circular form and modernism acquired through understanding the classical. A transformation that meets the zeitgeist and strengthens the character of the machine.

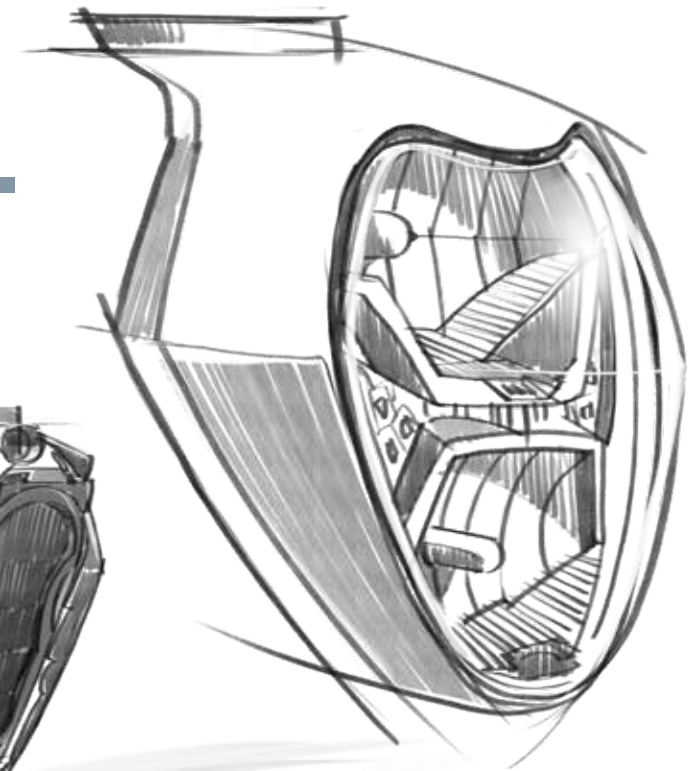
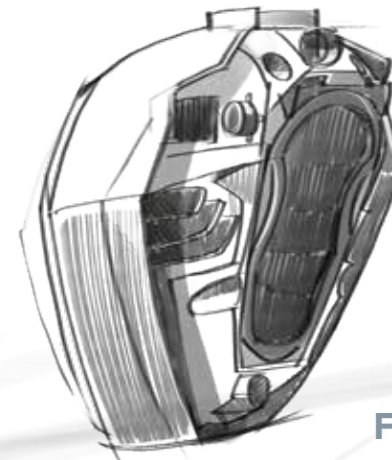
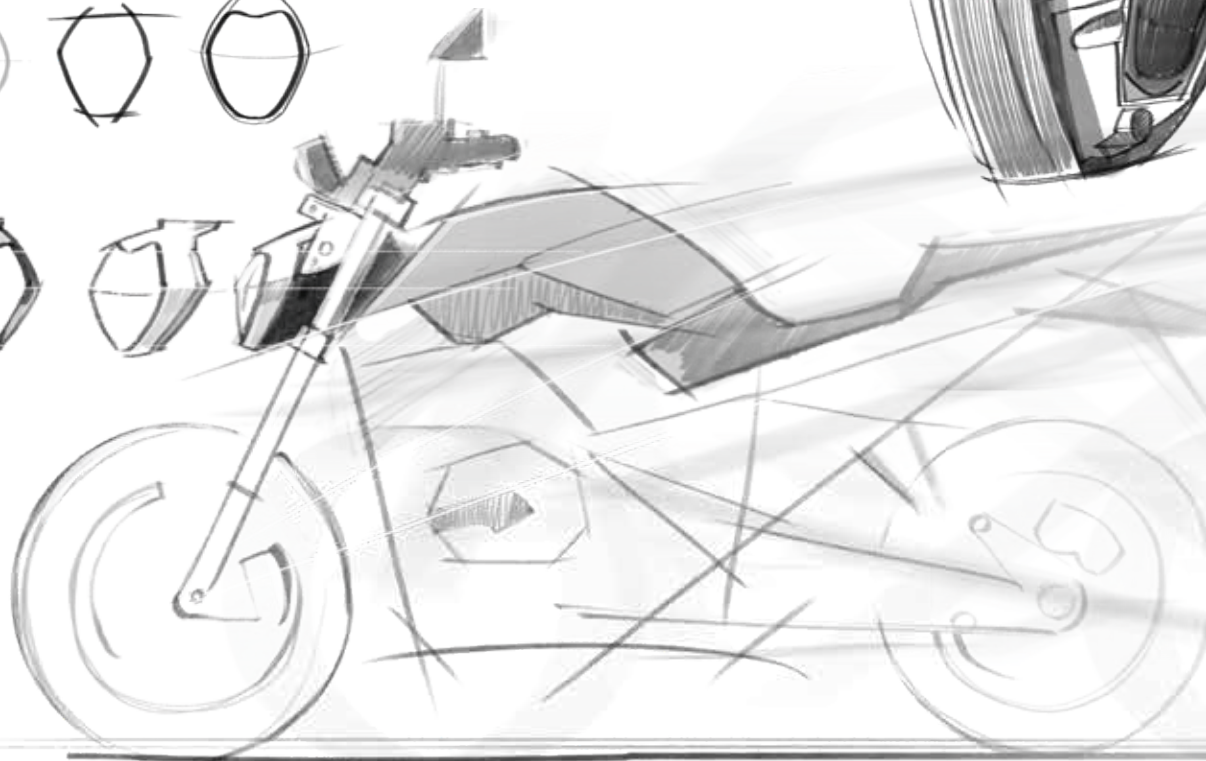
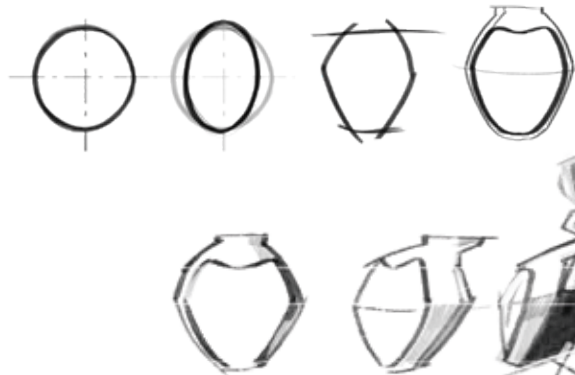

FINAL DRAFT

Versatile lighting performance packaged in a compact headlamp. The design is a true thoroughbred that conquers every challenge.

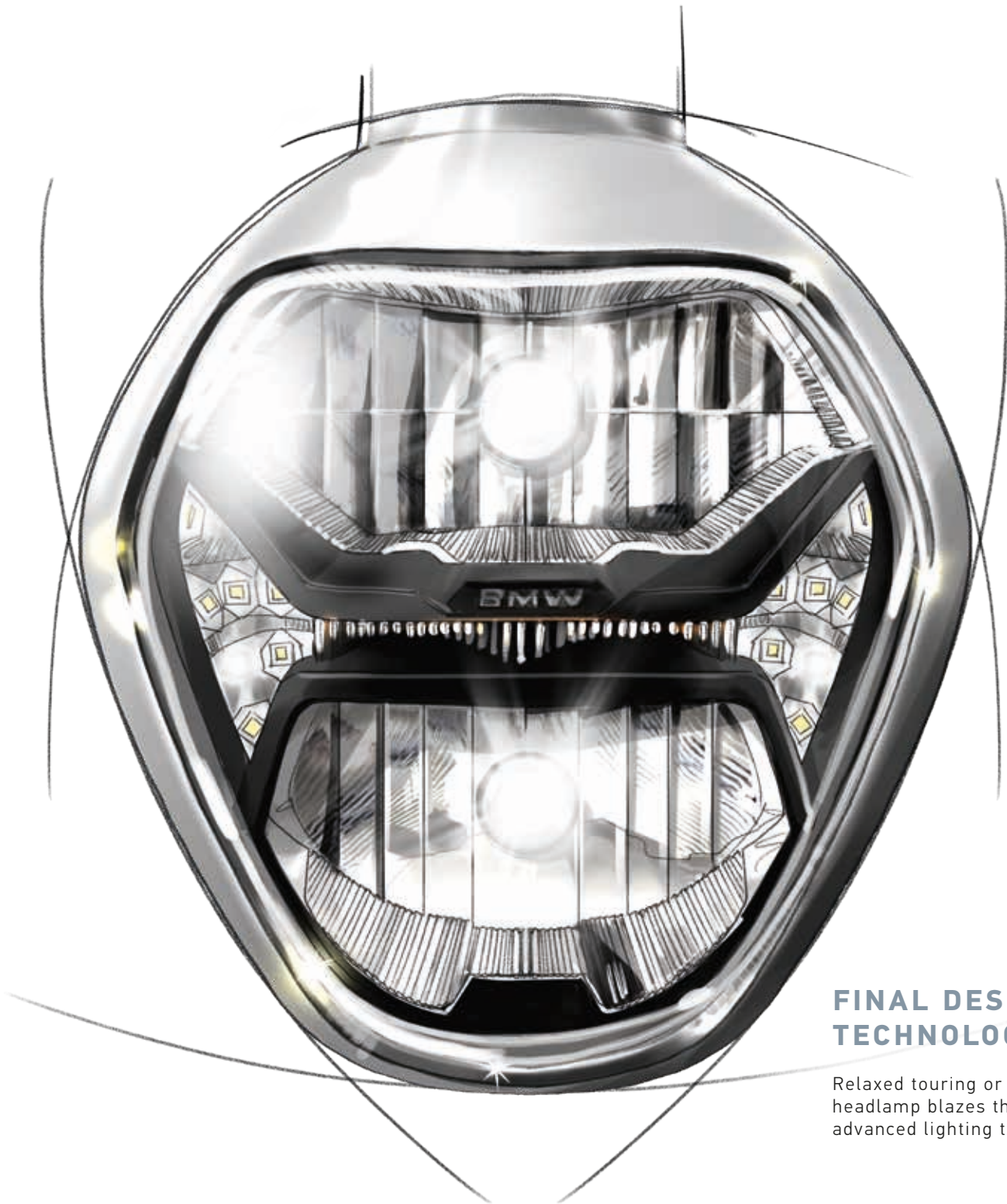
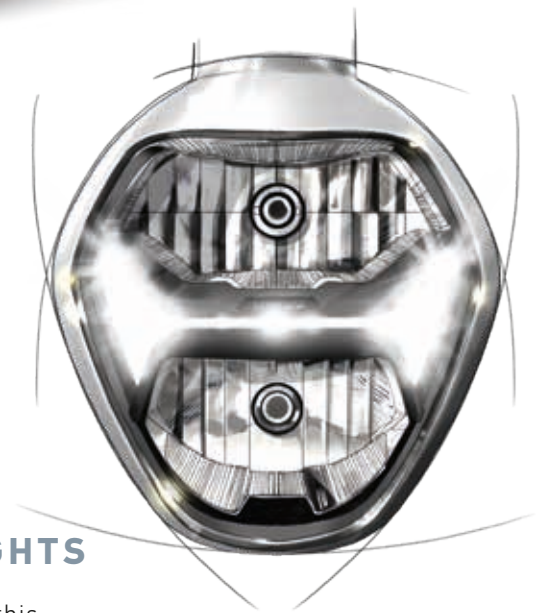

photo: BMW AG



FINAL DESIGN AND TECHNOLOGICAL HIGHLIGHTS

Relaxed touring or powerful performance – this headlamp blazes the trail, thanks especially to the advanced lighting technology.

VISION AND INNOVATION

THE FUTURE NEEDS SOLUTIONS –

HELLA DEVELOPS THEM.

We live in a modern world, a world which revolves ever faster due to the innovations being made at an accelerating rate. HELLA is one of the actors driving this transition, setting revolutionary lighting benchmarks and creating the path for a promising technological lighting future.

This is emphasized by the Digital Light generation. Technologies such as AFS, Matrix LED and LASER are already lighting up roads today. However, the future of light will open up dimensions hardly imaginable today but soon a reality, thanks to HELLA. Examples of HELLA's leading innovations are Liquid Crystal Display (LCD) or Digital Mirror Devices (DMD), which will soon be changing how we view the road in the near future.

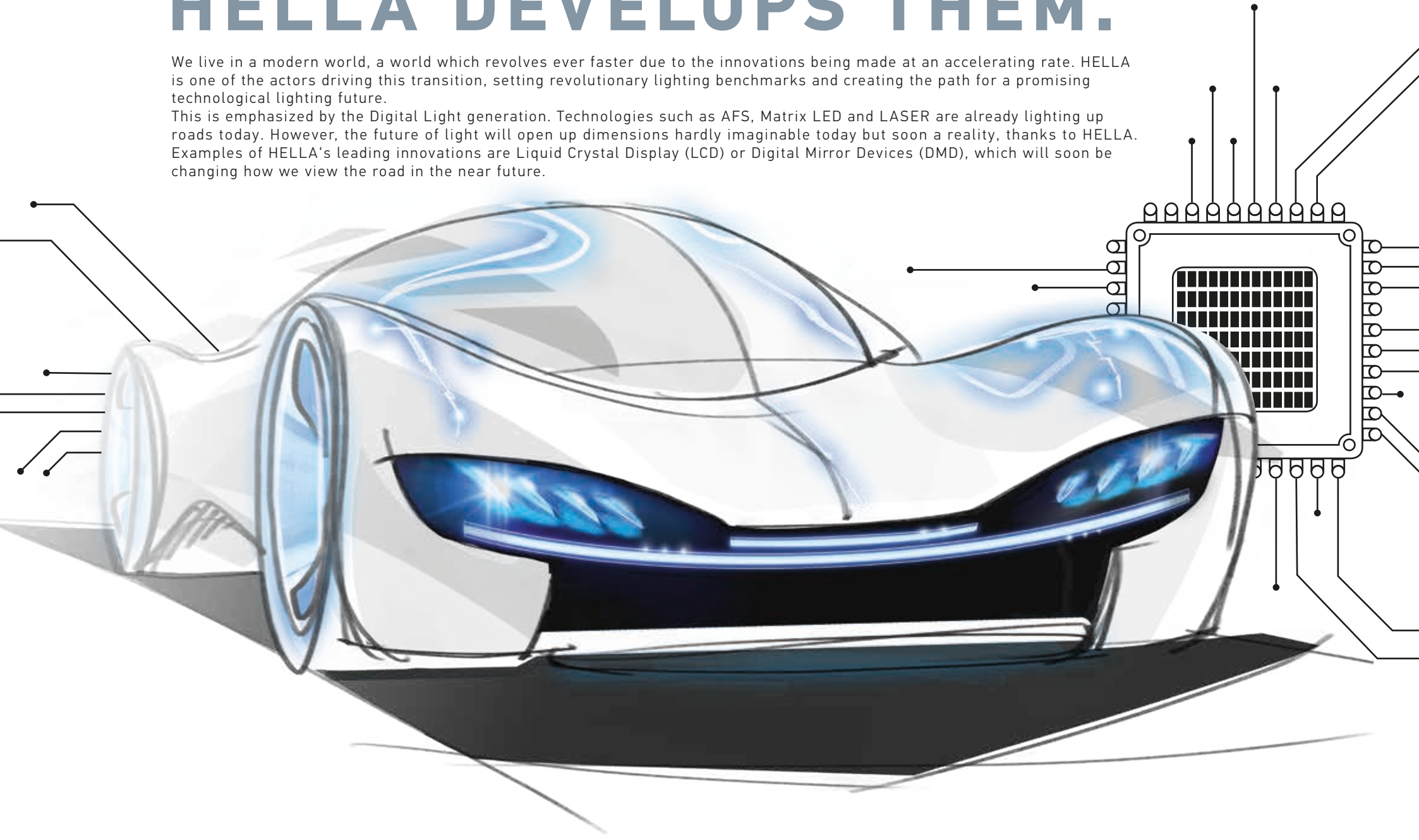

AFS (ADAPTIVE FRONTLIGHT SYSTEM) INTELLIGENT LIGHT DISTRIBUTION, REDEFINED.

The capabilities of light appear limitless – once they have been recognized, honed and realized. AFS (Adaptive Frontlighting System), a cornerstone of intelligent lighting technology, has steered driving in a new direction, although the potential of this system is far from having been completely unlocked. HELLA recognized this as an opportunity and made changes to produce extended profiles, such as for buses, field light profiles for tractors, as well as other applications requiring SOE quality performance. This has all been done while being mindful of achieving better visibility for enhanced safety on the road and beyond.

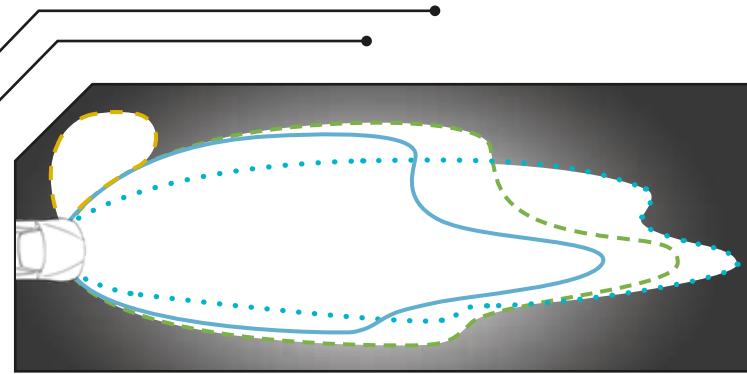

AFS – Light that senses and adapts

MATRIX LED LIGHT THAT REACTS MORE QUICKLY THAN THE HUMAN EYE.

MATRIX LED is an intelligent lighting solution that allows the continual use of high beam lights without them glaring into the view of other drivers. Preceding and oncoming vehicles are detected in good time and blended out within milliseconds, road signs are shown in optimally adjusted light, while all other relevant areas remain fully illuminated. Even in curves, MATRIX LED scans the road, recognizes specific situations and reacts accordingly. It controls the intensity of the light cone automatically, depending on the situation, thus optimizing visibility and enhancing safety.

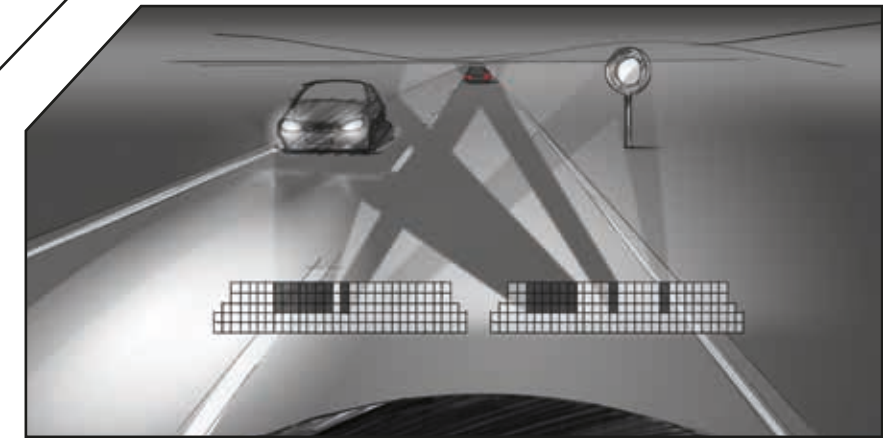

MATRIX LED – Optimally controlled LEDs for precise and ideal light distribution

LASER LONG-RANGE HIGH-PERFORMANCE LIGHTING.

The market is still looking for ways to provide even more light. Laser diodes and high-power LEDs are space-saving elements with the added benefit of producing an explosion of concentrated light intensity. The precision of the laser beam in combination with intelligent LED power shows the great potential of light: enhanced lane area illumination for maximal precision, homogeneity and clarity.

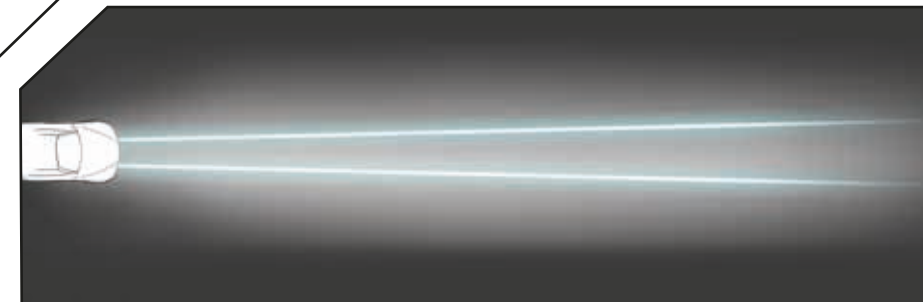

LASER – Targeted road illumination

JOIN US IN SETTING

LIGHTING GOALS!

HELLA colleagues at our locations listed below will be happy to answer any questions. We look forward to exploring exciting opportunities with you and developing a partnership to redefine lighting technology across the world.

HEADQUARTERS
HELLA GmbH &
Co. KGaA

Rixbecker Straße 75
59557 Lippstadt
Deutschland

Tel: +49 2941 38-0
info@hella.com
www.hella.com

AMERICA
HELLA, Inc.

201 Kelly Drive
P.O. Box 2665
Peachtree City, GA 30269
USA

Tel: +1 877 224-3552
www.hellausa.com

ASIA
HELLA Asia
Singapore Pte Ltd

2 International
Business Park
#02-12 The Strategy
Singapore 609930

Tel: +65 6854 7300
singapore@hella.com
www.hellaasia.com

**HELLA Trading
(Shanghai) Co. Ltd.**

11th/F, Block 5, Daning Hub
No. 1898 Gong He Xin Road
Shanghai 200072 P. R. China

Tel: +86 21 6117-6228
www.hellacn.com

**HELLA India
Lighting Ltd.**

6th Floor, Platinum Tower,
Plot no. 184,
Udyog Vihar Phase-1
Gurgaon -122016

Tel: +91 124 4658600
www.hella.co.in

EUROPE
HELLA Fahrzeugteile
Austria GmbH

Handelskai 94-96
1200 Wien
Österreich

Tel: +43 1 60689-20
info-ag-ce@hella.at
www.hella.com/agro

HELLA Limited

Unit 6 Appletree
Industrial Estate
Chipping Warden
Banbury, Oxon
OX17 1LL
England, UK

Tel: +44 1295 662400
hella.sales@hella.com
www.hella.co.uk

HELLA Benelux BV

Celsiusbaan 2, Postbus 1398
3430 BJ Nieuwegein
Nederland

Tel: +31 30 6095611
nl.info@hella.com
www.hella.nl

HELLA A/S

Lundsbjerg Industrivej 13
6200 Aabenraa
Danmark

Tel: +45 7330 3600
info@hella.dk
www.hella.dk

KG Knutsson AB

19181 Sollentuna
Sverige

Tel: +46 8 923000
www.kgk.se

HELLA S.p.A.

Via B. Buozzi, 5
20090 - Caleppio di
Settala Italia

Tel: +39 2 98835-1
infoitalia@hella.com
www.hella.it

LIGHT IN TRANSITION –
THANKS TO ELECTRONIC SIGNALS.

Driven by innovation, HELLA moves daily through a spectrum and depth of electronics. Systematic technological goals are pursued, complex connections are developed and new opportunities are explored, because at HELLA, we believe the next leap in lighting can only be achieved through the help of electronic advancement.

