



**Hella marine**



**LIGHTING YOUR LIFESTYLE**

**WORLD LEADING MARINE LIGHTING**

PRODUCT CATALOGUE



Photo Credit: Haines Hunter

Cover Image Credit: Riviera 46 Sports Motor Yacht

A full-page background image showing a sunset over a body of water. The sky is a mix of purple, pink, and orange, with some dark clouds. The water is calm, reflecting the colors of the sky. In the distance, a coastal town with buildings and a few boats is visible on the horizon.

# Take us on your next adventure

---

At Hella marine, we strive to be the beacon of innovation and reliability in the marine lighting industry, setting new standards for performance, safety, and environmental responsibility.

Guided by our unwavering commitment to excellence, we are the first choice of boat builders, marine enthusiasts, and commercial operators worldwide. Through cutting-edge technology, we illuminate the seas with energy-efficient, durable, and aesthetically pleasing lighting solutions that enhance safety and optimize your marine experience.



APELO LIGHTING



NAVIGATION



LIGHT BARS



WORK LAMPS



COURTESY



INTERIOR / EXTERIOR

# Contents

## Hella marine

|                             |   |
|-----------------------------|---|
| Lighting Excellence Assured | 6 |
| Design, Manufacture, Test   | 7 |

## Apelo Ecosystem

|                                  |    |
|----------------------------------|----|
| Apelo Light Controller & App     | 8  |
| Apelo EuroLED 75 RGB/W Downlight | 11 |
| Apelo RGB Step Lamp              | 11 |

## Apelo Underwater Lights

|                             |    |
|-----------------------------|----|
| Synchronised Vibrant Colour | 12 |
| A1 Polymer 1800 Lumen       | 14 |
| A2 Aluminium 3000 Lumen     | 15 |
| A2 Bronze 3000 Lumen        | 16 |
| A3 Bronze 6000 Lumen        | 17 |

---

## Sea Hawk Light Bars

|                          |    |
|--------------------------|----|
| Choosing the Right Light | 18 |
| Sea Hawk-470 Edge Light  | 20 |
| Sea Hawk-470             | 21 |
| Sea Hawk-350             | 21 |

## Work Lamps

|                     |    |
|---------------------|----|
| Define How You Work | 22 |
| Work Lamps          | 24 |
| Deck Lamps          | 26 |
| Round               | 27 |
| High Output         | 28 |
| Search Lamps        | 30 |

---

## Navigation Lights

|                      |    |
|----------------------|----|
| Setting the Standard | 32 |
| IMO COLREG 72        | 34 |
| NaviLED Compact      | 36 |
| NaviLED Deck Mount   | 37 |
| NaviLED Tri-Colour   | 37 |
| NaviLED Pro          | 38 |
| NaviLED 360          | 40 |

## Interior Lights

|                         |    |
|-------------------------|----|
| Lighting Your Lifestyle | 42 |
| Down Lights             | 44 |
| Strip Lamps             | 47 |
| Utility / Engine Room   | 48 |
| Chart / Reading Lamps   | 50 |

---

## Courtesy Lights

|                          |    |
|--------------------------|----|
| Create Your Style        | 52 |
| Step Lighting            | 53 |
| Oblong                   | 53 |
| Round and Square         | 54 |
| Strip Lighting           | 55 |
| Livewell Lamps           | 56 |
| Multi-flash Signal Lamps | 57 |

## Accessories

|                           |    |
|---------------------------|----|
| Submersible Trailer Lamps | 59 |
| Fans                      | 59 |
| Battery Master Switches   | 60 |
| Voltage Sensitive Relay   | 61 |
| 2 Group Dimmer            | 62 |
| Switches                  | 63 |
| Plugs & Sockets           | 64 |

---

## Quick Reference

|                      |    |
|----------------------|----|
| Technical Advantages | 65 |
|----------------------|----|

## Warranty

|                             |    |
|-----------------------------|----|
| Standing Behind our Product | 66 |
|-----------------------------|----|

# HELLA MARINE

## LIGHTING EXCELLENCE ASSURED

Hella marine is a leading brand of high performance lighting products that excel in harsh environments. The product range is manufactured in various global locations, with the majority coming from our world class facility in New Zealand.

With a rich heritage spanning over a century, and more than 3 decades of experience with LEDs, Hella marine has always been consistently committed to the design and manufacturing of high-quality lighting products. The company has witnessed a significant expansion over the past five decades, owed to the adoption of modern production methods and substantial investments in pioneering lighting technology.

In light of New Zealand's prolific maritime history and world-class yacht manufacturing prowess, HELLA New Zealand was designated as the global headquarters for Hella marine in 2004. The NaviLED lamp series elevated our status as pioneers in marine navigation lighting.

One of our earliest accomplishments includes being the first company globally to secure the European 'BSH\*' compliance for a navigation light using LEDs, in the form of the NaviLED PRO series. This approach to ongoing design and development has positioned us as a trusted partner globally.

\* Bundesamt für Seeschifffahrt und Hydrographie



### HELLA TODAY

With Faurecia's successful bid and acquisition of HELLA globally, Forvia was born. The newly named Forvia is now the 7th largest Automotive supplier in the world. One vision, speaking with one voice, working as one team.



150,000 employees



40 Countries



300 distribution, manufacturing, R&D sites



Product available in over 70 countries



Our in-house product development team of skilled specialists and engineers are authorities in electronic and optical design.

Utilizing cutting-edge materials we create innovative products that are not only reliable but also energy-efficient: embodying excellence through performance and sustainability by integrating the latest LED technology.

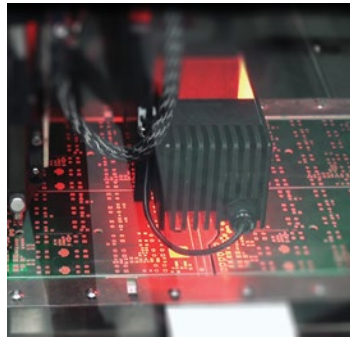

Our manufacturing premises are a testament to modern engineering with highly automated production capabilities.

Our electronics plant is equipped with the most recent automated, precision Surface Mount Technology (SMT) assembly systems, achieving self-sufficiency in Printed Circuit Board Assemblies (PCBAs) production in 2013. The plant places 53,000 LEDs daily, or 12.8 million LEDs per annum.



On-site testing facilities subject our products to cycles of extreme temperatures, intense UV light, chemical exposure, humidity, and salt-laden, corrosive conditions. Impact and vibration testing ensures that they perform under extreme stresses.

Our purpose built light tunnel ensures we meet all standards, and can guarantee quoted light output in all conditions.

EMC testing guarantees our products won't interfere with any sensitive radio or navigation equipment.



## LONG TERM SUSTAINABILITY

As a global company committed to sustainability and environmental protection, HELLA continues to accelerate its efforts against climate change and send a clear signal for climate protection. By 2025, all production sites worldwide are to manufacture in a CO<sub>2</sub>-neutral manner. Carbon neutrality is to be achieved through direct energy savings, the purchase of green electricity, aiming for a consistently climate-neutral supply chain by 2050 at the latest, and to supply customers worldwide with CO<sub>2</sub>-neutral products.

Hella marine is committed to playing an active role in protecting the environment, preventing pollution, minimizing waste, and avoiding adverse environmental impacts of our activities and products. We will achieve this by creating innovative, long lasting, energy efficient products, and applying operational excellence throughout the organization to ensure long term sustainability. Our Auckland, New Zealand factory today uses 100 per cent renewable energy, and 95 per cent of waste material generated during the moulding process is recycled. Hella marine invests in fully electric BEV and hybrid HEV vehicles in its fleet, and this number increases year on year.

# SYNCHRONISED VIBRANT COLOUR

## Apelo Light Controller

Transform your space into a stunning visual display, with unified control of all Apelo RGB/W Underwater, Interior, Flood, and Courtesy lamps; plus a selection of universal RGB products.

Effortlessly group and intelligently network multiple sets of lights and controllers wirelessly over Bluetooth® Mesh. Show your true colours with fully synchronised, completely customisable lighting throughout your vessel.



### Customisable Lighting

Easily create custom RGB/W lighting and animations, or switch between preset modes, combining convenience and creativity in every use.



### Bluetooth® Mesh Communication

Minimal wiring required for controller integration – the units communicate wirelessly over robust peer-to-peer Bluetooth® Mesh networking.



### Effortless Control

Seamlessly move between a multi-pole switch and the intuitive Apelo App to control your lighting.



### Synchronised Lighting

Synchronise light colours and groups throughout your vessel. Settings are distributed between and stored on connected controllers, so a constant Smartphone connection isn't required.



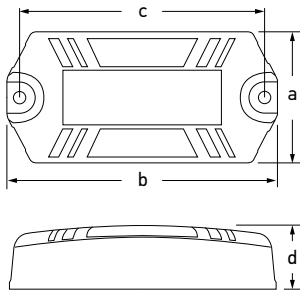

**Dimensions:**  
 a = 63mm (2.5")  
 b = 129mm (5.1")  
 c = 117mm (4.6")  
 d = 30mm (1.2")

## Apelo Light Controller

Elevate your lighting experience with the Hella marine Apelo Light Controller. Vibrant, dynamic, synchronised colours will transform your space into a stunning visual display.

Download the Apelo App and pair Apelo RGB Step lamps, Apelo EuroLED 75 RGB/W Downlights, and Apelo Underwater Lights to enhance your lighting experience. The Apelo Light Controller App lets you personalise your lighting configuration with ease.

### Customisable Lighting

Personalise your lighting with the Apelo Light Controller App and unlock endless colour possibilities. Easily create custom lighting or switch between preset modes, combining convenience and creativity in every use.

### Effortless Control

Seamlessly move between a multi-pole switch and the intuitive Apelo App to control your lighting. Bluetooth mesh technology allows seamless integration of multiple devices without having to connect them together.

### Mesh Communication

No wiring required for controller integration – the units communicate wirelessly. Once paired, instructions are seamlessly transmitted between controllers via over-the-air communication.

| Description              | Part Number   |
|--------------------------|---|
| Apelo Light Controller   | 5XA 285 814-001   |
| <i>Packaging</i>         | <i>Retail Carton for Single Pack</i>  |
| <b>Operating Voltage</b> | Multivolt™ 12 / 24V DC Nominal  |
| <b>Power Handling</b>    | 150W (13A @ 12V DC / 6.5A @ 24V DC)<br>(3A Per channel)   |
| <b>Power Consumption</b> | 1W  |
| <b>Connectivity</b>      | iOS / Android App over Bluetooth<br>13A Max High Side 3A Max Low Side<br>Direct Switch Control to toggle functions<br>(1 switch can control multiple devices) |
| <b>Communication</b>     | Bluetooth Low Energy (BLE) Mesh   |
| <b>Protection</b>        | IP67 (Completely sealed)  |
| <b>Cable</b>             | 140mm tinned marine cable   |
| <b>Base Material</b>     | V0 Rated Plastic  |
| <b>Compliance</b>        | FC CE UKA B   |



12V  
24V

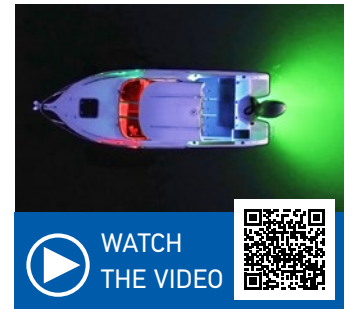

Scan or Click  
for more info

## Apelo Light Controller App

Pair the Apelo App with the Apelo Light Controller for infinite creativity and control of all compatible connected RGB/W lighting. Use the intuitive Apelo App to easily manage multiple controllers and light groups, access built-in presets, and express yourself with vivid colours and vibrant custom lighting sequences throughout your craft.

### No Phone? No Worries...

Directly wired Switch control allows for simple cycling through colour modes; press and hold, and the lights will dim or brighten. Switch control can be used alongside the Apelo Light Controller and Apelo App.

### Control more than just RGB

Apelo Light Controller is also able to manage single colour, dual colour, dual function, and dual intensity lights such as EuroLED 75/95, dual intensity Sea Hawk XLR floodlights, and Sea Hawk Light bars.

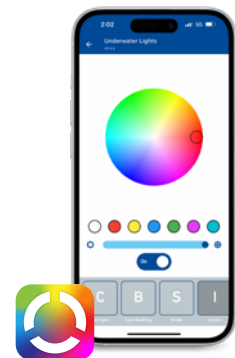

iPhone and App Store are registered trademarks of Apple Inc. Google Play is a registered trademark of Google Inc.

# APELO CONTROLLER BRINGS IT ALL TOGETHER

## Control

Connect Apelo Light Controllers to any combination of compatible Apelo RGB and RGB/W Underwater, Interior, Flood, and Courtesy lamps for individual and/or synchronised control. Easily adjust a single light or trigger a colour pattern throughout an entire grouping.

## Group

Use the intuitive Apelo App to easily group multiple lights and manage multiple controllers (individually, or groups containing multiple controllers and lights), to create areas of unique colours and functions throughout your vessel. All without additional wiring.

## Create

Make it as simple or as advanced as you like: from basic coloured mood and safety lighting, to a multi-colour, animating entertainment area synced with underwater lights, while also preserving the captain's night vision with red downlighting at the controls.

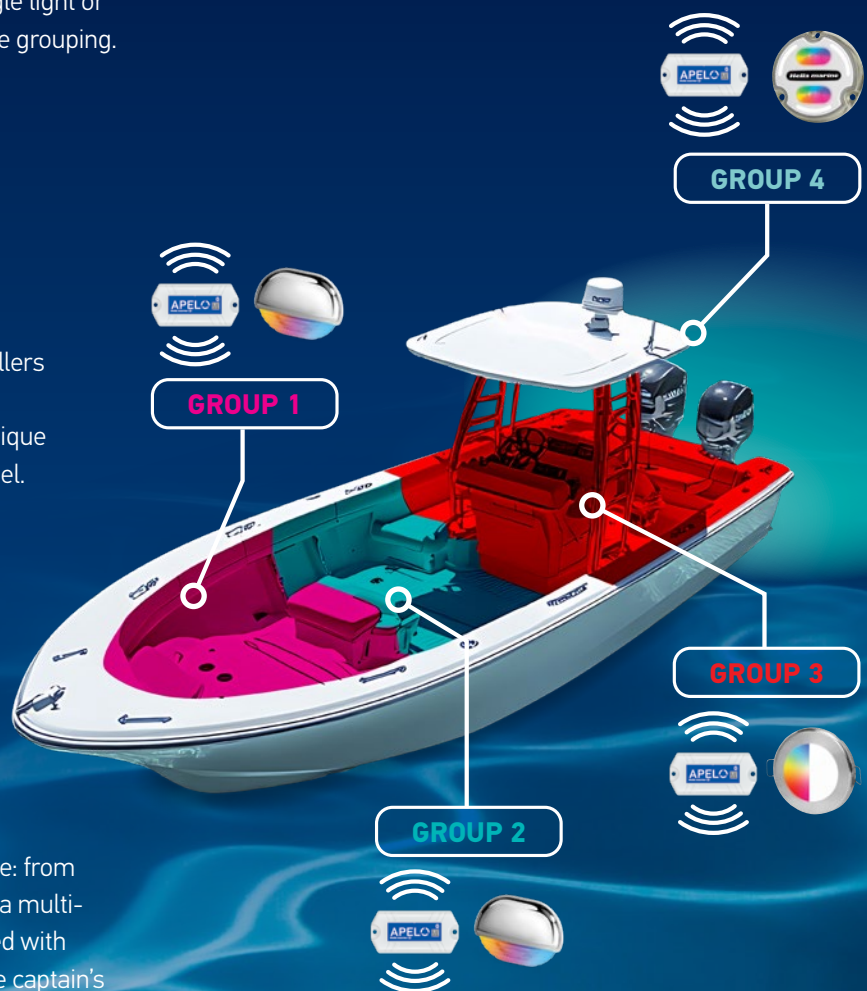

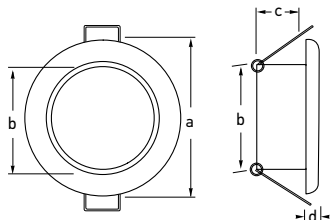

**Dimensions:**

- a = Ø75mm (3.0") Dia
- b = Ø54mm (2.2") Dia hole with spring clips
- Ø50mm (2.0") Dia hole for screw mount
- c = 21mm (0.9")
- d = 7.4mm (0.3")

\*May be Spring or Screw mounted.  
When screw mounting, remove springs and ensure mounting hole is only 50mm, versus 54mm for Spring mount.

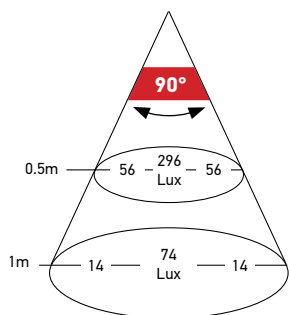

EuroLED 75 RGB/W

## Apelo EuroLED 75 RGB/W Downlight

A downlight with no compromise to form or function, the Apelo EuroLED 75 RGB/W delivers full spectrum colour, plus bright, even, broad illumination of 150 Lumens from dedicated White LED's. Whether you're setting the mood with vivid colours, or preserving your sensitive night vision with illuminating red, the Apelo EuroLED 75 RGB/W is a powerfully flexible lighting solution. Single and dual colour models also available.



| Function   | Trim   | Part Number     |
|--|--|-----------------|
| RGB/W  | White  | 2JA 017 884-001 |
| RGB/W  | Stainless  | 2JA 017 884-011 |
| <i>Packaging</i> Retail carton for single pack. PN shown in table above.<br>Trade Carton Pack 20pc multiple, replace final PN digit '1' with '7'.<br>DT Trade Carton Pack 18pc multiple, replace last 3 PN digits with '-207' (White Plastic) and '-217' (Stainless Steel) |  |                 |
| Mounting   | Recessed*  |                 |
| Cap Material   | White plastic, polished 316 stainless steel  |                 |
| Lens Material  | PC   |                 |
| Operating Voltage  | 12V DC only (9-16V)  |                 |
| Lumen Light Output   | 150 lumen measured output (White)  |                 |
| Power Consumption  | 3W RGB / 0.25A @ 12V DC<br>3W White / 0.25A @ 12V DC   |                 |
| Connectivity   | Flexible 6 wire connection.<br>Apelo Light Controller compatible   |                 |
| Protection   | IP6K7 & IP6K9K (Completely sealed):<br>Suitable for submersion in operation and high pressure water jet cleaning |                 |
| Cable length   | 120mm tinned marine cable  |                 |
| Connector (DT Models)  | 4 Pin + 2 Pin DT Connector   |                 |
| Compliance   | CE UK CA   |                 |



Scan or Click for more info

## Apelo RGB Step Lamp

Apelo RGB Step lamps offer a vibrant way to highlight and accent your steps and gangways. Dynamic, synchronised colours will transform your space into a stunning visual display. Apelo RGB Step Lamps use a simple, 4-wire connection for power and control. Labour saving installation via a 25mm hole. Available with chrome, white or stainless steel trim.

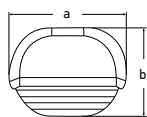
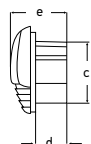

**Dimensions:**

- a = 45mm (1.77")
- b = 31.5mm (1.24")
- c = 25.4mm (1.00")
- d = 14mm (0.55")
- e = 22.7mm (0.89")

| Function  | Trim   | Part Number     |
|---|--|-----------------|
| RGB   | White  | 2JA 958 126-531 |
| RGB   | Chrome   | 2JA 958 126-541 |
| RGB   | Stainless  | 2JA 958 126-551 |
| <i>Packaging</i> Retail carton for single pack. PN shown in table above.<br>Trade Carton Pack 54pc multiple, replace final PN digit '1' with '7'.<br>DT Trade Carton Pack 54pc multiple, replace final 3 PN digits with '-507' (White Plastic), '-517' (Chrome), and '-527' (Stainless Steel) |  |                 |
| Mounting  | Recessed   |                 |
| Lens Material   | UV resistant enhanced impact acrylic                               |                 |
| Cap Material  | White plastic, chrome plated plastic, polished 316 stainless steel |                 |
| Operating Voltage   | Multivolt™ 12 / 24V DC Nominal                                     |                 |
| Power Consumption   | 1W / 0.03A (30 mA) MAX   |                 |
| Connectivity  | Simple 4 wire connection.<br>Apelo Light Controller compatible     |                 |
| Protection  | IP67 (Completely sealed)   |                 |
| Cable length  | 100mm tinned marine cable  |                 |
| Connector (DT Models)   | 4 pin DT Connector   |                 |
| Compliance  | CE UK CA   |                 |



Scan or Click for more info



# APELO

## Underwater Lights

Synchronised Vibrant Colour

As the sun sets, Apelo Underwater Lights come alive. Rich vibrant colour emblazes your transom, setting the scene for the night ahead. Whether entertaining, or attracting the next trophy catch, Apelo has it all.

Choose either vibrant blue or intense white transom lighting, or take control and set the stage with stunning full spectrum RGB colour at your fingertips.

Distinctive glowing signatures of Apelo's innovative Edge Light elegantly illuminates the border of the lamp front. The Edge Light functions in or out of the water and highlights the stern of the boat even when it's on the trailer.

Apelo Underwater Lights are made in New Zealand.



### Advanced materials

Apelo A1 uses a thermal polymer housing, a material completely resistant to corrosion and suitable for any hull material. Hella marine has employed thermal polymers for decades and built-up substantial experience. Thermal polymer draws heat away from the internal electronics to support the brightest polymer underwater lamps on the market.

### Electronic protection

Inside every Apelo lamp are intelligent drive circuits that sense their environment to regulate the power and control the heat inside. Apelo is as happy running out of the water as in it. We call this dry running protected.

### Sealing confidence

Robotic gluing delivers an incredible sealing accuracy of the glue mix and pinpoint placement batch after batch with near infinite repeatability. For confidence, Apelo is certified to IP68 and IP69.



## OPTICAL INTELLIGENCE FOR SUPERIOR BRIGHTNESS

Expert optical design delivers more light with a wide horizontal spread and a narrow vertical distribution for high lux levels where it counts instead of sending light too high or too low where it becomes invisible.

For the lumen rating on offer, Apelo competes with lamps offering higher lumen ratings using less energy to achieve the same intensity levels.

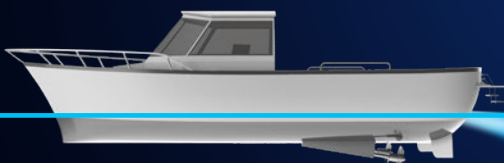

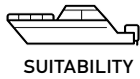

SUITABILITY

- FIBREGLASS
- TIMBER
- STEEL
- COMPOSITE
- ALUMINIUM



## Apelo A1 Underwater Light Polymer 1800 Lumen

The Apelo A1 is the most powerful light in its class, delivering vibrant blue or intense white, or full spectrum RGB\* colour experiences. All Apelo models use intelligent optical design to get impressive illumination levels that outshines the competition.

The A1 RGB\* light gives you complete control to choose any colour you wish, with Apelo's optical intelligence creating an even distribution of colour across the transom.

A completely sealed, corrosion resistant, thermal polymer housing ensures ongoing protection against the harshest environments. The A1 is suitable for mounting to any hull material. All Apelo models are equipped with an advanced thermal management system to allow operation in or out of the water.



White / Blue



RGB

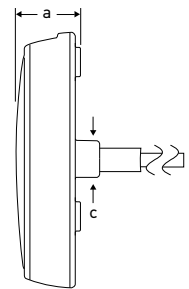
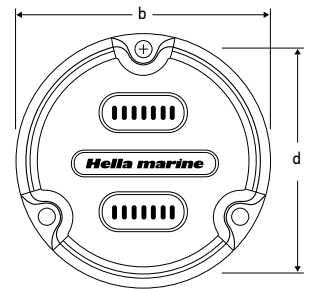

| Light Colour | White Lens      | Charcoal Lens   |
|--------------|-----------------|-----------------|
| White / Blue | 2LT 016 145-011 | 2LT 016 145-001 |
| RGB          | 2LT 016 146-011 | 2LT 016 146-001 |

*Packaging Retail carton for single pack. PN shown in table above  
Trade Carton Pack 4pc multiple, replace final PN digit '1' with '2'*

|                      |   |                                |
|----------------------|---|--------------------------------|
| Lumen                | 1800 (White)  |                                |
| Lens Material        | Grilamid® plastic, impact and UV resistant                      |                                |
| Housing Material     | Corrosion proof thermal polymer                                 |                                |
| Colour Temperature   | 5000K (White)   |                                |
| Cable                | 2.5m / 8.2ft, tinned marine cable                               |                                |
| Operating Voltage    | Multivolt™ 9-32V DC, 12 / 24V DC Nominal                        |                                |
| Power Consumption†   | Blue / White  | 20W (1.7A @ 12V / 0.9A @ 24V)  |
|                      | RGB   | 15W (1.25A @ 12V / 0.7A @ 24V) |
| Protection           | IP68 / IP69K  |                                |
| Weight (incl. cable) | White / Blue  | 250g                           |
|                      | RGB   | 300g                           |
| Compliance           | EN55015 / CISPR 15, IEC60533, IEC61547, ICES-005, CE, RCM, UKCA |                                |

\*Connect Apelo RGB lights to an RGB lighting controller for unlimited colour selection (Not supplied).  
† Allow up to 200% of power consumption to account for momentary peak.

### Dimensions:

a = 25.5mm (1.01")  
b = 95mm (3.74")  
c = 15.5mm (0.61") (Cable Hole)  
d = 83.5mm (3.29") (PCD)



Scan or Click  
for more info

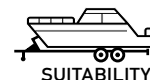

ALUMINIUM

## Apelo A2 Underwater Light Aluminium 3000 Lumen

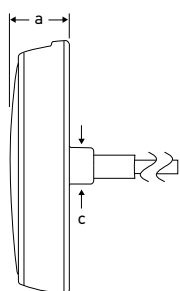
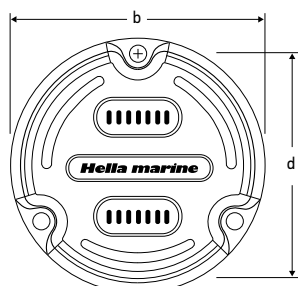

### Dimensions:

a = 23.5mm (0.92")  
b = 95mm (3.74")  
c = 15.5mm (0.61") (Cable Hole)  
d = 83.5mm (3.29") (PCD)

Boasting an incredibly bright 3000 lumen light output, the Apelo A2 offers not only more light, but more features. The Apelo A2 is available in either a vibrant blue or intense white combination, or full spectrum RGB\*. The additional stylish Edge Light illuminates your transom with distinctive glowing signatures bordering the lamp front. 'Fish mode' strobe function on the A2 Blue / White version is a sure fire way to attract attention, including from your next big catch.

Apelo A2's corrosion resistant, hard anodised, aluminium housing ensures even greater ongoing protection against the harshest environments. All Apelo Underwater Lights are completely sealed for total peace of mind. The A2's aluminium housing is tailored specifically for aluminium hulls which are not permanently submerged in salt water.

| Light Colour | Charcoal Lens   |
|--------------|-----------------|
| White / Blue | 2LT 016 147-001 |
| RGB          | 2LT 016 148-001 |

*Packaging Retail carton for single pack. PN shown in table above  
Trade Carton Pack 4pc multiple, replace final PN digit '1' with '2'*

|                      |   |
|----------------------|---|
| Lumen                | 3000 (White)  |
| Lens Material        | Grilamid® plastic, impact and UV resistant  |
| Housing Material     | Hard Anodised Aluminium   |
| Colour Temperature   | 5000K (White)   |
| Cable                | 2.5m / 8.2ft, tinned marine cable   |
| Operating Voltage    | Multivolt™ 9-32V DC, 12 / 24V DC Nominal  |
| Power Consumption†   | Blue / White 30W (2.5A @ 12V / 1.3A @ 24V)<br>RGB 30W (2.5A @ 12V / 1.3A @ 24V)<br>Edge Light <2W (<0.2A @ 12V / <0.1A @ 24V) |
| Protection           | IP68 / IP69K  |
| Weight (incl. cable) | White / Blue 310g RGB 360g  |
| Compliance           | EN55015 / CISPR 15, IEC60533, IEC61547, ICES-005, CE, RCM, UKCA   |

\*Connect Apelo RGB lights to an RGB lighting controller for unlimited colour selection (Not supplied).  
† Allow up to 200% of power consumption to account for momentary peak.



White / Blue



RGB



Scan or Click for more info



### Edge Light Technology

Apelo A2 and A3 models showcase Edge Light, distinctive glowing signatures of elegant illumination bordering the lamp front.



### Lightspeed™ Recommended

Hella marine recommends Lightspeed™ by Propspeed®, a foul-release coating to protect Apelo Underwater Lights and maintain their underwater brilliance. Lightspeed™ is tested to provide no decrease in light intensity, no colour shift and no other adverse performance decreases.



### Optical Intelligence

Apelo's precision optical distribution system projects light with spectacular effect. An asymmetrical, wide 90° horizontal spread and shallow 24° vertical beam height, means the light is able to efficiently spread further through the water.



### Dry Running Protected

Advanced thermal management ensuring ongoing protection and no damage by operation out of the water.

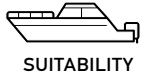

SUITABILITY

- FIBREGLASS
- TIMBER
- STEEL
- COMPOSITE



## Apelo A2 Underwater Light Bronze

### 3000 Lumen

The A2 Bronze stands out with its corrosion resistance properties, in addition to the Apelo A2 features of vibrant blue or intense white, or full spectrum RGB\* colour experiences, signature Edge Light, and strobe function.

A marine grade bronze housing delivers the ultimate in protection from harsh conditions, while offering superior durability and thermal management properties.

All the features and power of the A2 model in a no-compromise package makes this the preferred choice for permanent submersion. Suitable for fibreglass, timber, steel, and composite hulls (not aluminium).



White / Blue



RGB



Scan or Click for more info

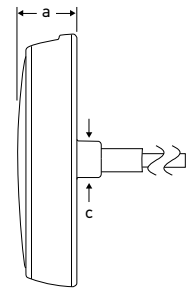
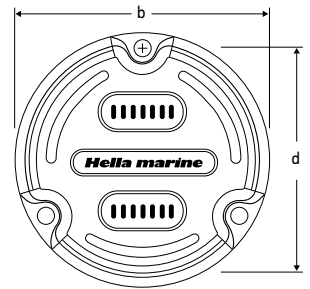

#### Dimensions:

- a = 23.5mm (0.92")
- b = 95mm (3.74")
- c = 15.5mm (0.61") (Cable Hole)
- d = 83.5mm (3.29") (PCD)

| Light Colour   | White Lens  |                                 |
|--|---|---------------------------------|
| White / Blue   | 2LT 016 147-101   |                                 |
| RGB  | 2LT 016 148-101   |                                 |
| <i>Packaging Retail carton for single pack. PN shown in table above</i>    |   |                                 |
| <i>Trade Carton Pack 4pc multiple, replace final PN digit '1' with '2'</i> |   |                                 |
| Lumen  | 3000 (White)  |                                 |
| Lens Material  | Grilamid® plastic, impact and UV resistant                      |                                 |
| Housing Material   | Marine grade bronze   |                                 |
| Colour Temperature   | 5000K (White)   |                                 |
| Cable  | 2.5m / 8.2ft, tinned marine cable                               |                                 |
| Operating Voltage  | Multivolt™ 9-32V DC, 12 / 24V DC Nominal                        |                                 |
| Power Consumption†   | Blue / White  | 30W (2.5A @ 12V / 1.3A @ 24V)   |
|  | RGB   | 30W (2.5A @ 12V / 1.3A @ 24V)   |
|  | Edge Light  | <2W (<0.2A @ 12V / <0.1A @ 24V) |
| Protection   | IP68 / IP69K  |                                 |
| Weight (incl. cable)   | White / Blue 600g   | RGB 650g                        |
| Compliance   | EN55015 / CISPR 15, IEC60533, IEC61547, ICES-005, CE, RCM, UKCA |                                 |

\*Connect Apelo RGBW lights to an RGBW lighting controller for unlimited colour selection (Not supplied).  
 † Allow up to 200% of power consumption to account for momentary peak.

## Apelo Surface Mount Spacer

### Underwater Light Mounting Accessory

The APELO surface mount spacer offers positioning flexibility and optimum cabling routing when mounting your APELO underwater lights. Rather than drilling holes into the transom, cable can be routed through the side to an above water position or somewhere that internal access is far more favourable.

The spacer features a 5 degree surface to allow for fine tuning the lighting direction: useful if you prefer the light to be directed out towards the side, or to avoid an obstruction, such as an outboard motor or trim tab, from blocking some of the light. This angle can also be used to offset a transom angle. Compatible with all APELO A1 and A2 models.

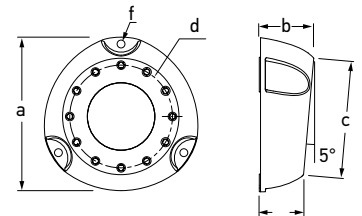

#### Dimensions:

- a = Ø125mm (4.93") Dia
- b = 45mm (1.78")
- c = Ø95mm (3.75") Dia
- d = Ø83.5mm (3.39") PCD
- e = 35mm (1.38")
- f = Ø5.5mm (0.22")

| Description  | Part Number     |
|--|-----------------|
| Surface Mount Spacer Underwater Light Mounting Accessory | 8HG 280 801-001 |
| <i>Packaging Trade Carton for Single Pack</i>            |                 |

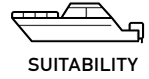

- FIBREGLASS
- TIMBER
- STEEL
- COMPOSITE

## Apelo A3 Underwater Light Bronze

### 6000 Lumen

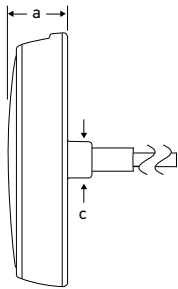
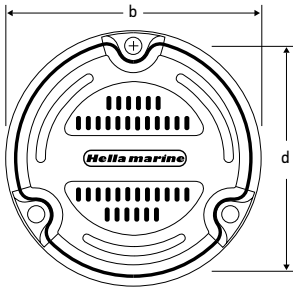

**Dimensions:**

- a = 23.5mm (0.92")
- b = 130mm (5.12")
- c = 15.5mm (0.61")
- d = 117.5mm (4.63") (PCD)

The ultimate in the Apelo Underwater Light range, and supercharged with 6000 lumen light output, and a larger overall size than the Apelo A2 Bronze. The A3 model has an improved formula with double the light output, maximizing the vibrant blue or intense white, or full spectrum RGB/W\* colour. The blue or white model retains the strobe functionality, while the RGB/W version includes dedicated white light emitting LEDs, adding brighter and more intense white light to your RGB underwater lighting. Both versions have Edge Light.

With the addition of Nickel-silver to the extremely corrosion resistant housing, the Apelo A3 is perfect for permanently submerged installations on larger boats and ships. Suitable for fibreglass, timber, steel, and composite hulls. Only mount on aluminium hulled vessels with a suitable isolation spacer.

| Light Colour         | White Lens   |
|----------------------|--|
| White / Blue         | 2LT 016 830-001  |
| RGB/W                | 2LT 016 831-001  |
| Packaging            | Retail Carton for Single Pack  |
| Lumen                | 6000 (White)   |
| Lens Material        | Grilamid® plastic, impact and UV resistant   |
| Housing Material     | Marine grade bronze  |
| Colour Temperature   | 5000K (White)  |
| Cable                | 2.5m / 8.2ft, tinned marine cable  |
| Operating Voltage    | Multivolt™ 9-32V DC, 12 / 24V DC Nominal   |
| Power Consumption†   | Blue / White 70W (5.9A @ 12V / 2.9A @ 24V)<br>RGB/W 70W (5.9A @ 12V / 2.9A @ 24V)<br>Edge Light <5W (0.37A @ 12V / 0.2A @ 24V) |
| Protection           | IP68 / IP69K   |
| Weight (incl. cable) | White / Blue 1020g RGBW 1080g  |
| Compliance           | EN55015 / CISPR 15, IEC60533, IEC61547, ICES-005, CE, RCM, UKCA  |



White / Blue



RGB/W

\*Connect Apelo RGB/W lights to an RGB/W lighting controller for unlimited colour selection (Not supplied).  
† Allow up to 200% of power consumption to account for momentary peak.



Scan or Click for more info





# Sea Hawk Light Bars

Sleek, Powerful & Ultra Durable

**When outstanding light intensity and proven reliability is needed to safely get you home, the Sea Hawk Light Bars are the preferred choice.**

These light bars are meticulously crafted using premium materials and construction techniques, guaranteeing their durability and appearance over an extended period of use.

Offering a range of beam patterns tailored to enhance night-time operations. Whether your priority is achieving the best distance-to-power ratio or achieving the widest light spread, you'll discover a Sea Hawk Light Bar that perfectly aligns with your specific requirements.

## Choosing the Right Light Pattern

A selection of Lux diagrams on page 19 show the distance the beam will travel down to 1lux, as well as the width of the beam at any given distance. You can generally consider half or a quarter of this distance as the usable range at which you need to see objects at night. As a general rule, we can classify this purpose into two main categories: close-range and long-range.



## Close Range Lighting

When you need to illuminate the local area, you can rely on the 'Spread' or 'Diffuse Flood' light bars. These light bars resemble traditional work lights in a 'bar' form, making them versatile for mounting options. You can opt for the conventional hard top mount for forward-facing illumination or choose to mount on the rear or sides to replace smaller-style work lamps.

## Long Range lighting

The Sea Hawk long range light bar family offers exceptional distance patterns called Spot or Pencil. These are typically unsuitable for immediate area illumination, so it is important to ensure you get the right pattern to suit your use case. These lights are typically used in front facing situations, mounted onto the hard top.

The Work Lamps section on page 22 also provides valuable insights for selecting the appropriate work lamp.

**Sea Hawk-470 Diffuse Flood:** Serves as an excellent immediate area floodlight. It is also a highly effective replacement for fluorescent lighting due to its wide and smooth light distribution.

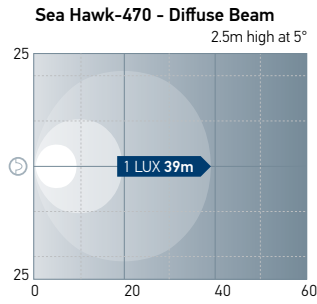

**Sea Hawk-470 Pencil Beam with Edge light:** Offers an impressive 1lux distance of 330 metres, a remarkable feat considering its low power consumption. This provides a substantial safety margin for detecting objects directly ahead, especially when navigating at high speeds in low-light conditions.

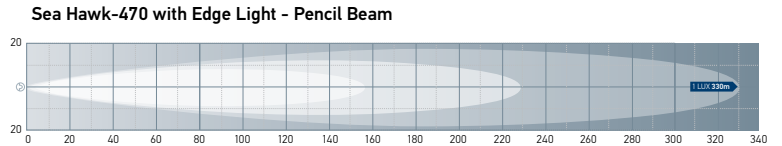

**Sea Hawk-470 Spot Beam:** This versatile light strikes a balance between wide and narrow illumination with its 30x30 degree beam. While it still provides a good reach, its beam width makes it particularly handy for slower navigation, through channels trying to pinpoint channel markers.

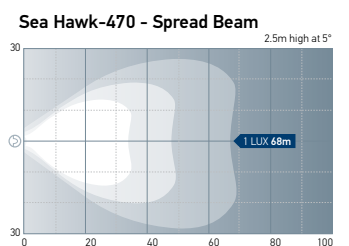
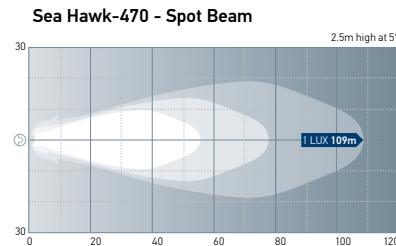

**Sea Hawk-470 Spread Beam:** Maintains the beam height at 30 degrees, but doubles the width to 60 degrees. The result is less centre punch, but much higher visibility to the sides. Great for operations such as manoeuvring through tight marina berths.

**Sea Hawk-350 Spot Beam:** A highly popular lamp that offers amazing distance for its compact size, the beam maintains width at medium distances making it a great all purpose choice.

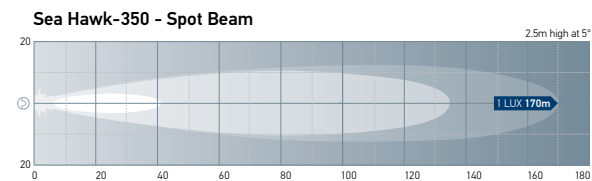

## MOUNTING LOCATION FOR SUPERIOR PERFORMANCE

Often overlooked, the mounting location is crucial to the application. Often times 'distance' beam light bars are mounted right at the lip of the hardtop, which causes reflections when turned on. These reflections draw the eyes to the bow and minimise the advantage of having the lights.

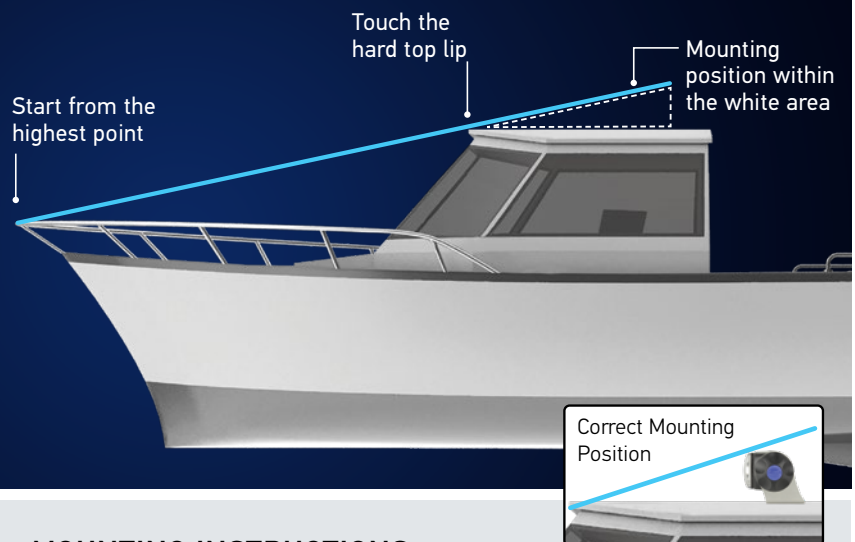

## MOUNTING INSTRUCTIONS:

- Make a string line off the highest point of the bow rail.
- Take this line over the roof, and lower it until it just touches the hard top lip.
- Note the height of the string as it moves further back on to the roof.
- This dotted triangle shown is the location for the light bar.
- Since light moves in straight lines, it is now impossible for the light to reflect and reduce visibility.



## Sea Hawk-470 Pencil Beam with Edge Light

The Sea Hawk-470 Pencil Beam with Edge Light combines long distance light performance capable of picking out even the most distant objects, and a striking Edge Light using light pipe technology.

Edge Light has been integrated into this powerful long distance light bar to give a distinctive glowing signature whilst also providing gentle ambient lighting. The Edge Light is available in both blue or white to give your vessel a unique appearance.

The unique corrosion proof housing provides exceptional durability and long-term reliability. The heavy duty Grilamid® lens offers an unbeatable combination of properties including toughness against impact, long term UV stability. Grilamid® will not lose its lustre or embrittle over time and will remain clear for the life of the product.



2LT 958 140-501



2LT 958 140-521



2LT 958 140-511



2LT 958 140-531

| Description                | Black Housing  | White Housing   |
|----------------------------|--|-----------------|
| White Edge Light           | 2LT 958 140-501  | 2LT 958 140-511 |
| Blue Edge Light            | 2LT 958 140-521  | 2LT 958 140-531 |
| Packaging                  | Trade Carton for Single Pack   |                 |
| Voltage                    | Multivolt™ 12/24V DC   |                 |
| Maximum Power Consumption  | Pencil Beam: 36W (2.7A @ 12V / 1.4A @ 24V)<br>Edge Light: 4W (300mA @ 12V / 150mA @ 24V)   |                 |
| Maximum Luminous Intensity | 113,000 candela  |                 |
| Light Performance          | 1 Lux @ 330m   |                 |
| Beam Angle                 | 8° x 4°  |                 |
| Protection                 | Reverse polarity and transient spike protection<br>IP6K7 (Protection against dust and temporary water immersion) IP6K9K (Protection against dust and high-pressure/steam jet cleaning) |                 |
| Cable                      | 2.5m of tinned multi-core marine cable   |                 |
| Body Material              | Corrosion proof thermal polymer  |                 |
| Lens Material              | Grilamid® plastic, impact and UV resistant   |                 |
| Compliance                 | CE, ECE R10, RCM, UKCA   |                 |



Note: Dimensions as Sea Hawk-470 on the opposite page

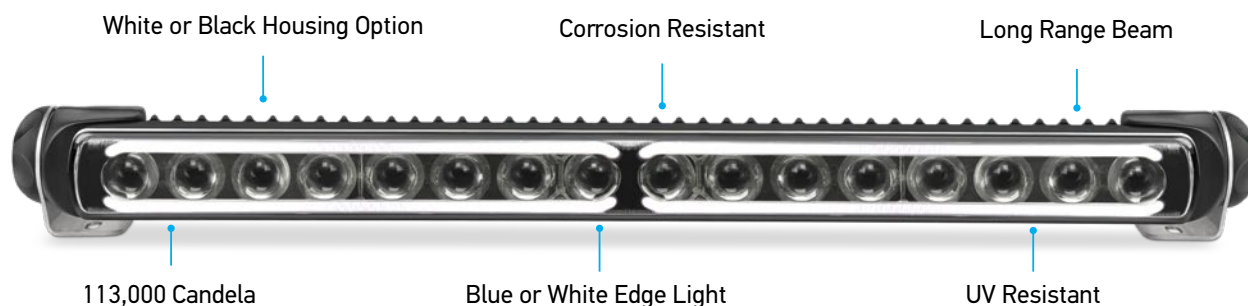

## ACCESSORIES

### Double Mounting Bracket

Optional double bracket enables multiple lamps to be stacked to increase the light output or spread of light.



| Description    | Part Number     |
|----------------|-----------------|
| Double Bracket | 8HG 958 128-811 |

## Sea Hawk-470 Light Bars

The sleek and powerful Sea Hawk-470 range features multiple lens options. Multivolt™ circuitry operating between 9 to 33V can be used with 12V or 24V DC supply.

A thermally conductive polymer housing, and the toughness of a UV, chemical and impact resistant Grilamid® lens, the Sea Hawk-470 is the natural choice when durability and long term reliability is needed.

| Lens Type        | Black Housing                       | White Housing   |
|------------------|-------------------------------------|-----------------|
| Spread           | 2LT 958 130-601                     | 2LT 958 130-611 |
| Spot             | 2LT 958 130-631                     | 2LT 958 130-641 |
| Diffused/Flood   | 2LT 958 130-501                     | 2LT 958 130-511 |
| Combi            | 2LT 958 130-441                     | 2LT 958 130-451 |
| <i>Packaging</i> | <i>Trade Carton for Single Pack</i> |                 |

|                   |  |
|-------------------|--|
| Voltage           | Multivolt™ 12 / 24V DC                     |
| Power Consumption | 35W (High) 4W (Low)                        |
| Lumen             | 3600 (Diffused) 2800 (Spot/Spread)         |
| Cable             | 2.5m of tinned multi-core marine cable     |
| Body Material     | Corrosion proof thermal polymer            |
| Lens Material     | Grilamid® plastic, impact and UV resistant |
| Compliance        | CE, ECE R10, RCM, UKCA                     |

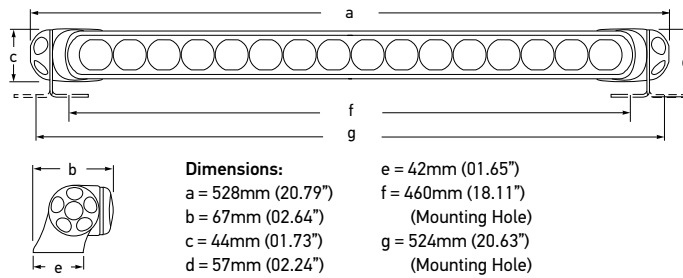

Spread Lens



Spot Lens



Diffused Lens



Combi Lens  
Spot with spread on the sides



## Sea Hawk-350 Light Bars

The Sea Hawk-350 floodlights generate over 2200 lumens of crisp, white light to illuminate the hardest to see places. Advanced electronics ensure constant and reliable light output and lamp protection even under severe voltage fluctuations and low battery voltages.

| Lens Type        | Black Housing                       | White Housing   |
|------------------|-------------------------------------|-----------------|
| Spread/Flood     | 2LT 958 040-701                     | 2LT 958 040-711 |
| Spot             | 2LT 958 040-651                     | 2LT 958 040-661 |
| Pencil           | 2LT 958 040-221                     | 2LT 958 040-231 |
| <i>Packaging</i> | <i>Trade Carton for Single Pack</i> |                 |

|                   |  |
|-------------------|--|
| Voltage           | Multivolt™ 12 / 24V DC                     |
| Power Consumption | 25W (High) 5W (Low)                        |
| Lumen             | 2200 (High)                                |
| Cable             | 2.5m of tinned multi-core marine cable     |
| Body Material     | Corrosion proof thermal polymer            |
| Lens Material     | Grilamid® plastic, impact and UV resistant |
| Compliance        | CE, ECE R10, RCM, UKCA                     |

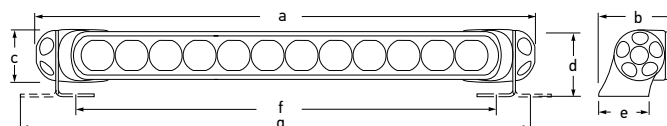

Spot Lens



Spread Lens



# Work Lamps

## Define How You Work

**Hella marine's extensive range of work lamps are designed to meet the needs of marine enthusiasts, professionals, and adventurers alike.**

We have a wide range of beam patterns that significantly enhance nighttime operations. Whether you're seeking compact, low-power draw solutions or the largest, most robust lamps designed for extreme environments, we have you covered. Professional sports fisherman, commercial operators, and ocean racers all recognize the 'non-glare' night vision preservation advantages of red lighting.

### Choosing the right lamp - Lux Level

The crucial element to selecting the right work lamp is to first determine the tasks required beneath this lighting. Low level ambient lighting for walkways might only require 25 lux, but where high accuracy work in the cockpit could be upwards of 3-500 lux. When considering lux calculations, it's essential to note that these values are cumulative, meaning that two lights with 100 lux each would result in a combined total of 200 lux.

### Area to be Lit

Measure the length and width of the area you require to be lit, but taking note of the area within the area where the work might be required. This will guide you as to whether the lux ratings are required right out to the edge of the area, or more in the middle.

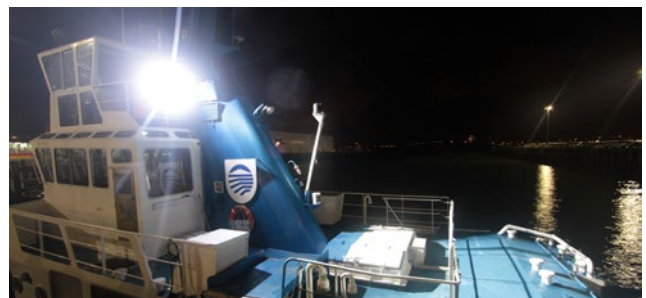

Red lighting is perfect for preserving your night vision.

### Lux Charts

Lighting lux charts give an idea as to how much lux each light will offer over what distance and width. Once you have all of the information, the lux charts should make a lot more sense. Feel free to reach out to your local agent if you need further assistance.



### Lighting Examples

Sea Hawk-XL Dual Colour LED Floodlights are ideal when changing between white light and coloured light is desired. Red is perfect for preserving your night vision, blue is popular to show off white gel coat, while warm white creates added comfort when you want to relax or match the rest of your interior lighting.

Sea Hawk-XLR LED Floodlights offer big lighting performance in a small size. The Spread pattern is perfect for lighting up cockpits of any size, while the Spot beam can be mounted much higher on a mast or spreader to light up a deck from directly above. Both lamps have a dual intensity mode for when only ambient lighting is required, or very low power draw is necessary.

FMS Deck Lamps are a great solution where only vertical mounting surfaces exist, and space is tight. Alternatively, these can mount upside down and out of the way in a corner, meaning head clearance is not impaired. These innovative lamps direct the light out and down at 45 degrees with no requirement for a bracket. Their spread beam pattern gives great coverage over a wide area.

### Mounting

The next consideration when selecting a work lamp is to assess the mounting environment. Various lamps provide different bracket options, that can be configured for upright or pendant mounting, offering maximum flexibility. Additionally, for more compact Sea Hawk lamps, there is the option of a recessed mount version if it aligns better with your specific application.

The specific mounting location will also dictate the height above the area to be lit, and this will affect the lux levels at the ground. If the mounting platform is high by necessity, then a narrow beam or spot lamp might be the most suitable, as this would 'throw' the light to where it needs to be.

### Dual Light Sources

One aspect that is frequently overlooked is the presence of objects that can obstruct the light, and more commonly, these objects are people. In such situations, having two lower-powered light sources positioned at opposite ends of the illuminated area proves far more practical than relying on a single source. This arrangement allows the light beams to intersect, significantly minimizing the potential for shadows to form.

Sea Hawk-XL Dual Colour - Spread

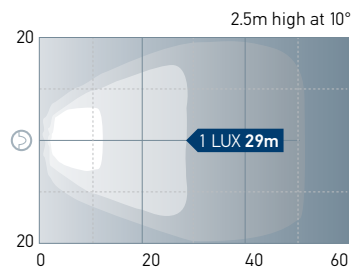

Sea Hawk-XLR - Spread

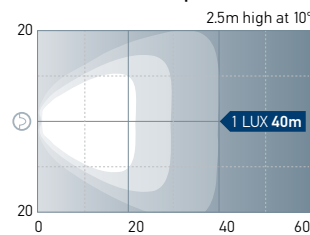

Sea Hawk-XLR - Spot

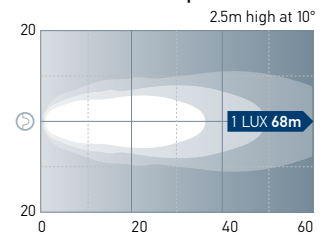

FMS1200

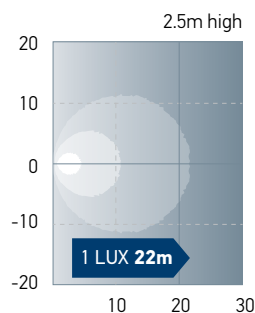

FMS2500

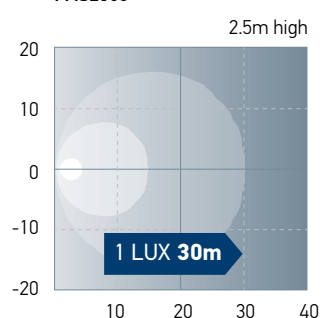



## Sea Hawk-XL Dual Colour LED Floodlights Spread Beam

Professional sports fisherman, commercial operators, and ocean racers all recognise the 'non-glare' night vision preservation advantages of red lighting. Two rows of bright white light is ideal when working, docking or landing the big one while the third row of secondary colour adds versatility. Red is perfect for preserving your night vision, blue is popular when a point of difference is needed, while warm white creates added comfort when you want to relax or match the rest of your interior lighting.

A heavy duty Grilamid® lens provides exceptional impact resistance. The unique ceramic thermal polymer housing distributes heat away from internal components and avoids potential corrosion issues associated with metal housings.



| LED Colours        | Housing Colour | Part Number     |
|--------------------|----------------|-----------------|
| White / Red        | Black Housing  | 2LT 980 950-041 |
| White / Red        | White Housing  | 2LT 980 950-051 |
| White / Blue       | Black Housing  | 2LT 980 950-061 |
| White / Blue       | White Housing  | 2LT 980 950-071 |
| White / Warm White | Black Housing  | 2LT 980 950-081 |
| White / Warm White | White Housing  | 2LT 980 950-091 |

*Packaging* Retail blister for single pack. PN shown in table above  
Trade Carton Pack 18pc multiple, replace final PN digit '1' with '7'

|                    |   |
|--------------------|---|
| Housing Material   | Corrosion proof thermal polymer                                       |
| Lens Material      | Grilamid® plastic, impact and UV resistant                            |
| Bracket Material   | 316 Stainless Steel   |
| Lumen              | 750 lumen   |
| Colour Temperature | 5000K (White), 2700K (Warm White)                                     |
| Operating Voltage  | Multivolt™ 12 / 24V DC  |
| Power Consumption  | 12W - White LEDs, 4W - Warm White LEDs, 4W - Blue LEDs, 2W - Red LEDs |
| Cable              | 2.5m tinned marine cable  |
| Protection         | IP67 (Completely sealed)  |
| Compliance         | CE, RCM, UKCA   |

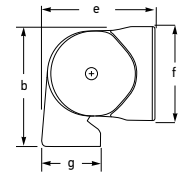
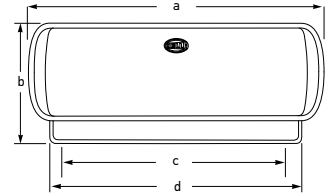

### Dimensions

a = 170mm / 6.69" e = 58mm / 2.28"  
b = 68mm / 2.68" f = 55mm / 2.17"  
c = 120mm / 4.72" g = 30mm / 1.18"  
d = 154mm / 6.06"

Note: Dimensions for Sea Hawk-XL Dual Colour and Sea Hawk-XLR.



### Beam Pattern Dual Colour - Spread

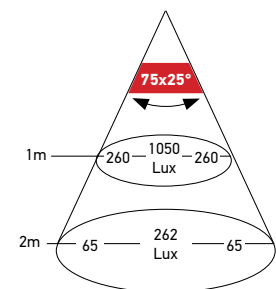
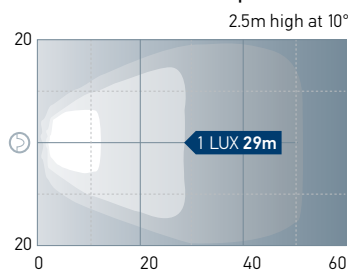

Sea Hawk Dual Colour

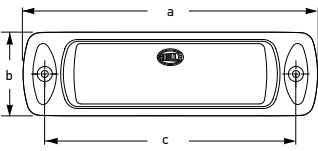

**Dimensions**

- a = 175mm / 6.90"
- b = 49mm / 1.93"
- c = 150mm / 5.91"
- d = 35mm / 1.38"
- e = 42mm / 1.65"
- f = 12mm / 0.47"

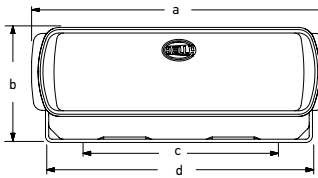
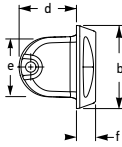

**Dimensions**

- a = 136mm (5.35")
- b = 53mm (2.08")
- c = 90mm (3.54")
- d = 123mm (4.85")
- e = 52mm (2.04")
- f = 42.0mm (1.66")
- g = 25mm (0.99")

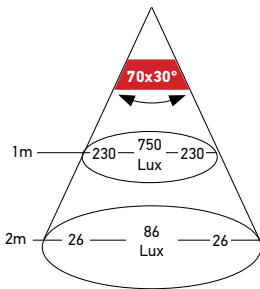
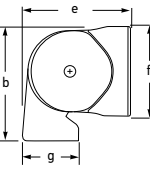

Sea Hawk-R Recess & Bracket Mount Spread

## Sea Hawk-R LED Floodlights

### Recessed / Bracket Mount

Sea Hawk-R housings are 'Non-metal', precision injection moulded from thermally conductive ceramic polymer that is highly resistant to degradation, even under harsh UV. Effectively transferring heat away from internal electronics to external surfaces for reliable long-term operation.

The Sea Hawk-R offers 550 lumens for only 7W of consumption. The engineered optical system illuminates with a wide, close-range spread over cockpits, foredecks or working areas on commercial and recreational vessels. Mounting options include a Stainless Steel bracket for mounting upright or as a pendant, or mount it recessed where desired.



#### Recess Mount

| Lens Type | Black Housing   | White Housing   |
|-----------|-----------------|-----------------|
| Spread    | 2LT 980 577-001 | 2LT 980 577-011 |

#### Bracket Mount

| Light Colour | Black Housing    | White Housing    |
|--------------|------------------|------------------|
| White        | 2LT 980 573-011* | 2LT 980 573-021* |
| Warm White   | 2LT 980 573-051  | 2LT 980 573-061  |

\*Packaging Retail blister for single pack. PN shown in table above  
Trade Carton Pack 18pc multiple, replace final PN digit '1' with '7'

|                       |  |
|-----------------------|--|
| Housing Material      | Corrosion proof thermal polymer  |
| Lens Material         | Grilamid® plastic, impact and UV resistant                             |
| Bracket (0573 Series) | 316 stainless steel  |
| Lumen                 | 550 lumen  |
| Colour Temperature    | 5000K (White) / 3000K (Warm White)                                     |
| Operating Voltage     | Multivolt™ 12 / 24V DC   |
| Power Consumption     | 7W (0.58A @ 12V / 0.29A @ 24V)   |
| Cable                 | Recess: 500mm tinned marine cable<br>Bracket: 2.5m tinned marine cable |
| Protection            | IP67 (Completely Sealed)   |
| Compliance            | CE, RCM, UKCA  |



## Sea Hawk-XLR LED Floodlights

1500 lumens of crisp, white, darkness-busting illumination with the proven Sea Hawk-XLR. Housings are precision injection moulded from thermally conductive ceramic polymer. This advanced material draws heat from internal electronics for reliable long-term operation and eliminates the need for an aluminium housing in this class of floodlight, removing corrosion risks in the harsh marine environment.

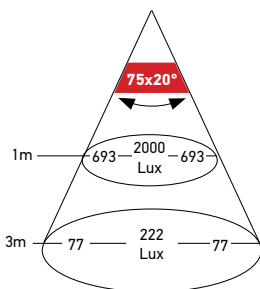

Sea Hawk-XLR

Note: Dimensions same as Sea Hawk-XL  
Dual Colour.

| Lens Type | Black Housing    | White Housing    |
|-----------|------------------|------------------|
| Spread    | 2LT 980 740-001* | 2LT 980 740-011* |
| Spot      | 2LT 980 740-201  | 2LT 980 740-211* |

\*Packaging Retail blister for single pack. PN shown in table above  
Trade Carton Pack 18pc multiple, replace final PN digit '1' with '7'

|                    |  |
|--------------------|--|
| Housing Material   | Corrosion proof thermal polymer            |
| Lens Material      | Grilamid® plastic, impact and UV resistant |
| Bracket Material   | 316 Stainless Steel                        |
| Lumen              | 1500 lumen                                 |
| Colour Temperature | 5000K                                      |
| Operating Voltage  | Multivolt™ 12 / 24V DC                     |
| Power Consumption  | 18W (High) 2W (Low)                        |
| Cable              | 2.5m tinned marine cable                   |
| Protection         | IP67 (Completely Sealed)                   |
| Compliance         | CE, RCM, UKCA                              |





## FMS Deck Lamps

Hella marine introduces the low profile and powerful FMS LED deck lamps. These surface mount scene lamps are purpose designed to integrate discretely into tight spaces and exterior recesses, yet throw a huge amount of light wherever they are installed. With a protrusion of only 38mm, the FMS lamps are sleek and unobtrusive during the day, but make themselves very well-known at night!

Two light intensities are offered: the FMS1200 with 1200 lumens; and the FMS2500 with an even more powerful 2500 lumens. Both lamps offer even, close-range illumination directly underneath the lamp. The light is projected downwards at a fixed angle of 45 degrees, no brackets to adjust.

Energy efficient, completely sealed, shock and vibration resistant lighting. Advanced electronics provide consistent illumination and circuit protection across a range of inputs from 12/24V DC for an ultra-long service life.



| Lamp Type | Black Housing                | White Housing   |
|-----------|------------------------------|-----------------|
| FMS1200   | 1GB 996 098-001              | 1GB 996 098-501 |
| FMS2500   | 1GB 996 098-011              | 1GB 996 098-511 |
| Packaging | Trade carton for single pack |                 |

|                    |  |
|--------------------|--|
| Housing Material   | Die-cast aluminium, CoroSafe coating   |
| Mounting           | Surface mount  |
| Lumen              | FMS1200: 1200 lumen<br>FMS2500: 2500 lumen   |
| Colour Temperature | 6500K  |
| Operating Voltage  | Multivolt™ 12 / 24V DC   |
| Power Consumption  | FMS1200: 14W (1.17A @ 12V DC / 0.58A @ 24V DC)<br>FMS2500: 28W (2.33A @ 12V DC / 1.17A @ 24V DC) |
| Cable              | 500mm of twin core cable   |
| Protection         | IP6K9K, IP6K8  |
| Compliance         | ECE R10, RCM, ADR / GGVSEB, UKCA   |

FMS1200 Light Distribution

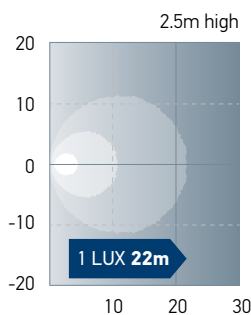

FMS2500 Light Distribution

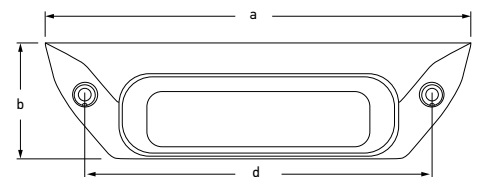
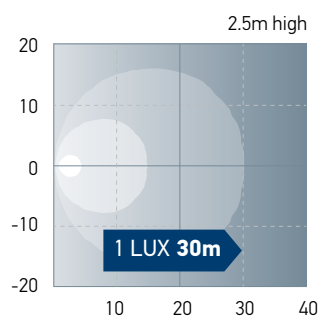

**Dimensions**

- a = 243mm (9.57")
- b = 66mm (2.59")
- c = 38mm (1.49")
- d = 134mm (5.27")

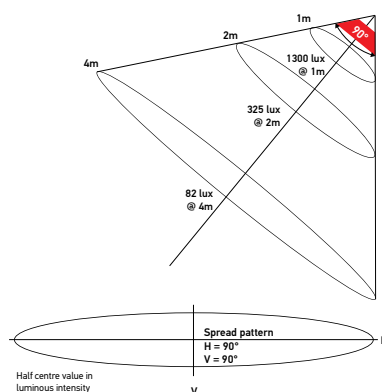
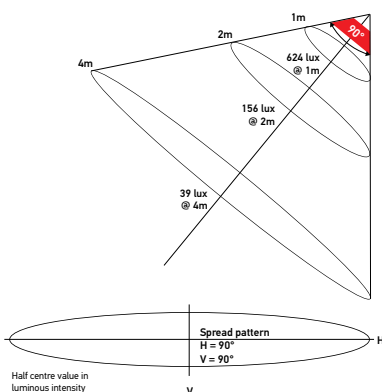
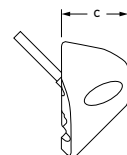

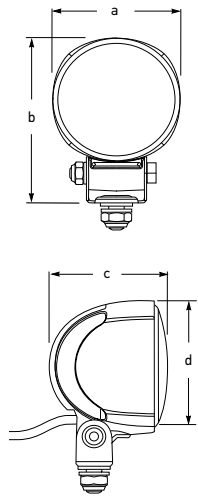

**Dimensions**

a = 83mm (3.27")  
 b = 110mm (4.33")  
 c = 74mm (2.91")  
 d = 83mm (3.27")

## Module 70 Gen 5

The Module 70 PRO offers 3500 lumen, more than enough to light up your average cockpit. A pair will provide significant lighting in a larger area, if needed.



### Module 70 Gen 5

| Lens Type   | Black Housing                  | White Housing   |
|-------------|--------------------------------|-----------------|
| Close Range | 1G0 996 476-211                | 1G0 996 476-191 |
| Long Range  | 1G0 996 476-221                | 1G0 996 476-201 |
| Packaging   | Retail blister for single pack |                 |

|                    |   |
|--------------------|---|
| Housing Material   | Aluminium, CoroSafe coating. Glass lens<br>Bracket: Stainless Steel |
| Lumen              | 3500 lumen  |
| Colour Temperature | 6500K   |
| Operating Voltage  | Multivolt™ 12 / 24V DC  |
| Power Consumption  | 29W (2.4A @ 12V DC / 1.2A @ 24V DC)                                 |
| Cable              | 1m tinned marine cable  |
| Protection         | IP6K9K (Completely sealed)  |



1G0 996 476-211  
M70 Gen 5 Close Range

1G0 996 476-221  
M70 Gen 5 Long Range



1G0 996 476-191  
M70 Gen 5 Close Range

1G0 996 476-201  
M70 Gen 5 Long Range

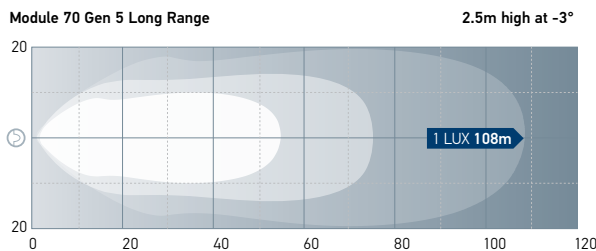
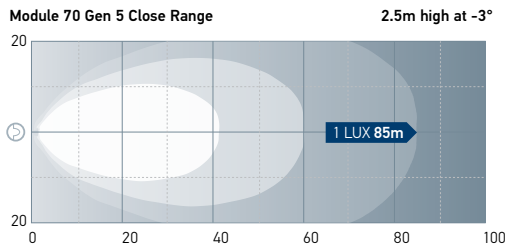



## RokLUME 155 TP

The RokLUME 155 TP is a robust worklight in a universal, attractive design, and delivers 1200 lumen of light output in either close or long range beam options. Suitable for personal and commercial marine applications, the impact resistant lens and corrosion resistant Thermal Polymer housing ensure a long life in any environment.



Close Range

| Lens Type          | Part Number  |
|--------------------|--|
| Close Range        | 1GA 996 284-051  |
| Long Range         | 1GA 996 284-061  |
| Packaging          | Trade Carton for single pack   |
| Housing Material   | Thermally conductive polymer   |
| Bracket Material   | Heavy Duty nylon bracket   |
| Lumen              | 1200 lumen   |
| Colour Temperature | 5000K (Daylight White)   |
| Power Consumption  | 15W  |
| Operating Voltage  | Multivolt™ 9-33V DC  |
| Cable              | 200 mm with DT socket (Optional 2.0 metre DT Pigtail Loom to be ordered separately)  |
| Protection         | Reverse polarity and voltage spike protection<br>IP6K7 & IP6K9K - (Protection against dust, prolonged water immersion and high-pressure / steam) |
| Compliance         | ECE R10, RCM   |
| Spare Part         | 9.1551LED.06 DT Pigtail Loom, 2 metres   |

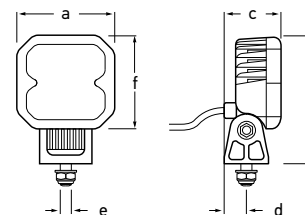

### Dimensions:

a = 95mm (3.74")  
 b = 144mm (5.67")  
 c = 57mm (2.24")  
 d = 23mm (0.90")  
 e = 10mm (0.39")  
 f = 90mm (3.54")

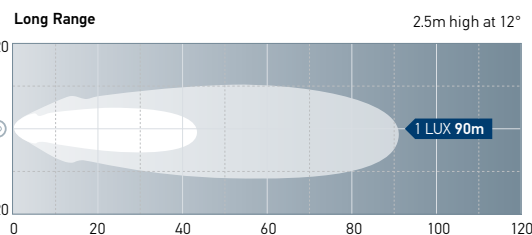
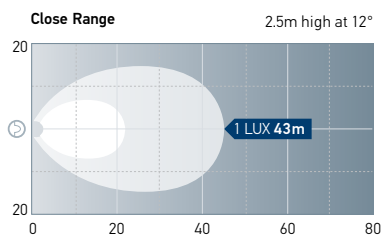

## RokLUME 380 Heavy Duty 24V Floodlight

RokLUME 380 floodlights offer incredible performance and durability in the harshest conditions for hard working vessels. delivering 7500 lumen of light output in either close or long range beam options. Purpose designed for commercial marine applications, the impact resistant, hard-coated polycarbonate lens and premium corrosion-resistant aluminium housing ensure a long life.

The heavy duty stainless steel bracket features Nord-Lock washers and a rubber damping system to limit movement on high vibration vessels. The advanced optic systems provide powerful forward facing lighting.

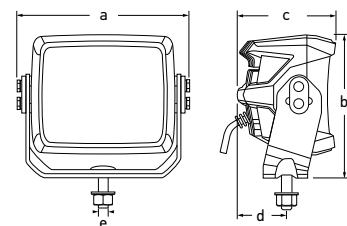

### Dimensions:

a = 179mm (7.05")  
 b = 148mm (5.80")  
 c = 102mm (4.01")  
 d = 51mm (2.0")  
 e = 10mm (0.39")



Long Range

| Lens Type          | Part Number  |
|--------------------|--|
| Close Range        | 1GA 996 197-011  |
| Long Range         | 1GA 996 197-021  |
| Packaging          | Trade Carton for single pack   |
| Housing Material   | Premium aluminium with NanoSafe non-stick coating  |
| Bracket Material   | Heavy Duty Stainless Steel   |
| Lumen              | 7500 lumen   |
| Colour Temperature | 5000K  |
| Power Consumption  | 84W  |
| Operating Voltage  | 20V-32V DC (Nominal 24V)   |
| Cable              | 2.0m double insulated silicone supply cable with bare ends   |
| Protection         | Reverse polarity and voltage spike protection<br>IP6K8 & IP6K9K - (Protection against dust and high-pressure/steam jet cleaning) |
| Compliance         | CE, ECE R10, RCM, CISPR 25 CLASS 4, UKCA   |

**RokLUME 380**  
 Heavy Duty Floodlights

WATCH THE VIDEO



# HypaLUME Floodlighting

A quantum technology leap for commercial vessels, HypaLUME is Hella marine's most powerful floodlight. Designed for applications where high output lighting in extreme environments are required. Comprehensive sealing and anti-corrosion measures have been taken to ensure the lamps withstand the toughest conditions. The premium aluminium housing is corrosion resistant with a non-stick and easy to clean surface coating.

A heavy duty Grilamid® lens offers unbeatable toughness against impacts and vibration while providing long term UV stability and resistance to commonly used chemicals for the life of the product. The HypaLUME is designed to operate over an extreme temperature range from -40°C to +50°C. The advanced thermal management draws heat away from the LEDs to maintain a long service life.

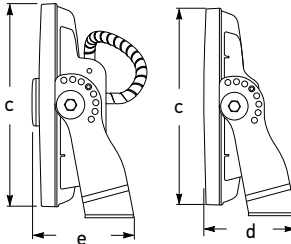
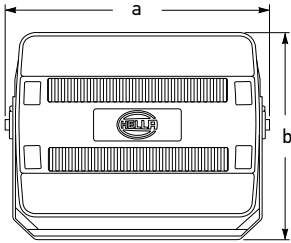

AC

DC

### Dimensions

110 / 230V AC

24 / 48V DC

a = 520mm (20.47")

a = 520mm (20.47")

b = 380mm (15.9")

b = 380mm (15.9")

c = 359mm (14.13")

c = 359mm (14.13")

e = 180mm (7.08")

d = 166mm (6.54")

## 110 / 230V AC LED Floodlights

| Lens Type         | Part Number  |
|-------------------|--|
| Close Range       | 1GJ 958 334-011  |
| Long Range        | 1GJ 958 334-021  |
| Extra Wide        | 1GJ 958 334-031  |
| Packaging         | Trade Carton for single pack   |
| Operating Voltage | 100 to 240V AC   |
| Power Consumption | 300W   |
| Lumen             | 28000 lumen  |
| Connection        | Wieland RST Mini - 16A   |
| Cable             | Supplied with 2.0m of easy plug-in sheathed cable  |
| Protection        | IP66 and IP67 (Protection against dust and high pressure water jets and temporary water immersion) Over-temperature protection |
| Compliance        | CE, RCM, FCC, AS/NZS 60598.2.5, UKCA   |



Close Range Lens



Long Range Lens



Extra Wide Lens

## 24 / 48V DC LED Floodlights

| Lens Type         | Part Number   |
|-------------------|---|
| Close Range       | HMF2000CMOB (1GJ 011 872-501)   |
| Long Range        | HMF2000LMOB (1GJ 011 872-511)   |
| Extra Wide        | HMF2000WMOB (1GJ 011 872-521)   |
| Packaging         | Trade Carton for single pack  |
| Operating Voltage | 22 to 52V DC  |
| Power Consumption | 260W  |
| Lumen             | 25000 lumen   |
| Connection        | 4 Pin Deutsch plug  |
| Cable             | Supplied with 1.8m of easy plug-in sheathed cable   |
| Protection        | IP6K9K (Fully sealed against dust and high-pressure / steam jet cleaning)<br>Advanced thermal management. Reverse polarity, transient spike and over voltage protection |
| Compliance        | CE, RCM, FCC, ISO 13766, ECE R10, UKCA  |



Wieland RST Mini Connection



DT connection



WATCH THE VIDEO



Extra Wide 1GJ 958 334-031

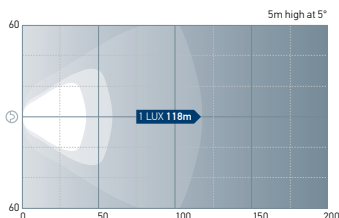

Close Range 1GJ 958 334-011

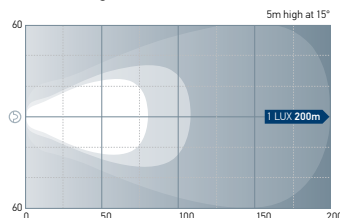

Long Range 1GJ 958 334-021

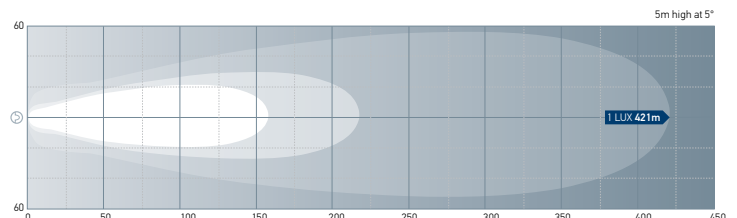



## LED Hand Held Search Light

Hella marine hand held search lights are vital tools for night sailing and essential for spotting looming obstacles from a safe distance, or dependable light in an emergency. Integrated trigger switch and handle allows for Morse code signalling.

Rugged construction and a CoroSafe coating system is specifically designed for the harsh marine environments. Multivolt™ technology ensures reliable illumination and lamp protection even under severe voltage fluctuations and low battery conditions. Advanced electronics provide reverse polarity, spike and over-voltage protection for long life and reliable operation.

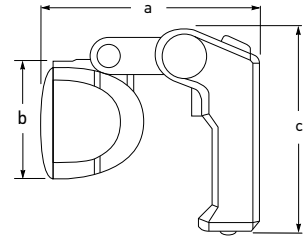

**Dimensions**  
 a = 160mm (6.30")  
 b = 83mm (3.30")  
 c = 145mm (5.71")

| Lens Type         | Black Housing                           |
|-------------------|---|
| Close Range       | 1HO 996 476-512                         |
| Long Range        | 1HO 996 476-502                         |
| Packaging         | Retail blister for single pack          |
| Housing Material  | Die-cast aluminium, CoroSafe coating    |
| Lumen             | 3500 lumen                              |
| Operating Voltage | Multivolt™ 12 / 24V DC                  |
| Cable             | Spiral cable with cigarette plug (3.5m) |
| Power Consumption | 29W (2.42 @ 12V DC / 1.21A @ 24V DC)    |
| Protection        | IP6K9K, IP6K8 (Completely sealed)       |

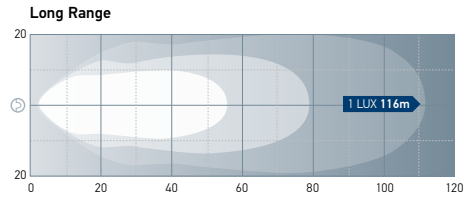
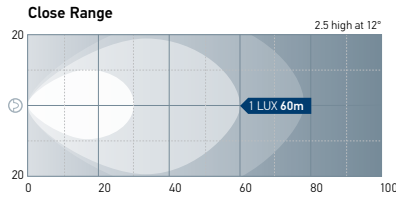

| Accessory       |                 |
|-----------------|-----------------|
| Deck Mount Base | 8HG 998 519-001 |

# WORLD LEADING MARINE LIGHTING

---



ENERGY EFFICIENT, RELIABLE & ULTRA DURABLE



# NaviLED Navigation Lights

## Setting The Standard

**Hella marine's NaviLED range are the leaders in the marine Navigation signal lighting industry, having established an enviable reputation for superior light control and reliability.**

Proven on the harshest waters worldwide, Hella marine LED Navigation Lamps provide power saving, highly visible and ultra durable lighting.

Navigation Lamps, often overlooked, are an essential component for any boat. Various rules dictate which lights are necessary for different types of vessels. For detailed information, refer to our Navigation Lamp Guide on page 34.

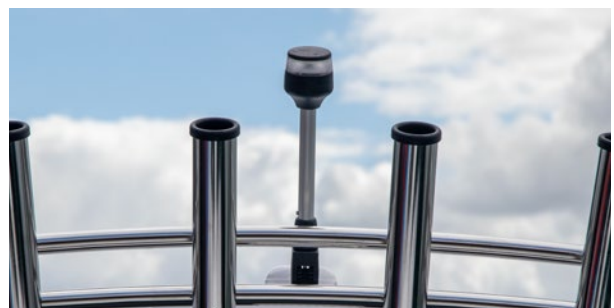

### **NaviLED, Superior Performance**

Advanced LED optics deliver optimal horizontal and vertical light distribution according to international standards. Cut-off angles are ultra precise, clearly indicating a vessel's movement and heading.

Each Hella marine LED lamp is a completely sealed opto-electronic device. Proven design, precision engineering, and the use of high impact acrylic materials ensures superior resistance to water, impact, UV and general wear and tear.

All our Navigation Lamps feature extra thick lenses. Taking ultra durable lighting to a new level, Hella marine specifies Grilamid®, a high performance polyamide as a standard or optional lens choice. Grilamid® is a revolutionary transparent plastic with an exceptionally high impact strength and resistance to UV and chemical damage.

Multivolt™ circuitry provides a uniform level of intensity for reliable and safe illumination across a range of DC inputs such as 9-33 volts. Multivolt™ LED lamps can be connected to 12 or 24 volt systems without modification, providing full light performance and automatic compensation for low battery voltages and voltage drop over long cables and connections. Multivolt™ LED lamps are also reverse polarity and spike protected for enhanced durability even under severe voltage fluctuations.

We design our products to suppress electromagnetic interference, complying with the emission and immunity limits prescribed in international standards. This protects the radio, communication, navigation and other electrical equipment onboard from possible interference with our products.

## Photometric Testing

NaviLED lamps are photometrically verified in our facility by a sophisticated goniometer to ensure compliance with the intensity and cut-off requirements of international navigation lamp standards.

After passing photometric testing and where required, a unique serial number is laser engraved onto the lens. This serial number is referenced to individual test reports which are electronically archived by Hella marine, ensuring international navigation lamp standards are consistently met.



## Navigation Lamp Approvals

Hella marine navigation lamps comply with the International Regulations for Prevention of Collisions at Sea (IMO COLREG 72). Refer to our Navigation Lamp Guide on page 34.

This IMO compliance, together with supplementary national or regional requirements, is listed with each navigation lamp series throughout the catalogue.

### Approval types:



Complies with IMO (International Maritime Organization) requirements under the International Regulations for the Prevention of Collisions at Sea. (IMO COLREG 72). IMO COLREG 72 forms the international basis for legal navigation lighting on vessels.



Complies with USCG (United States Coast Guard) requirements. Lamps carry a marking for minimum visible distance in nautical miles, e.g. USCG 2NM.



Approved under the Marine Equipment Directive (MED) 96/98/EC last modified by directive 2008/67/EC for use throughout Europe in all EC member states for both pleasure and commercial vessels.



Complies with ABYC (American Boat and Yacht Council) Navigation Lamp Standard C-5.



Suitable for vessels compliant with RCD (Recreational Crafts and Personal Watercraft Directive) 2013/53/EU. RCD promotes a single set of EU safety and technical requirements for new recreational vessels less than 24m in length within the European Community.



Approved for placement on UK ships. Carries the UK conformity mark for marine equipment, the 'Red Ensign'. Required from 1st January 2023.

### Certifying bodies:



Approved by the German BSH (Bundesamt für Seeschifffahrt und Hydrographie) and carry BSH type approval numbers. BSH was formerly called DHI (Deutsches Hydrographisches Institut).



Approved by the Italian RINA (Registro Italiano Navale) authority.

# IMO COLREG 72 Lights and Visibility - Powerboats

IMO COLREG requirements for navigation lighting on powerboats less than 50m (164ft) LOA (Length Overall).

Note - Sailboats under motor adopt the rules for Powerboats.

**Powerboats up to 7m (23ft).**  
Not capable of more than 7 knots

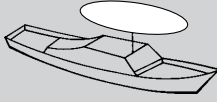

- 1x All Round White

**Powerboats up to 12m (39ft)**  
Where Separate Masthead and Stern cannot be mounted

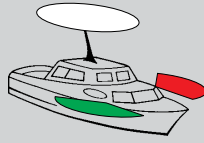

- 1x Port lamp (2NM)
- 1x Starboard lamp (2NM)
- OR
- 1x Bi-Colour lamp (2NM)
- 1x All Round White lamp (2NM)

**Powerboats up to 12m (39ft)**



- 1x Port lamp (2NM)
- 1x Starboard lamp (2NM)
- OR
- 1x Bi-Colour lamp (2NM)
- 1x Masthead lamp (2NM)
- 1x Stern lamp (2NM)

**Powerboats more than 12m (39ft), but less than 20m (65ft)**

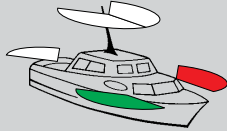

- 1x Port lamp (2NM)
- 1x Starboard lamp (2NM)
- OR
- 1x Bi-Colour lamp (2NM)
- 1x Masthead lamp (3NM)
- 1x Stern lamp (2NM)

**Powerboats more than 20m (65ft), but less than 50m (164ft)**

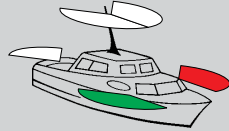

- 1x Port lamp (2NM)
- 1x Starboard lamp (2NM)
- 1x Masthead lamp (5NM)
- 1x Stern lamp (2NM)

The following images depict **ADDITIONAL** lighting requirements for specific activities:

**A vessel less than 50m (164ft) engaged in trawling**

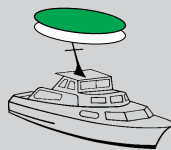

- 1x All Round Green lamp (2NM)
  - 1x All Round White lamp (2NM)
- Mounted above one another

**A vessel less than 50m (164ft) engaged in fishing, other than trawling**

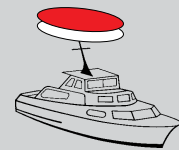

- 1x All Round Red lamp (2NM)
  - 1x All Round White lamp (2NM)
- Mounted above one another

**Powerboats towing with a tow length of less than 200m**

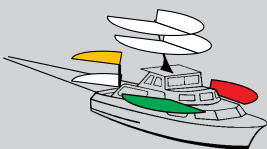

- 1x Towing lamp (2NM)
- Mounted above Stern lamp
- 2x Masthead lamps in a vertical line.
- (When the tow length exceeds 200m, 3x Masthead lamps in a vertical line)

**A vessel engaged in diving operations**



- 1x All Round Red lamp (2NM)
  - 1x All Round White lamp (2NM)
  - 1x All Round Red lamp (2NM)
- Mounted above one another

**A vessel engaged in pilotage duty**



- 1x All Round White lamp (2NM)
  - 1x All Round Red lamp (2NM)
- Mounted above one another

# IMO COLREG 72 Lights and Visibility - Sailboats

IMO COLREG requirements for navigation lighting on sailboats less than 50m (164ft) LOA (Length Overall).

Note - Sailboats under motor adopt the rules for Powerboats.

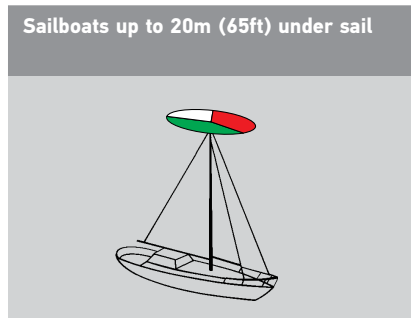

- 1x Tri-Colour lamp (2NM)

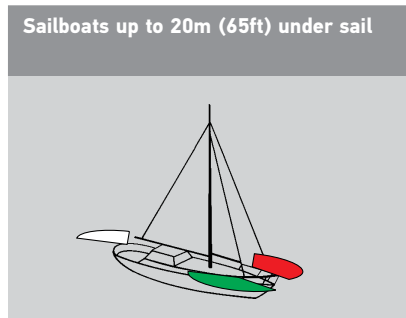

- 1x Port lamp (2NM)
- 1x Starboard lamp (2NM)
- OR
- 1x Bi-Colour lamp (2NM)
- 1x Stern lamp (2NM)

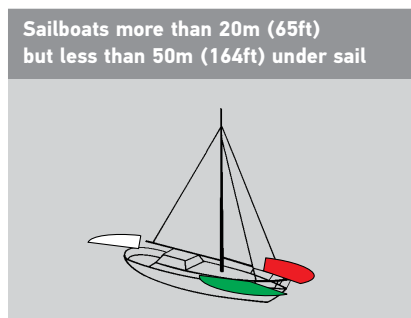

- 1x Port lamp (2NM)
- 1x Starboard lamp (2NM)
- 1x Stern lamp (2NM)

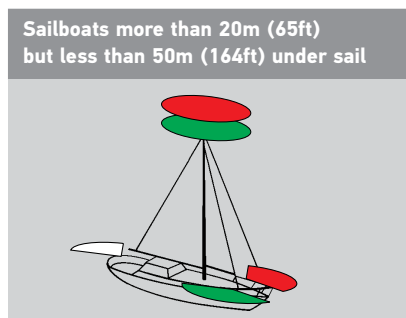

- 1x All Round Red lamp (2NM)
- 1x All Round Green lamp (2NM)
- 1x Port lamp (2NM)
- 1x Starboard lamp (2NM)
- 1x Stern lamp (2NM)

IMO COLREG requirements for navigation lighting on sailboats and powerboats less than 50m (164ft) LOA (Length Overall) at anchor.

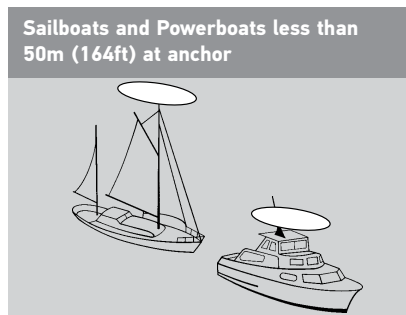

- 1x All Round White lamp (2NM)

The following images depict ADDITIONAL lighting requirements for specific activities:

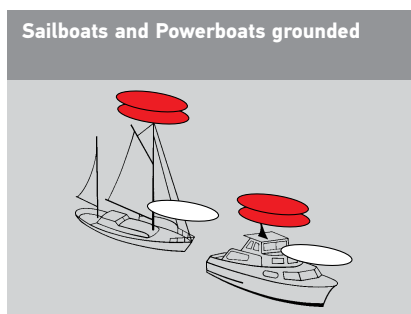

- 1x All Round White lamp (2NM)
- 2x All Round Red lamp (2NM)  
Mounted above one another

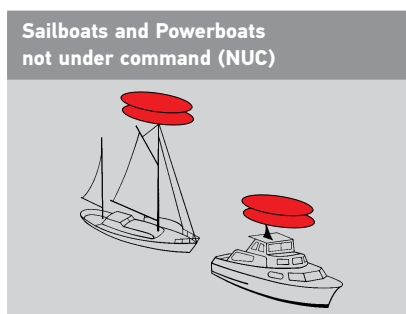

- 2x All Round Red lamp (2NM)  
Mounted above one another

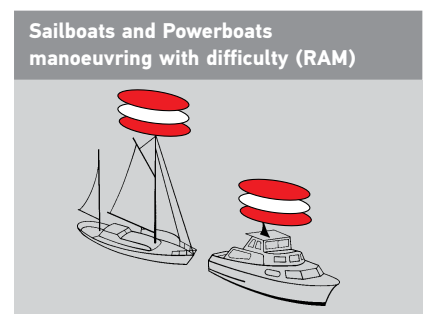

- 1x All Round Red lamp (2NM)
- 1x All Round White lamp (2NM)
- 1x All Round Red lamp (2NM)  
Mounted above one another



## NaviLED Compact 2NM

Hella marine NaviLED products are the leaders in the marine navigation signal lighting industry, having established an enviable reputation for superior light control and reliability. NaviLED Compact Port, Starboard and Stern lamps, with their 2NM visibility, cover vessel requirements up to 50m.

Designed with components that suppress possible interference, both emission as well as susceptibility to emissions, to the limits prescribed in international standards. This prevents possible interference with radio, communication, navigation and other electrical equipment on board.

Hella marine lamps are rated at IP67 and completely sealed. UV from the sun, corrosive salt air and constant vibration: these lamps are impervious to the marine environment.

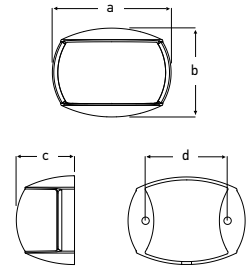

### Dimensions

a = 71mm (2.80")  
 b = 53mm (2.09")  
 c = 33mm (1.30")  
 d = 50mm (1.97")



### Single Lamps

| Lamp Type | Lens   | Cable | Black Shroud    | White Shroud    |
|-----------|--------|-------|-----------------|-----------------|
| Port      | Colour | 120mm | 2LT 980 520-001 | 2LT 980 520-011 |
| Port      | Clear  | 120mm | 2LT 980 520-101 | 2LT 980 520-111 |
| Port      | Colour | 2.5m  | 2LT 980 520-031 | 2LT 980 520-041 |
| Port      | Clear  | 2.5m  | 2LT 980 520-131 | 2LT 980 520-161 |
| Starboard | Colour | 120mm | 2LT 980 520-201 | 2LT 980 520-211 |
| Starboard | Clear  | 120mm | 2LT 980 520-301 | 2LT 980 520-311 |
| Starboard | Colour | 2.5m  | 2LT 980 520-231 | 2LT 980 520-241 |
| Starboard | Clear  | 2.5m  | 2LT 980 520-331 | 2LT 980 520-361 |
| Stern     | Clear  | 120mm | 2LT 980 520-501 | 2LT 980 520-511 |
| Stern     | Clear  | 2.5m  | 2LT 980 520-531 | 2LT 980 520-541 |

Packaging Retail carton for single pack. PN shown in table above

### Port & Starboard Pairs

| Lamp Type        | Lens   | Cable | Black Shroud     | White Shroud     |
|------------------|--------|-------|------------------|------------------|
| Port & Starboard | Colour | 120mm | 2LT 980 520-801* | 2LT 980 520-811  |
| Port & Starboard | Clear  | 120mm | 2LT 980 520-901  | 2LT 980 520-911* |

\*Packaging Retail blister for single pack. PN shown in table above

Trade Carton Pack 10pc multiple, replace final PN digit '1' with '7'

### Towing Lamps

| Lamp Type | Lens   | Cable | Black Shroud    |
|-----------|--------|-------|-----------------|
| Towing    | Colour | 120mm | 2LT 980 520-601 |

Packaging Retail blister for single pack. PN shown in table above

|                          |   |
|--------------------------|---|
| Housing Material         | UV Resistant ASA polymer  |
| Lens Material            | Enhanced impact, UV resistant acrylic                                     |
| Minimum Visible Distance | 2NM (Yachts and Powerboats)   |
| Operating Voltage        | Multivolt™ 12 / 24V DC  |
| Voltage Protection       | Spike protected to +500 volts<br>Reverse polarity protected to -700 volts |
| Power Consumption        | Port / Starboard <2W combined.<br>Stern / Towing <2W                      |
| Cable                    | Tinned marine cable   |
| Protection               | IP67 (Completely Sealed)  |
| Compliance               | IMO COLREG 72, USCG, ABYC C-5, RCM,<br>Maritime NZ, CE, RINA, UKCA        |

## NaviLED Deck Mount 2NM Pair

NaviLED Deck Mount Port and Starboard lamps, with their 2NM visibility, cover vessel requirements up to 50m. Ultra low power consumption from the highly efficient LED light source, these lamps also provide exacting light intensity across a wide range of voltage inputs from 9V DC to 32V DC.

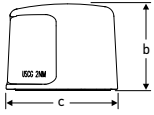
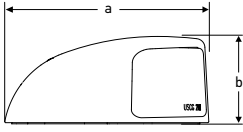

**Dimensions:**  
 a = 90mm (3.54")  
 b = 38.5mm (1.52")  
 c = 50mm (1.97")

| Lamp with Coloured Lens  | Black Housing   | White Housing   |
|--|---|-----------------|
| Port & Starboard (2NM)   | 2LT 980 620-801   | 2LT 980 620-811 |
| Lamp with Clear Lens   | Black Housing   | White Housing   |
| Port & Starboard (2NM)   | 2LT 980 620-901   | 2LT 980 620-911 |
| <i>Packaging Retail blister for 1 pair of lamps. PN shown in table above<br/>Trade Carton Pack 5pc multiple, replace final PN digit '1' with '7'</i> |   |                 |
| Housing Material   | UV Resistant ASA polymer  |                 |
| Lens Material  | Enhanced impact, UV resistant acrylic                                     |                 |
| Minimum Visible Distance   | 2NM (Yachts and Powerboats)   |                 |
| Operating Voltage  | Multivolt™ 12 / 24V DC  |                 |
| Voltage Protection   | Spike protected to +500 volts<br>Reverse polarity protected to -700 volts |                 |
| Power Consumption  | Port / Starboard <2W combined.  |                 |
| Cable  | 500mm of tinned marine cable  |                 |
| Protection   | IP67 (Completely Sealed)  |                 |
| Compliance   | IMO COLREG 72, USCG, ABYC A-16, RINA, Maritime NZ, CE, UKCA               |                 |



## NaviLED Tri-Colour 2NM

NaviLED Tri-Colour includes a 2NM rated Port, Starboard, Stern and separate Anchor function for sailing vessels under sail. Designed with components that suppress possible interference, both emission as well as susceptibility to emissions, to the limits prescribed in international standards. This prevents possible interference with radio, communication, navigation and other electrical equipment on board. Hella marine lamps are rated at IP67 and completely sealed. UV from the sun, corrosive salt air and constant vibration, these lamps are impervious to the marine environment.

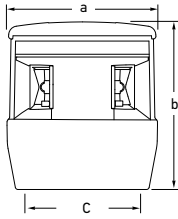

Side profile

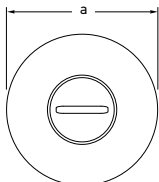

Top profile

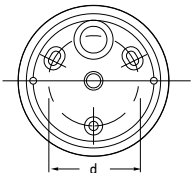

Mounting Layout

**Dimensions**  
 a = 85mm (3.35")  
 b = 95mm (3.74")  
 c = 75mm (2.95")  
 d = Ø50.8mm (2")

### Tri Colour Lamp with Anchor

| Visibility  | Black Base   |
|---|--|
| 2NM   | 2LT 980 650-001  |
| <i>Packaging Retail blister for single pack. PN shown in table above<br/>Trade Carton Pack 10pc multiple, replace final PN digit '1' with '7'</i> |  |
| Housing Material  | UV resistant, high impact nylon  |
| Lens Material   | Grilamid® plastic, impact and UV resistant                                     |
| Mounting Shaft  | 316 Stainless Steel  |
| Minimum Visible Distance  | 2 NM (Yacht)   |
| Operating Voltage   | Multivolt™ 12 / 24V DC   |
| Voltage Protection  | Spike protected to +500 volts<br>Reverse polarity protected to -700 volts      |
| Power Consumption   | Port, Starboard and Stern - <3.5W combined<br>All Round White / Anchor - <1.5W |
| Cable   | 400mm of tinned marine cable   |
| Protection  | IP67 (Completely Sealed)   |
| Compliance  | BSH, IMO COLREG 72, USCG, ABYC A-16, RCM, Maritime NZ, CE, UKCA                |



### NaviLED Trio Windex Adaptor Nut Part Number: 9NM 958 988-402

Machined 316 stainless steel adaptor nut to install a Windex directly onto the LED Tri Colour mounting shaft. M12 (Mounting Shaft) to 5/16UNC. Female to female.





## NaviLED PRO

Hella marine NaviLED products are the leaders in the marine navigation signal lighting industry, having established an enviable reputation for superior light control and reliability.

NaviLED PRO Port, Starboard, and Stern lamps 2NM are now compliant with the new ABYC C-5 standards update, and cover vessel requirements up to 50m (164ft) LOA, while the 3NM versions cover vessel sizes greater than 50m (164ft) LOA.

Designed with components that suppress possible interference, both emission as well as susceptibility to emissions, to the limits prescribed in international standards. This prevents possible interference with radio, communication, navigation and other electrical equipment on board.

Hella marine lamps are rated at IP67 and completely sealed. UV from the sun, corrosive salt air and constant vibration, these lamps are impervious to the marine environment.

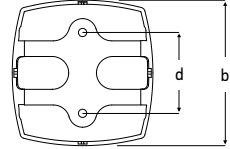
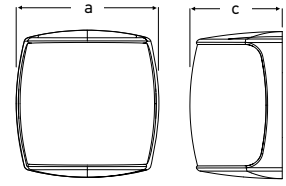

### Dimensions

a = 87mm (3.43")  
 b = 90mm (3.54")  
 c = 57mm (2.25")  
 d = 50mm (1.97")



| Lamp Type | Visibility | Black Shroud    | White Shroud    |
|-----------|------------|-----------------|-----------------|
| Port      | 2NM        | 2LT 017 460-001 | 2LT 017 460-011 |
| Port      | 3NM        | 2LT 017 460-101 | 2LT 017 460-111 |
| Starboard | 2NM        | 2LT 017 461-001 | 2LT 017 461-011 |
| Starboard | 3NM        | 2LT 017 461-101 | 2LT 017 461-111 |
| Stern     | 2NM        | 2LT 017 462-001 | 2LT 017 462-011 |
| Stern     | 3NM        | 2LT 017 462-101 | 2LT 017 462-111 |

*Packaging Retail sleeve for single pack. PN shown in table above  
 Trade Carton Pack 10pc multiple, replace final PN digit '1' with '7'*

|                    |   |
|--------------------|---|
| Visibility         | 2NM / 3NM Powerboat and Yacht   |
| Lens Material      | High impact and UV resistant acrylic                                      |
| Operating Voltage  | Multivolt™ 9–33V DC for 12 / 24V DC applications                          |
| Voltage Protection | Spike protected to +500 volts<br>Reverse polarity protected to -500 volts |
| Power Consumption  | <2W (0.17A @ 12V / 0.09A @ 24V DC)  |
| Cable              | 2.5m of tinned marine cable   |
| Protection         | IP67 (Completely Sealed)  |
| Compliance         | ABYC C-5, Wheelmark (MED), Red Ensign, UKCA, Maritime NZ, CE, RCM         |

## NaviLED PRO Deck Mount Adaptor

The NaviLED PRO Deck Mount Adaptor allows the NaviLED PRO lamps to be mounted on a horizontal surface. MoQ: 2pc

| Black Housing   | White Housing   |
|-----------------|-----------------|
| 8HG 241 287-802 | 8HG 241 287-812 |

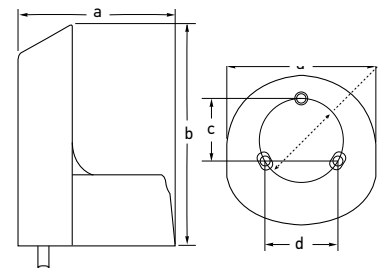

### Dimensions

a = 90mm (3.54")  
 b = 128mm (5.0")  
 c = 38mm (1.5")  
 d = 44mm (1.73")  
 e = 50.8mm (2.0")



## NavILED PRO Masthead

NavILED PRO Masthead lamps 3NM are now compliant with the new ABYC C-5 standards update, and cover vessel requirements up to 20m (65ft) LOA, while the 5NM versions cover vessel sizes 20–50m (66–164ft) LOA.

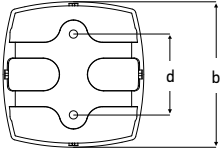
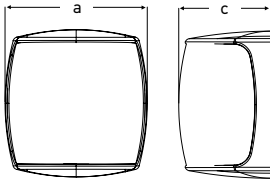

### Dimensions

a = 87mm (3.43")  
 b = 90mm (3.54")  
 c = 57mm (2.25")  
 d = 50mm (1.97")

All Hella marine products are designed with components that suppress possible interference, both emission as well as susceptibility to emissions, to the limits prescribed in international standards. This prevents possible interference with radio, communication, navigation and other electrical equipment on board.

Hella marine lamps are rated at IP67 and completely sealed. UV from the sun, corrosive salt air and constant vibration, these lamps are impervious to the marine environment.

| Lamp Type | Visibility | Black Shroud    | White Shroud    |
|-----------|------------|-----------------|-----------------|
| Masthead  | 3NM        | 2LT 959 940-201 | 2LT 959 940-211 |
| Masthead  | 5NM        | 2LT 959 940-401 | 2LT 959 940-411 |

*Packaging* Retail sleeve for single pack. PN shown in table above  
 Trade Carton Pack 10pc multiple, replace final PN digit '1' with '7'

|                    |  |
|--------------------|--|
| Visibility         | 3NM / 5NM Powerboat  |
| Lens Material      | Grilamid® plastic, impact and UV resistant   |
| Operating Voltage  | Multivolt™ 12 / 24V DC   |
| Voltage Protection | Spike protected to +500 volts<br>Reverse polarity protected to -700 volts                |
| Power Consumption  | 3NM <2.5W (0.2A @ 12V / 0.1A @ 24V)<br>5NM 4W (0.33A @ 12V / 0.17A @ 24V)                |
| Cable              | 2.5m of tinned marine cable  |
| Protection         | IP67 (Completely Sealed)   |
| Compliance         | Wheelmark (MED)*, Red Ensign*, IMO COLREG 72, USCG, ABYC C-5, Maritime NZ, CE, RCM, UKCA |

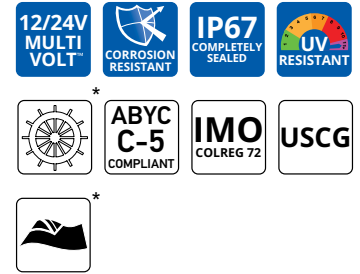

\*Wheelmark (MED) and Red Ensign applicable to 5NM only.

## NavILED PRO Bi-Colour 2NM

NavILED PRO Bi-Colour lamps are now compliant with the new ABYC C-5 standards update, and cover vessel requirements up to 20m (65ft) LOA. Designed with components that suppress possible interference, both emission as well as susceptibility to emissions, to the limits prescribed in international standards. This prevents possible interference with radio, communication, navigation and other electrical equipment on board.

Hella marine lamps are rated at IP67 and completely sealed. UV from the sun, corrosive salt air and constant vibration, these lamps are impervious to the marine environment.

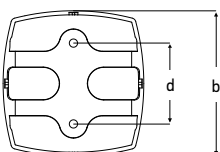
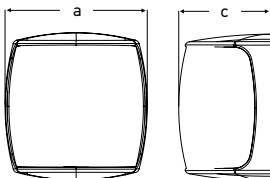

### Dimensions

a = 87mm (3.43")  
 b = 90mm (3.54")  
 c = 57mm (2.25")  
 d = 50mm (1.97")

| Lamp Type | Visibility | Black Shroud    | White Shroud     |
|-----------|------------|-----------------|------------------|
| Bi-Colour | 2NM        | 2LT 959 941-001 | *2LT 959 941-011 |

*Packaging* Retail sleeve for single pack. PN shown in table above  
 Trade Carton Pack 10pc multiple, replace final PN digit '1' with '7'

|                    |  |
|--------------------|--|
| Visibility         | 2NM Powerboat and Yacht  |
| Lens Material      | High impact and UV resistant acrylic   |
| Operating Voltage  | Multivolt™ 9-33V DC (12 / 24V DC Nominal)  |
| Voltage Protection | Spike protected to +500 volts<br>Reverse polarity protected to -700 volts                  |
| Power Consumption  | Less than 2W (0.14A @ 12V / 0.08A @ 24V)   |
| Cable              | 2.5m of tinned marine cable  |
| Protection         | IP67 (Completely Sealed)   |
| Compliance         | Wheelmark (MED), IMO COLREG 72, USCG, ABYC C-5, Maritime NZ, CE, Red Ensign, CE, RCM, UKCA |

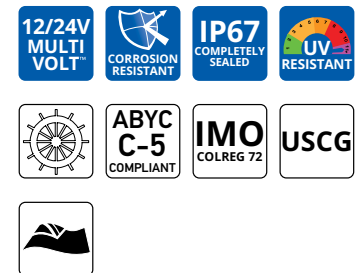

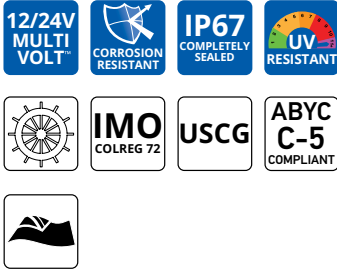

# NaviLED 360 Compact

## All Round White Navigation Lamp

With a compact mounting footprint and a variety of mounting options, NaviLED 360 Compact lamps feature single LED efficiency, advanced Multivolt™ electronics and precision optics for reliable and highly visible all round lighting. They are designed with components that suppress possible interference with radio, communication, navigation and other electrical equipment on board.

Ultra low power consumption from the highly efficient LED light source, these lamps also provide exacting light intensity across a wide range of voltage inputs from 12–24V DC.



### Anchor Lamps with Compact Surface Mount Base

| Height      | Visibility | Black Base      | White Base      |
|-------------|------------|-----------------|-----------------|
| 56mm (2.2") | 2NM        | 2LT 980 960-001 | 2LT 980 960-011 |

*Packaging Retail blister for single pack. PN shown in table above  
Trade Carton Pack 20pc multiple, replace final PN digit '1' with '7'*

### Fixed Pole Anchor Lamps

| Overall Length | Visibility | Black Base       | White Base       |
|----------------|------------|------------------|------------------|
| 167mm (6")     | 2NM        | 2LT 980 960-201  | 2LT 980 960-211  |
| 205mm (8")     | 2NM        | 2LT 980 960-231* | 2LT 980 960-241* |

*\*Packaging Retail blister for single pack. PN shown in table above  
Trade Carton Pack 20pc multiple, replace final PN digit '1' with '7'*

### Fold Down Anchor Lamps

| Overall Length | Visibility | Black Base      | White Base      |
|----------------|------------|-----------------|-----------------|
| 205mm (8")     | 2NM        | 2LT 980 960-281 | 2LT 980 960-291 |
| 315mm (12")    | 2NM        | 2LT 980 960-301 | 2LT 980 960-311 |
| 510mm (20")    | 2NM        | 2LT 980 960-321 | 2LT 980 960-331 |
| 605mm (24")    | 2NM        | 2LT 980 960-341 | 2LT 980 960-351 |
| 865mm (34")    | 2NM        | 2LT 980 960-361 | 2LT 980 960-371 |
| 1015mm (40")   | 2NM        | 2LT 980 960-461 | 2LT 980 960-471 |

*Packaging Retail blister or hangsell for single pack. PN shown in table above  
Trade Carton Pack 20pc multiple, replace final PN digit '1' with '7'*

### Plug-in Pole Anchor Lamps

| Overall Length | Visibility | Black Base      | White Base      |
|----------------|------------|-----------------|-----------------|
| 610mm (24")    | 2NM        | 2LT 980 960-401 | 2LT 980 960-411 |
| 1080mm (42")   | 2NM        | 2LT 980 960-421 | 2LT 980 960-431 |
| 1380mm (54")   | 2NM        | 2LT 980 960-441 | 2LT 980 960-451 |

*Packaging Retail blister or hangsell for single pack. PN shown in table above  
Trade Carton Pack 20pc multiple, replace final PN digit '1' with '7'*

|                          |  |
|--------------------------|--|
| Housing Material         | Corrosion, UV and impact resistant plastic   |
| Lens Material            | Grilamid® plastic, impact and UV resistant   |
| Minimum Visible Distance | 2NM  |
| Operating Voltage        | Multivolt™ 12 / 24V DC   |
| Power Consumption        | 1W   |
| Cable                    | 2 core tinned marine cable   |
| Protection               | IP67 (Completely sealed)   |
| Compliance               | IMO COLREG 72, Wheelmark (MED), USCG, ABYC C-5, Maritime NZ, CE, Red Ensign, UKCA, RCM |

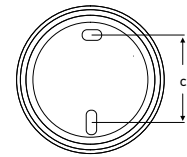
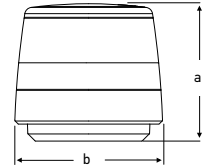

**Dimensions**  
a = 56mm (2.20")  
b = 60mm (2.36")  
c = 33mm (1.30")  
(mounting holes)



**Dimensions**  
a = 34mm (1.34")  
b = 75mm (2.95")

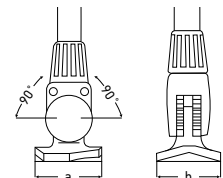

**Dimensions**  
a = 56mm (2.2")  
b = 52mm (2.05")

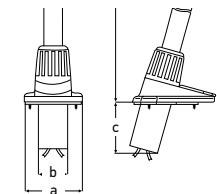

**Dimensions**  
a = 58mm (2.29")  
b = Ø30mm (1.19")  
c = 54mm (2.13")

# NaviLED 360 PRO 2NM

## All Round White, Green and Red

NaviLED 360 PRO 2NM Series All Round Navigation Lamps have a low profile surface mount design, and are available in White, Green and Red.

All Hella marine products are designed with components that suppress possible interference, both emission as well as susceptibility to emissions, to the limits prescribed in international standards. This prevents possible interference with radio, communication, navigation and other electrical equipment on board.

Hella marine lamps are rated at IP67 and completely sealed. UV from the sun, corrosive salt air and constant vibration, these lamps are impervious to the marine environment.

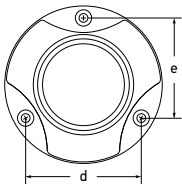
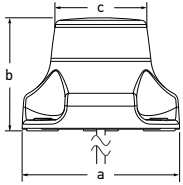

### Dimensions

- a = 90mm (3.54")
- b = 68mm (2.68")
- c = 53mm (2.09")
- d = 66mm (2.60")  
(mounting holes)
- e = 57mm (2.24")  
(mounting holes)

### Anchor and All Round Lamps with Wide Base

| Light Colour | Visibility | Black Base      | White Base      |
|--------------|------------|-----------------|-----------------|
| White        | 2NM        | 2LT 980 910-121 | 2LT 980 910-131 |
| Red          | 2NM        | 2LT 980 910-521 | 2LT 980 910-531 |
| Green        | 2NM        | 2LT 980 910-321 | 2LT 980 910-331 |

*Packaging Retail blister for single pack. PN shown in table above*

|                          |  |
|--------------------------|--|
| Housing Material         | Corrosion, UV and impact resistant plastic   |
| Lens Material            | Grilamid® plastic, impact and UV resistant   |
| Minimum Visible Distance | 2NM  |
| Operating Voltage        | Multivolt™ 12 / 24V DC   |
| Power Consumption        | 1.5W   |
| Cable                    | 1.4m of tinned marine cable  |
| Protection               | IP67 (Completely sealed)   |
| Compliance               | IMO COLREG 72, Wheelmark (MED), USCG, ABYC C-5, Maritime NZ, CE, Red Ensign, UKCA, RCM |

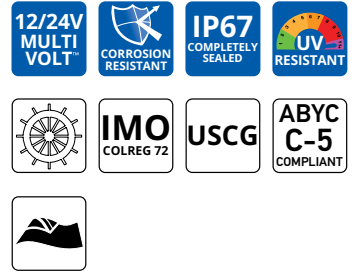



# Interior Lighting

## Lighting Your Lifestyle

**Designing or retrofitting your vessels lighting plays an important part of creating your perfect lifestyle / workspace environment.**

Hella marine's interior lighting range presents a versatile selection of luminaires designed to meet various applications. Every product in this range benefits from our three decades of expertise in LED technology, assuring you that you're choosing a lamp crafted by industry experts.

Choosing the perfect lighting solution demands thoughtful deliberation. Continue reading to uncover how Hella marine lights can genuinely transform your experience.

### **Light Output**

While lumens, measured in lumens, are often heavily promoted for modern downlights, they usually provide a poor indication of whether a light will meet your requirements. While total lumens do matter to some extent, there are more crucial factors to consider.

### **Beam Angle/Lux @ Distance**

For any given lumen count, a change to the beam angle will produce a higher lux, but over a smaller area. Narrow angle lamps are best when used to highlight a specific object with high intensity, or when the lamp is mounted up high. Wide beam angle lights are used for general purpose lighting to spread the light as wide as possible, and or where height is restricted and/or the lights need to spread as soon as possible.



### Colour Temperature or 'CCT'

This is the measure of how 'Warm' or 'Cool' the light appears. Measured on a scale of Kelvin, similar to temperature, hence the association. Warmer tones, in the 2700K to 3000K range, replicate traditional halogen filament lighting and suit where the atmosphere is designed to be cosy and inviting; Saloons and Cabins. Cooler tone, in 4500K – 5500K range, would typically be where work is taking place, or where people need to be alert; Galleys, heads and cockpits.

### Colour Rendering index or 'CRI'

LED lighting is significantly more efficient than traditional lighting sources, and a core reason for that is due to the fact that LEDs don't produce light on all spectrums. Isolated frequencies are produced that appear white to various degrees (see CCT above), but in doing so, can cause colours to appear washed out. Quality LED luminaires like the Hella marine interior range, will select LED chips that replicate more of the frequencies across the colour spectrum, which in turn means that the reflected light will produce more vibrant colours, and similar to sunlight.

### Materials / Sealing

Hella marine interior lamps are all fully sealed, allowing for these lamps to be fitted to any interior or exterior space. Being sealed is only the start, as our lamps are impervious to UV and offer mainly polymer construction. Where metal trims are required, these are typically 316 Stainless Steel, which retains its look after many years with only the occasional wipe down.



Original cabin lighting.



EuroLED 75 lighting upgrade.

## Electro Magnetic Interference (EMI)

All active electronic devices, including LED products, create some degree of EMI. The danger comes when this interference occurs in the frequency range between 156 MHz and 165 MHz, used by marine VHF and AIS systems. This can potentially compromise communication, with major operational consequences posing a serious safety risk.

However, by utilizing LED products that are purposefully engineered to mitigate EMI, owners can pro-actively steer clear of potential issues. As a result, regional and international regulatory authorities have established precise standards for LED lighting utilized on boats, particularly in the context of maritime navigation and radio communications equipment.

In the interest of safety, boat owners should prioritize the verification of both exterior and interior LED lamps to ensure they adhere to maritime EMI standards. In cases where they do not meet these standards, upgrading to high-quality models that do can be a straightforward retrofit process. Moreover, such an upgrade offers additional advantages, including increased durability, brighter illumination, and an extended lifespan that these products provide.





## EuroLED 75 Down Lights Spring / Screw Mount

The EuroLED 75 uses a highly efficient optical system that produces a very wide and even illumination that is specifically designed to reduce individual light source glare, which can lead to discomfort and eye strain.

A high colour rendering index of 85+ ensures object and surface colours are replicated naturally. EuroLED 75 is available in warm (2700K) or neutral (5000k) White light which will beautifully enhance the materials chosen for your vessel. Additional dual colour option available with Red LEDs to allow a low light mode for navigation at night. Screw or spring mount options and using a standard 50mm / 2" cutout make new or refit installation a breeze.

Completely sealed so can be used for interior and exterior, wet or dry locations. These lamps are impervious to the marine environment and can be fitted throughout the vessel, maintaining a consistent appearance.

For even more colour options, also see the Apelo RGB/W EuroLED 75 downlights (Page 11) for use with the Apelo Lighting Controller (Page 8) for total colour control.



### Round Lamps - Dual Colour

| Light Colour     | Voltage | Mounting | White Plastic Trim | Stainless Steel Trim |
|------------------|---------|----------|--------------------|----------------------|
| Red / White      | 12V     | Screw    | 2JA 015 247-011    | 2JA 015 247-021      |
| Red / White      | 12V     | Spring   | 2JA 015 247-511    | 2JA 015 247-521      |
| Red / Warm White | 12V     | Spring   | 2JA 015 247-611    | 2JA 015 247-621      |



### Round Lamps - Single Colour

| Light Colour | Voltage | Mounting | White Plastic Trim | Stainless Steel Trim |
|--------------|---------|----------|--------------------|----------------------|
| White        | 12V     | Screw    | 2JA 958 110-011    | 2JA 958 110-021      |
| White        | 24V     | Screw    | 2JA 958 110-111    | 2JA 958 110-121      |
| Warm White   | 12V     | Screw    | 2JA 958 109-011    | 2JA 958 109-021      |
| Warm White   | 24V     | Screw    | 2JA 958 109-111    | 2JA 958 109-121      |
| White        | 12V     | Spring   | 2JA 958 110-511    | 2JA 958 110-521      |
| White        | 24V     | Spring   | 2JA 958 110-611    | 2JA 958 110-621      |
| Warm White   | 12V     | Spring   | 2JA 958 109-511    | 2JA 958 109-521      |
| Warm White   | 24V     | Spring   | 2JA 958 109-611    | 2JA 958 109-621      |

**Packaging** Retail blister for single pack. PN shown in table above  
Screw Mount Trade Carton Pack 20pc multiple /  
Spring Mount Trade Carton Pack 18pc multiple,  
replace final PN digit '1' with '7'

|                    |  |
|--------------------|--|
| Trim material      | UV resistant plastic or 316 Polished Stainless Steel |
| Lumen              | 190 lumen  |
| Beam Angle         | 80°  |
| CRI                | 85   |
| Operating Voltage  | 12V DC or 24V DC voltage options                     |
| Power Consumption  | <3W (<0.19A @ 12V DC / <0.1A @ 24V DC)               |
| Colour Temperature | 5000K (White), 2700K (Warm White)                    |
| Dimming            | Via PWM or Voltage Resistive dimmer                  |
| Cable              | 120mm tinned marine cable                            |
| Protection         | IP6K7 & IP6K9K (Completely sealed)                   |
| Compliance         | CE, RCM, EN60945:2002, UKCA                          |

### EuroLED 75 - Round

#### Screw Mount

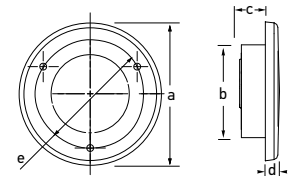

#### Spring Mount

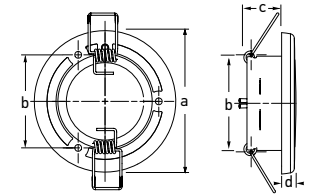

#### Round

|   |                     |
|---|---------------------|
| a | 75mm (2.95")        |
| b | 50mm (1.96") Screw  |
| b | 54mm (2.12") Spring |
| c | 16mm (0.63) Screw   |
| c | 21mm (0.82") Spring |
| d | 7mm (0.29")         |
| e | 57mm (2.24")        |

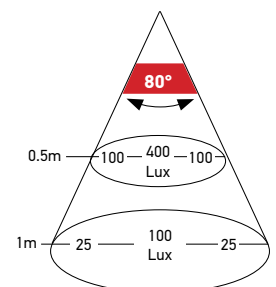

EuroLED 75



WATCH THE VIDEO



# EuroLED 95 Down Lights

## Spring / Screw Mount



Spring Mount, Stainless Trim

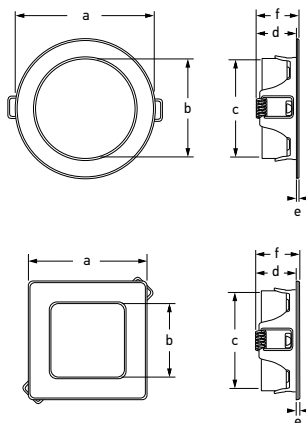

|   | Round          | Square         |
|---|----------------|----------------|
| a | 95mm (3.7")    | 78mm (3.1")    |
| b | 68mm (2.7")    | 48mm (1.9")    |
| c | 72mm (2.83")   | 72mm (2.83")   |
| d | 27.3mm (1.07") | 26.4mm (1.04") |
| e | 2mm (0.08")    | 2.5mm (0.1")   |
| f | 30mm (1.2")    | 29mm (1.14")   |

Screw Mount, White/Stainless Trim

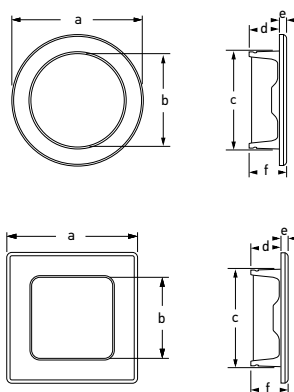

|   | Round (White/SS)                 | Square (White/SS)                |
|---|----------------------------------|----------------------------------|
| a | 97mm / 95mm<br>3.8" / 3.74"      | 80mm / 79mm<br>3.15" / 3.11"     |
| b | 68mm / 2.7"                      | 48mm / 1.85"                     |
| c | 72mm / 2.83"                     | 72mm / 2.83"                     |
| d | 22.2mm / 0.9"                    | 22.2mm / 0.9"                    |
| e | 5.5mm / 4.9mm<br>0.22" / 0.19"   | 5.5mm / 5.1mm<br>0.22" / 0.20"   |
| f | 27.7mm / 27.1mm<br>1.09" / 1.07" | 27.7mm / 27.3mm<br>1.09" / 1.07" |

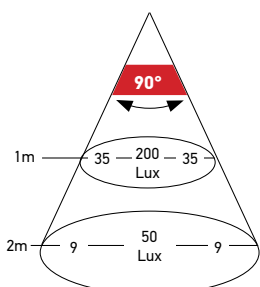

EuroLED 95

The low-profile stainless-steel trim, available in both square and round, is highly polished to super yacht standards, but without the super yacht price tag. EuroLED 95 down lights are readily dimmable and offer spring and screw mounting options designed for easy installation.

A high colour rendering index of >80 ensures object and surface colours are replicated naturally. The optional dual colour lamp enhances the offering. Choose to combine White with either Red, which enhances night-time visibility and functionality, or Blue, which creates a feeling of calm and adds 'wow-factor' to white gel coats. Low EMC noise ensures that these lamps won't interfere with radio communications.

### Round Lamps - Spring Mount

| Light Colour     | Mounting | Stainless Steel Trim |
|------------------|----------|----------------------|
| White / Red      | Spring   | 2JA 958 340-101      |
| Warm White / Red | Spring   | 2JA 958 340-121      |
| White / Blue     | Spring   | 2JA 958 340-111      |
| White            | Spring   | 2JA 958 340-011      |
| Warm White       | Spring   | 2JA 958 340-021      |

### Square Lamps - Spring Mount

| Light Colour | Mounting | Stainless Steel Trim |
|--------------|----------|----------------------|
| White        | Spring   | 2JA 958 340-511      |
| Warm White   | Spring   | 2JA 958 340-521      |
| White / Red  | Spring   | 2JA 958 340-601      |
| White / Blue | Spring   | 2JA 958 340-611      |

### Round Lamps - Screw Mount

| Light Colour     | Mounting | White Trim      | Stainless Steel Trim |
|------------------|----------|-----------------|----------------------|
| White / Red      | Screw    | 2JA 958 340-061 | 2JA 958 340-161      |
| Warm White / Red | Screw    | 2JA 958 340-071 | 2JA 958 340-171      |
| White / Blue     | Screw    | 2JA 958 340-081 | 2JA 958 340-181      |

### Square Lamps - Screw Mount

| Light Colour | Mounting | White Trim      | Stainless Steel Trim |
|--------------|----------|-----------------|----------------------|
| White / Red  | Screw    | 2JA 958 340-561 | 2JA 958 340-661      |
| White / Blue | Screw    | 2JA 958 340-581 | 2JA 958 340-681      |

*Packaging* Retail blister for single pack. PN shown in table above  
Trade Carton Pack 12pc multiple, replace final PN digit '1' with '7'

|                    |  |
|--------------------|--|
| Trim Material      | UV resistant plastic or 316 Polished Stainless Steel |
| Lumen              | 420 lumen  |
| Beam Angle         | 90°  |
| CRI                | >80  |
| Operating Voltage  | Multivolt™ 12 / 24V DC                               |
| Power Consumption  | <6W (0.5A @ 12V / 0.25A @ 24V)                       |
| Colour Temperature | 5000K (White), 2700K (Warm White)                    |
| Dimming            | Via PWM  |
| Cable              | 120mm tinned marine cable                            |
| Protection         | IP67 & IP6K9K (Completely sealed)                    |
| Compliance         | CE, RCM, EN60945:2002, UKCA                          |



Dual Colour



Single Colour



Single Colour

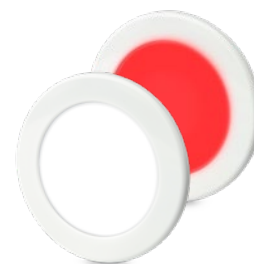

Dual Colour



## EuroLED 130 Lamps

### Dual Colour EuroLED 130 Lamps with Touch Switch

| Light Colour | White shroud     | Black Trim       |
|--------------|------------------|------------------|
| White / Red  | 2JA 959 950-121* | 2JA 959 950-111* |
| White / Blue | 2JA 959 951-121  | 2JA 959 951-111* |

### Single Colour EuroLED 130 Lamps with Touch Switch

| Light Colour | White shroud     | Black Trim      |
|--------------|------------------|-----------------|
| White        | 2JA 959 950-521* | 2JA 959 950-511 |

### Single Colour EuroLED 130 Lamps without Switch

| Light Colour | White shroud     | Black Trim       |
|--------------|------------------|------------------|
| White        | 2JA 959 820-521* | 2JA 959 820-511* |

\*Packaging Retail blister for single pack. PN shown in table above  
Trade Carton Pack 12pc multiple, replace final PN digit '1' with '7'

|                    |                                      |
|--------------------|--------------------------------------|
| Lens material      | UV resistant enhanced impact acrylic |
| Trim material      | Heavy duty nylon                     |
| Colour Temperature | 5000K (White)                        |
| Operating Voltage  | Multivolt™ 12 / 24V DC               |
| Power Consumption  | 4.0W (0.33A @ 12V / 0.16A @ 24V)     |
| Cable              | 2.5m of tinned marine cable          |
| Protection         | IP67 (Completely Sealed)             |
| Compliance         | ISO 8846 (Ignition Protection)       |

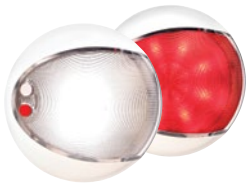

EuroLED 130 Spacer Rings  
Black 8HG 959 952-002  
White 8HG 959 952-012



EuroLED 130 Shroud  
Black 9HD 959 027-002  
White 9HD 959 027-012

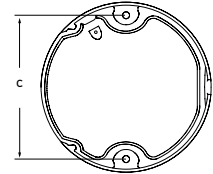
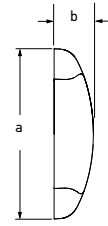

**Dimensions:**  
a = 129.5mm (5.10")  
b = 29.5mm (1.16")  
c = 110mm (4.33")

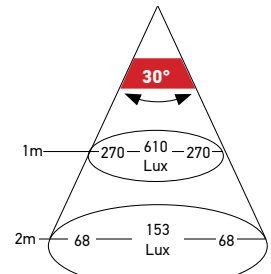

EuroLED 130



## EuroLED 150 Lamps

### Dual Colour EuroLED 150 Lamps with Touch Switch

| Light Colour     | White Plastic Trim | Stainless Steel Trim |
|------------------|--------------------|----------------------|
| White / Red      | 2JA 980 630-001*   | 2JA 980 630-011      |
| Warm White / Red | 2JA 980 630-101    | 2JA 980 630-111      |
| White / Blue     | 2JA 980 630-201    | 2JA 980 630-211      |

### Single Colour EuroLED 150 Lamps with Touch Switch

| Light Colour | White Plastic Trim | Stainless Steel Trim |
|--------------|--------------------|----------------------|
| White        | 2JA 980 630-501    | 2JA 980 630-511      |
| Warm White   | 2JA 980 630-601    | 2JA 980 630-611      |

### Single Colour EuroLED 150 Lamps without Switch

| Light Colour | White Plastic Trim | Stainless Steel Trim |
|--------------|--------------------|----------------------|
| White        | 2JA 980 631-501    | 2JA 980 631-511      |
| Warm White   | 2JA 980 631-601    | 2JA 980 631-611      |

\*Packaging Retail blister for single pack. PN shown in table above  
Trade Carton Pack 10pc multiple, replace final PN digit '1' with '7'

|                    |  |
|--------------------|--|
| Lens material      | UV resistant enhanced impact acrylic                 |
| Trim material      | UV resistant plastic or 316 Polished Stainless Steel |
| Colour Temperature | 5000K (White) 3000K (Warm White)                     |
| Operating Voltage  | Multivolt™ 12 / 24V DC                               |
| Power Consumption  | 4.0W (0.33A @ 12V / 0.16A @ 24V)                     |
| Cable              | 500mm of tinned marine cable                         |
| Protection         | IP67 (Completely Sealed)                             |

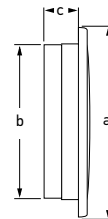
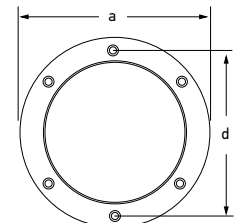
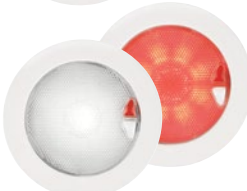
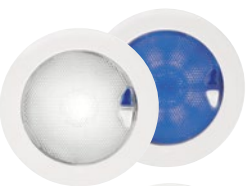

**Dimensions:**  
a = 150mm (5.90")  
b = 124mm (4.88")  
c = 20mm (0.79")  
d = 135mm (5.31")

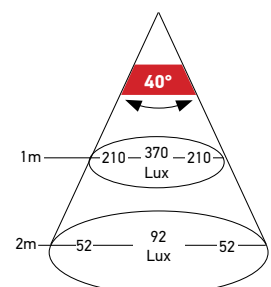

EuroLED 150

## Surface Mount Strip Lamps



Offering exceptional light output, these low-profile lamps are an ideal replacement for bulky fluorescent lighting. Producing 250 lumen (White) and offering a leading CRI rating of 85, these LEDs will enhance the appearance of your vessel and provide bright and accurate illumination. With a choice of light temperatures between 5000K White and 2700K Warm White. Bright white LEDs are best for enhanced brightness in areas like galleys and the helm, while the warm white LEDs create a cosy atmosphere, bringing out the best in wooden furniture. Dual Colour options are Red, for enhanced night vision, or Blue for the wow factor.

The sealed switch system prevents moisture and other contaminants from affecting electronics. Fastenings at each end of the lamp body are covered by Snap-On end caps for a clean and modern appearance.

### Surface mount strip lamps (with switch)

| Light Colour      | 12V              | 24V              |
|-------------------|------------------|------------------|
| White             | 2JA 958 123-001* | 2JA 958 123-401* |
| White / Red       | 2JA 958 121-001* | 2JA 958 121-401  |
| White / Blue      | 2JA 958 121-011* | 2JA 958 121-411  |
| Warm White        | 2JA 958 123-101* | 2JA 958 123-501* |
| Warm White / Red  | 2JA 958 121-101* | 2JA 958 121-501  |
| Warm White / Blue | 2JA 958 121-111  | 2JA 958 121-511* |

### Surface mount strip lamps (without switch)

| Light Colour | 12V             | 24V             |
|--------------|-----------------|-----------------|
| White        | 2JA 958 124-001 | 2JA 958 124-401 |
| Warm White   | 2JA 958 124-101 | 2JA 958 124-501 |

\*Packaging Retail blister for single pack. PN shown in table above  
Trade Carton Pack 20pc multiple, replace final PN digit '1' with '7'

|                    |   |
|--------------------|---|
| Lens Material      | UV resistant enhanced impact acrylic  |
| Colour Temperature | 5000K (White), 2700K (Warm White)   |
| CRI                | 85  |
| Power Consumption  | <3.0W (<0.25A @ 12V / <0.16A @ 24V)   |
| Operating Voltage  | 12V DC or 24V DC  |
| Dimming            | Hella marine Dimmer 5XA 998 572-001<br>(Not recommended for 2JA 958 121-xxx<br>Dual colour lamp series) |
| Cable              | 500mm of tinned marine cable  |
| Protection         | IP67 (Completely Sealed)  |
| Installation       | Surface Mount   |
| Compliance         | CE, RCM, UKCA   |

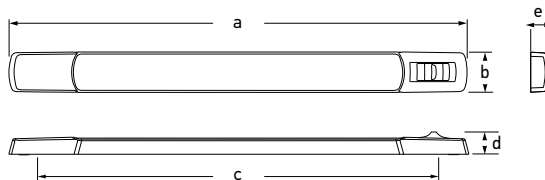

**Dimensions:**  
a = 283mm (11.14")  
b = 25mm (1.0")  
c = 265mm (10.43")  
d = 14mm (0.55") Switch Cap  
e = 11mm (0.43") Plain Cap

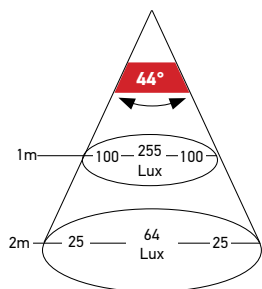

Surface Mount Strip Lamp



### Strip Lamp Accessories

| Accessory                     | Part Number     |
|-------------------------------|-----------------|
| 45° Mounting Bracket White    | 8HG 958 000-011 |
| 45° Mounting Bracket Charcoal | 8HG 958 000-021 |





## DuraLED 12

The DuraLED 12 lamps are surface mounted and feature a unique installation system where the fastening load is taken up by a heavy-duty nylon bush to eliminate possible stress on the lamp housing. Purposely designed for engine rooms, storage lockers, lazarettes and applications where reliability must not be compromised.



Low EMC noise ensures that these lamps won't interfere with radio communications. Completely sealed to ISO 8846 and have protection against ignition of surrounding flammable gases. This means they can be used in high risk areas, interior and exterior, wet or dry locations. These lamps are impervious to the marine environment and can be fitted throughout the vessel, maintaining a consistent appearance.

| Light Colour       | Switch  | Non Switch      |
|--------------------|---|-----------------|
| White              | 2JA 980 704-001   | 2JA 959 700-101 |
| Packaging          | Trade Carton for single pack  |                 |
| Installation       | Surface mount with robust bush mount                                      |                 |
| Lens material      | UV resistant enhanced impact acrylic                                      |                 |
| Shroud Material    | Heavy duty nylon  |                 |
| Colour Temperature | 5000K (White)   |                 |
| Power Consumption  | <2.5W (<0.20A @ 12V / <0.10A @ 24V)                                       |                 |
| Voltage Protection | Spike protected to +500 volts<br>Reverse polarity protected to -700 volts |                 |
| Operating Voltage  | Multivolt™ 12 / 24V DC  |                 |
| Cable              | 500mm of tinned marine cable  |                 |
| Protection         | IP67 (Completely Sealed)  |                 |
| Compliance         | CE, ISO 8846 (Ignition protection), RCM, UKCA, ECE R10                    |                 |

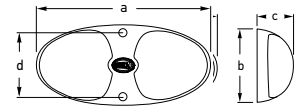

### Dimensions

a = 140mm (5.51")  
b = 65mm (2.56")  
c = 32mm (1.26")  
d = 47mm (1.85")

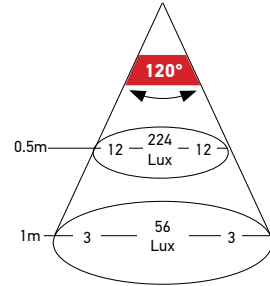

5000 K - 12 LED



## DuraLED 20 / 36

DuraLED lamps provide powerful white light, a safe, energy efficient and reliable alternative to incandescent and fluorescent lighting.



Low EMC noise ensures that these lamps won't interfere with radio communications. Completely sealed to ISO 8846 and have protection against ignition of surrounding flammable gases. This means they can be used in high risk areas, interior and exterior, wet or dry locations. These lamps are impervious to the marine environment and can be fitted throughout the vessel, maintaining a consistent appearance.

| Light Colour       | 20 / Spread lens   | 36 / Spread lens |
|--------------------|--|------------------|
| White              | 2JA 980 608-001  | 2JA 959 037-521  |
| Packaging          | Trade Carton for single pack   |                  |
| Installation       | Surface mount with robust bush mount   |                  |
| Lens material      | UV resistant enhanced impact acrylic   |                  |
| Colour Temperature | 6500K (White) DuraLED 20<br>5000K (White) DuraLED 36                                 |                  |
| Operating Voltage  | Multivolt™ 12 / 24V DC   |                  |
| Voltage Protection | Spike protected to +500 volts<br>Reverse polarity protected to -700 volts            |                  |
| Power Consumption  | 20 LED <4W (<0.33A @ 12V / <0.17A @ 24V)<br>36 LED <7W (<0.51A @ 12V / <0.28A @ 24V) |                  |
| Cable              | 2.5m of tinned marine cable  |                  |
| Protection         | IP67 (Completely Sealed)   |                  |
| Compliance         | CE, ISO 8846 (Ignition protection), RCM, UKCA  |                  |

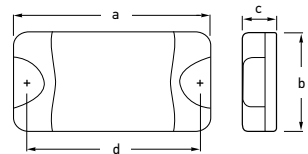

### Dimensions

a = 177mm (6.97")  
b = 100mm (3.94")  
c = 30mm (1.18")  
d = 148mm (5.83")

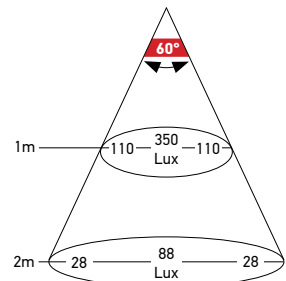

5000 K - 20 LED

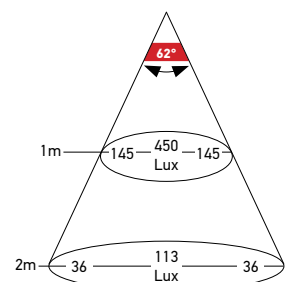

5000 K - 36 LED

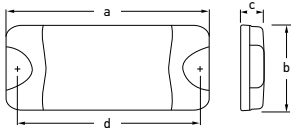

**Dimensions:**

- a = 222mm (8.74")
- b = 96mm (3.78")
- c = 25mm (0.98")
- d = 193mm (7.60")

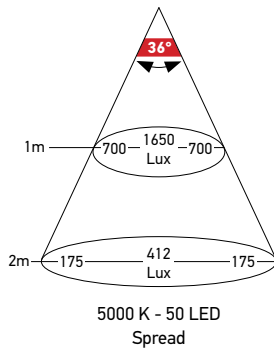
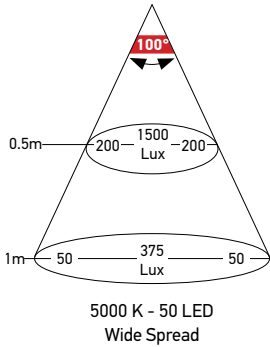

## DuraLED 50 Low Profile (LP)

Purposely designed for engine rooms, storage lockers, lazarettes and heavy-duty applications where reliability must not be compromised. Advanced lens and optic engineering ensures an extremely wide spread of light without glare or harsh point sources.

Product reliability is second to none, proven worldwide in thousands of highly demanding applications. Each lamp is completely sealed, impact resistant and shock resistant, ensuring an ultra long service life. Low EMC noise ensures that these lamps won't interfere with radio communications.

The DuraLED 50 lamps are completely sealed to ISO 8846 and have protection against ignition of surrounding flammable gases. This means they can be used in high-risk areas, interior and exterior, wet or dry locations.



| Light Colour              | Spread lens   | Wide Spread lens |
|---------------------------|---|------------------|
| White                     | 2JA 980 629-001   | 2JA 980 629-501  |
| <i>Packaging</i>          | <i>Trade Carton for single pack</i>                                       |                  |
| <i>Installation</i>       | Surface mount with robust bush mount                                      |                  |
| <i>Lens material</i>      | UV resistant enhanced impact acrylic                                      |                  |
| <i>Colour Temperature</i> | 5000K (White)   |                  |
| <i>Operating Voltage</i>  | Multivolt™ 12 / 24 DC   |                  |
| <i>Voltage Protection</i> | Spike protected to +500 volts<br>Reverse polarity protected to -700 volts |                  |
| <i>Power Consumption</i>  | <12W (<1.0A @ 12V / <0.5A @ 24V)  |                  |
| <i>Cable</i>              | 2.5m of tinned marine cable   |                  |
| <i>Protection</i>         | IP67 (Completely Sealed)  |                  |
| <i>Compliance</i>         | CE, ISO 8846 (Ignition protection), RCM, UKCA                             |                  |

## DuraLED 50 Red / White

DuraLED lamps provide powerful White or Red light, a safe, energy efficient and reliable alternative to incandescent and fluorescent lighting. The secondary red LED colour also adds increased functionality by enhancing night time visibility.

Each lamp is completely sealed, impact resistant and shock resistant, ensuring an ultra long service life.

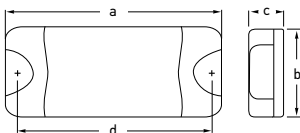

**Dimensions:**

- a = 222mm (8.66")
- b = 96mm (3.78")
- c = 31mm (1.22")
- d = 193mm (7.60")

| Light Colour              | Spread lens  |
|---------------------------|--|
| White / Red               | 2JA 980 604-061  |
| <i>Packaging</i>          | <i>Trade Carton for single pack</i>  |
| <i>Installation</i>       | Surface mount with robust bush mount                                       |
| <i>Lens material</i>      | UV resistant enhanced impact acrylic                                       |
| <i>Colour Temperature</i> | 5000K (White) and Red  |
| <i>Operating Voltage</i>  | Multivolt™ 12 / 24 DC  |
| <i>Voltage Protection</i> | Spike protected to +500 volts,<br>Reverse polarity protected to -700 volts |
| <i>Power Consumption</i>  | <10W (<0.80A @ 12V / <0.39A @ 24V)   |
| <i>Cable</i>              | 0.5m of tinned marine cable  |
| <i>Protection</i>         | IP67 (Completely Sealed)   |
| <i>Compliance</i>         | CE, ISO 8846 (Ignition protection), RCM, UKCA                              |





## LED Flexi Chart / Reading Lamps

LED Chart/Reading lamps offer energy efficient lighting for a variety of interior applications, including chart table and navigation area lighting, berth lighting and adjustable reading lights.

A UV and Impact resistant plastic housing, and a coated steel or 316 Stainless arm makes these lamps extraordinarily robust.

Low EMC noise ensures that these lamps won't interfere with radio communications.

The chart lamps are rated IP53 and are suitable for areas that may be exposed to rain or similar wet environments.



Dual colour LED chart table lamps feature a rotary dial for on / off and red / white light control and dimming.

| Light Colour | 150mm Shaft      | 400mm Shaft      |
|--------------|------------------|------------------|
| White / Red  | 2JA 343 720-522* | 2JA 343 720-622  |
| White        | 2JA 346 720-022* | 2JA 346 720-122* |
| Red          |                  | 2JA 343 720-152* |

\*Packaging Retail blister for single pack. PN shown in table above  
Trade Carton Pack 24pc multiple, replace final PN digit '1' with '7'

|                     |   |
|---------------------|---|
| Housing Description | UV and impact resistant plastic   |
| Arm material        | Single colour - Coated steel arm<br>Dual colour red / white - 316 stainless arm |
| Operating Voltage   | Multivolt™ 12 / 24V DC  |
| Power Consumption   | <2W (<0.16A @ 12V / <0.08A @ 24V)   |
| Cable               | 120mm of cable  |
| Protection          | IP53  |
| Compliance          | CE, ECE R10   |

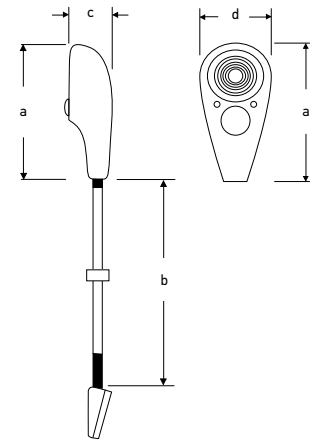

### Dimensions:

a = 104mm (4.09")  
b = 150mm (5.91")  
400mm (15.75")  
c = 36mm (1.42")  
d = 46mm (1.81")

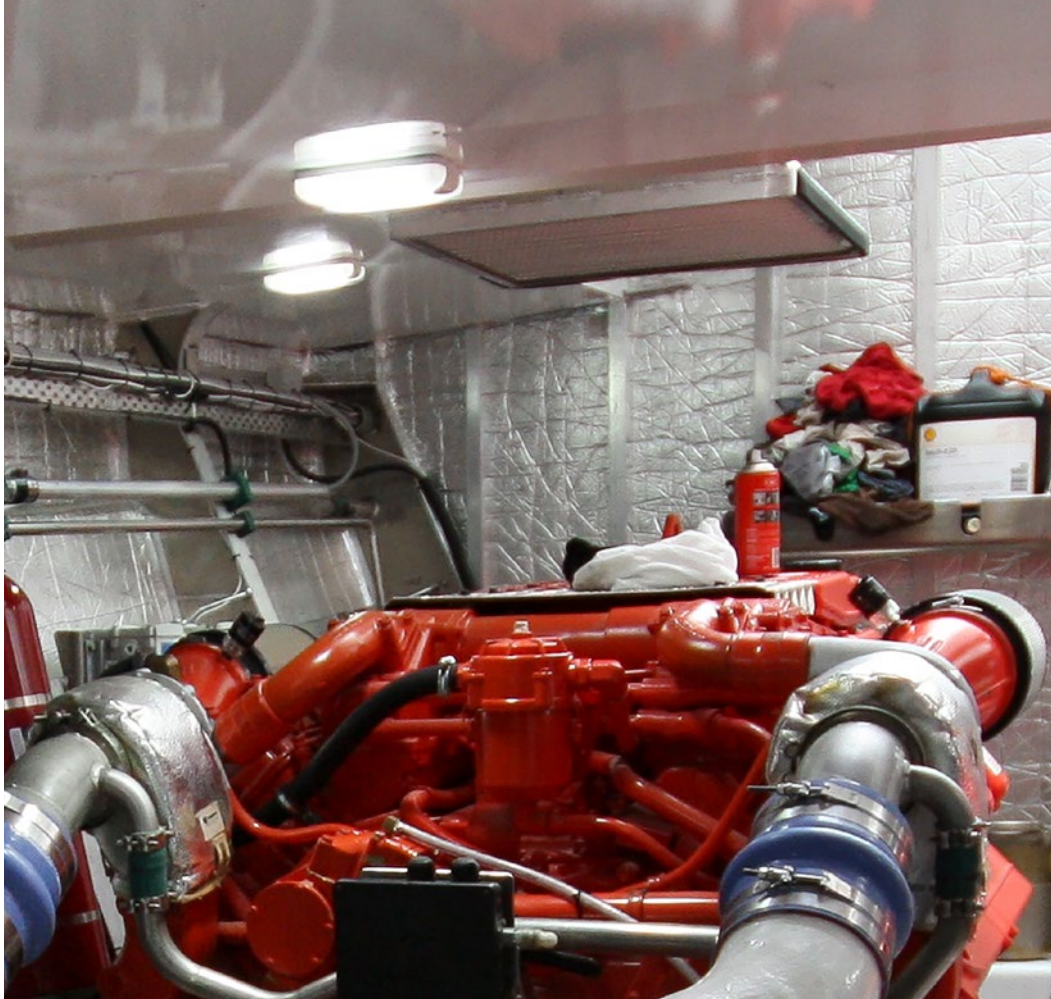

# DuraLED

## for Maximum Reliability

Purpose designed for engine rooms and heavy duty applications.  
Wide, even, glare-free illumination below decks and low vertical spaces.

Safety assured, even under severe voltage fluctuations, and ISO Ignition Protected for certified installation near flammable gas sources.

**For uncompromising reliability and safety,  
choose DuraLED.**



**COMPACT, ENERGY EFFICIENT, RELIABLE & ULTRA DURABLE**



# Courtesy Lighting

## Create Your Style

**Hella marine courtesy lamp series offer subtle ambient lighting to highlight specific areas in your vessel. Available in a range of attractive colourways, or with a highly polished stainless steel clip on cover.**

These lights are great to use during both day and night and are often installed in transom walkthroughs, gangways, inside smaller lockers, under gunnels or around the perimeter of the walk around. Other applications may include stairs, toe kicks, and storage areas.

Colour options are available to match interior lighting colour temperatures of either cool or warm white, or alternatively a red or blue option are available for utility or to create more interesting looks. For even more colour options, also see the new Apelo RGB Step Lamps (Page 11) for use with the Apelo Lighting Controller (Page 8) for total colour control.

Each lamp is completely sealed, highly shock, impact and vibration resistant making them suitable for the demanding marine environment. Lamps can be installed on a vessel's interior or exterior, and operate in wet or dry conditions.

Hella marine courtesy lamps are reverse polarity protected, and Multivolt™ electronics ensure constant light output across a wide variety of voltage inputs from 9-32V DC, for nominal 12V or 24V DC systems.

The Hella marine courtesy lamp range is made in New Zealand and supported by a 5 year warranty for complete peace of mind.



Surface and flush mount models for unobtrusive safety lighting

## Easy Fit Step Lamps

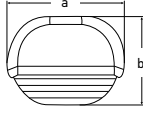
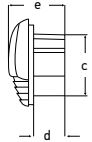

### Dimensions:

a = 45mm (1.77")  
 b = 31.5mm (1.24")  
 c = 25.4mm (1.00")  
 d = 14mm (0.55")  
 e = 22.7mm (0.89")

| Light Colour | Chrome Plated Trim | White Plastic Trim | Stainless Steel Trim |
|--------------|--------------------|--------------------|----------------------|
| White        | 2JA 958 126-001    | 2JA 958 126-011    | 2JA 958 126-031      |
| Warm White   | 2JA 958 126-401    | 2JA 958 126-411    | 2JA 958 126-431      |
| Blue         | 2JA 958 126-101    | 2JA 958 126-111    | 2JA 958 126-131      |
| Red          | 2JA 958 126-201    | 2JA 958 126-211    | 2JA 958 126-231      |

*Packaging* Retail blister for single pack. PN shown in table above  
 Trade Carton Pack 20pc multiple, replace final PN digit '1' with '7'

|                   |  |
|-------------------|--|
| Lens Material     | UV resistant enhanced impact acrylic                               |
| Cap Material      | White plastic, chrome plated plastic, polished 316 stainless steel |
| Operating Voltage | Multivolt™ 12 / 24V DC   |
| Power Consumption | 0.5W (<0.04A @ 12V / <0.02A @ 24V)                                 |
| Cable             | 100mm of tinned marine cable                                       |
| Protection        | IP67 (Completely Sealed)   |
| Compliance        | CE, RCM, UKCA  |



For even more colour options, also see the Apelo RGB Step Lamps (Page 11) for use with the Apelo Lighting Controller (Page 8) for total colour control.

## Surface Mount Oblong Courtesy Lamps

| Light Colour | Stainless Steel Trim | White Body (Single) | White Body (Bulk) |
|--------------|----------------------|---------------------|-------------------|
| White        | 2XT 980 869-301*     | 98085510            | 2XT 980 869-317   |
| Warm White   | 2XT 980 869-401*     | 98085515            | 2XT 980 869-417   |
| Blue         | 2XT 980 869-601*     | 98085540            | 2XT 980 869-617   |
| Red          | 2XT 980 869-501*     | 98085535            | 2XT-980-869-517   |

*\*Packaging* Retail blister for single pack, Trade Carton Pack 24pc multiple, replace final PN digit '1' with '7' (Stainless Only).

|                   |                                    |
|-------------------|------------------------------------|
| Lens Material     | Impact resistant acrylic           |
| Cap Material      | 316 stainless steel                |
| Operating Voltage | Multivolt™ 12 / 24V DC             |
| Power Consumption | 0.5W (<0.04A @ 12V / <0.02A @ 24V) |
| Cable             | 120mm of tinned marine cable       |
| Protection        | IP67 (Completely Sealed)           |
| Compliance        | CE, RCM, UKCA                      |

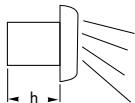
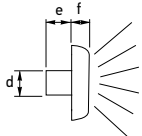
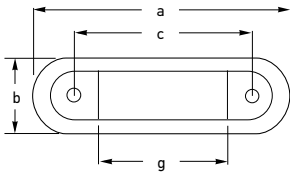

### Dimensions:

a = 84 mm / 3.31"  
 b = 29 mm / 1.14"  
 c = 58 mm / 2.28"  
 d = ø10 mm / 0.39"  
 e = 10 mm / 0.39"  
 f = 9 mm / 0.35"  
 g = 44 mm / 1.74"



## Flush Mount Oblong Step Lamps

| Light Colour | Stainless Trim  | Satin Stainless Trim   |
|--------------|-----------------|------------------------|
| White        | 2XT 959 680-811 | 2XT 959 680-857 (Bulk) |
| Warm White   | 2XT 959 680-411 |                        |
| Blue         | 2XT 959 680-611 |                        |
| Red          | 2XT 959 680-711 |                        |

| Accessory                         | Part Number     |
|-----------------------------------|-----------------|
| Polished 316 Stainless Steel Trim | 9AR 998 019-001 |
| Satin 316 Stainless Steel Trim    | 9AR 959 685-061 |
| Black Plastic Trim                | 9AB 959 686-001 |

*Packaging* Retail blister for single pack. PN shown in table above  
 Trade Carton Pack 24pc multiple, replace final PN digit '1' with '7'

|                   |                                    |
|-------------------|------------------------------------|
| Lens Material     | Impact resistant acrylic           |
| Cap Material      | 316 Stainless Steel                |
| Operating Voltage | Multivolt™ 12 / 24V DC             |
| Power Consumption | 0.5W (<0.04A @ 12V / <0.02A @ 24V) |
| Cable             | 120mm of tinned marine cable       |
| Protection        | IP67 (Completely Sealed)           |
| Compliance        | CE, RCM, UKCA                      |





## Round Lamps

### White Light Round Lamps†



| Trim Finish          | 12V              | 24V              |
|----------------------|------------------|------------------|
| Stainless steel trim | 2XT 980 500-521* | 2XT 980 501-521  |
| White plastic trim   | 2XT 980 500-541* | 2XT 980 501-541* |

†Includes a surface mounting spacer ring and stainless steel screws.

### Blue Light Round Lamps



| Trim Finish          | 12V              | 24V              |
|----------------------|------------------|------------------|
| Stainless steel trim | 2XT 980 502-221* | 2XT 980 503-221* |
| White plastic trim   | 2XT 980 502-241* | 2XT 980 503-241  |

|                   |   |
|-------------------|---|
| Lens Material     | UV resistant enhanced impact acrylic      |
| Trim Material     | UV resistant plastic. 316 stainless steel |
| Dimming           | Hella marine Dimmer 5XA 998 572-001       |
| Operating Voltage | 12V DC or 24V DC                          |
| Power Consumption | <0.5W (<0.04A @ 12V / <0.02A @ 24V)       |
| Cable             | 120mm of tinned marine cable              |
| Protection        | IP67 (Completely Sealed)                  |
| Mounting          | Stainless steel screws included           |

### Warm White Round Lamps†



| Trim Finish          | 12V              | 24V              |
|----------------------|------------------|------------------|
| Stainless steel trim | 2XT 980 500-721  | 2XT 980 501-721* |
| White plastic trim   | 2XT 980 500-741* | 2XT 980 501-741  |

†Includes a surface mounting spacer ring and stainless steel screws.

### Red Light Round Lamps



| Trim Finish          | 12V              | 24V              |
|----------------------|------------------|------------------|
| Stainless steel trim | 2XT 980 507-221  | 2XT 980 508-221  |
| White plastic trim   | 2XT 980 507-241* | 2XT 980 508-241* |

\*Packaging Retail blister for single pack. PN shown in table above  
Trade Carton Pack 24pc multiple, replace final PN digit '1'  
with '7'

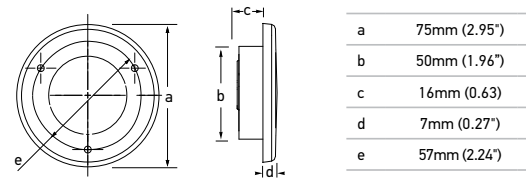

## Square Lamps

### White Light Square Lamps\*



| Trim Finish        | 12V             | 24V             |
|--------------------|-----------------|-----------------|
| Chrome plated trim | 2XT 980 580-571 | 2XT 980 581-571 |
| White plastic trim | 2XT 980 580-551 |                 |

\*Includes a surface mounting spacer ring and stainless steel screws.

### Blue Light Square Lamps



| Trim Finish        | 12V             | 24V |
|--------------------|-----------------|-----|
| Chrome plated trim | 2XT 980 582-271 |     |

|                   |  |
|-------------------|--|
| Lens Material     | UV resistant enhanced impact acrylic     |
| Trim Material     | UV resistant plastic. Chrome plated trim |
| Dimming           | Hella marine Dimmer 5XA 998 572-001      |
| Operating Voltage | 12V DC or 24V DC                         |
| Power Consumption | <0.5W (<0.04A @ 12V / <0.02A @ 24V)      |
| Cable             | 120mm of tinned marine cable             |
| Protection        | IP67 (Completely Sealed)                 |
| Mounting          | Stainless Steel screws included          |

### Warm White Light Square Lamps\*



| Trim Finish        | 12V             | 24V             |
|--------------------|-----------------|-----------------|
| Chrome plated trim | 2XT 980 580-771 |                 |
| White plastic trim |                 | 2XT 980 581-751 |

\*Includes a surface mounting spacer ring and stainless steel screws.

### Red Light Square Lamps



| Trim Finish        | 12V             | 24V             |
|--------------------|-----------------|-----------------|
| Chrome plated trim | 2XT 980 587-271 | 2XT 980 588-271 |
| White plastic trim | 2XT 980 587-251 | 2XT 980 588-251 |

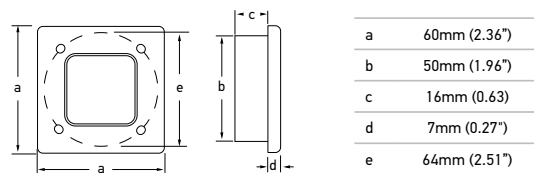

## Courtesy Strip Lamps



A shallow 10mm profile, completely sealed housings and class leading efficiency for illumination duties from interior downlighting to cockpit enhancing courtesy lighting.

These strip lamps provide a soft and uniform courtesy light pattern in white, warm white, blue or red. The range is ideal for interior or exterior applications including storage lockers, under cabinetry, under gunnels and more. Surface mount installation with fastenings in each end of the lamp body are covered by snap-on end caps for a clean and modern appearance.

### Surface Mount Courtesy

| Light Colour | 12V              | 24V              |
|--------------|------------------|------------------|
| White        | 2JA 980 881-012* | 2JA 980 881-112* |
| Warm White   | 2JA 980 881-212  |                  |
| Blue         | 2JA 980 881-402* | 2JA 980 881-502  |
| Red          | 2JA 980 881-602  | 2JA 980 881-702  |

\*Packaging Retail blister for single pack. PN shown in table above  
Trade Carton Pack 20pc multiple, replace final PN digit '2' with '7'

|                    |  |
|--------------------|--|
| Lens Material      | UV resistant enhanced impact acrylic   |
| Colour Temperature | 5000K (White), 2700K (Warm White)      |
| Operating Voltage  | 12V DC or 24V DC                       |
| Power Consumption  | White 1.5W (0.15A @ 12V / 0.06A @ 24V) |
| Cable              | 500mm of tinned marine cable           |
| Protection         | IP67 (Completely Sealed)               |

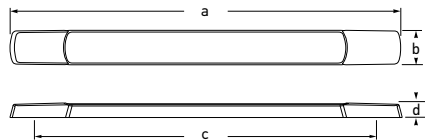
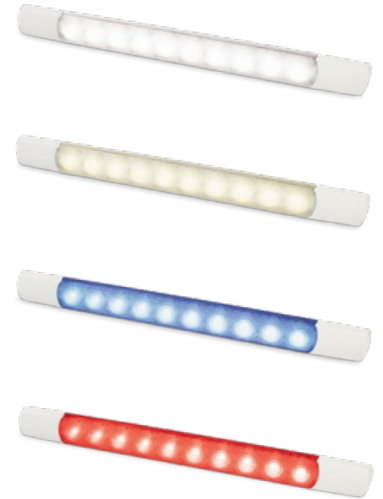

#### Dimensions:

a = 283mm (11.14")  
b = 25mm (1.0")  
c = 265mm (10.43")  
d = 11mm (0.43")

### Strip Lamp Accessories

| Accessory                     | Part Number     |
|-------------------------------|-----------------|
| 45° Mounting Bracket White    | 8HG 958 000-011 |
| 45° Mounting Bracket Charcoal | 8HG 958 000-021 |





## LED Livewell / Courtesy Lamps

Livewell lamps are designed for installation into live bait tanks with a wall thickness up to 26mm. Supplied with a plastic nut and rubber gaskets for a watertight seal, installation is swift and secure into often inaccessible locations.

Often used as courtesy lamps due to their low power consumption and rugged construction. Fit these at ground level for a unique look in your vessel.



| Lamp Colour | Part Number      |
|-------------|------------------|
| White       | 2JA 998 543-051* |
| Blue        | 2JA 998 543-031* |
| Amber       | 2JA 998 543-001  |
| Red         | 2JA 998 543-021* |

*\*Packaging Retail blister for single pack. PN shown in table above  
Trade Carton Pack 50pc multiple, replace final PN digit '1' with '7'*

|                     |                                      |
|---------------------|--------------------------------------|
| Housing Description | Heavy duty polycarbonate             |
| Operating Voltage   | 12V DC                               |
| Power Consumption   | 0.5W (<0.04A @ 12V)                  |
| Cable               | 120mm of cable                       |
| Protection          | IP67 - Completely sealed             |
| Mounting            | Single hole. Rubber gaskets included |

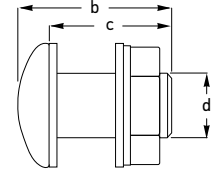
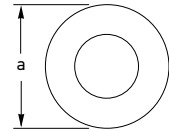

**Dimensions**  
a = 50mm / 1.97"  
b = 49mm / 1.93"  
c = 40mm / 1.57"  
d = 26mm / 1.02"



## Multi-flash Signal Lamps

Multi-purpose signal lamps with robust housings, 10 programmable flash modes and the ability to be synchronised to flash alternately or in unison.

Each lamp is a completely sealed unit. Proven design, precision engineering and the use of high impact acrylic materials ensure superior resistance to water, impact, UV and wear and tear.

Advanced Multivolt™ circuitry provides reliable illumination across a range of DC inputs from 9-33 volts, even during low battery voltages, and voltage drop over long cable runs.

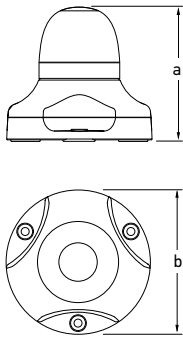

**Dimensions**  
a = 83mm / 3.27"  
b = ø90mm / 3.54"

### 360° Multi-flash Signal Lamp

| Lamp Colour                | Part Number  |
|----------------------------|--|
| White                      | 2XD 980 911-002  |
| Green                      | 2XD 980 911-202  |
| Red                        | 2XD 980 911-402  |
| Amber                      | 2XD 980 911-602  |
| Blue                       | 2XD 980 911-702  |
| <i>Packaging</i>           | <i>Trade Carton for single pack</i>  |
| <b>Housing Description</b> | Corrosion, UV and impact resistant plastic                                 |
| <b>Lens Material</b>       | Ultra heavy duty Grilamid® lens  |
| <b>Operating Voltage</b>   | Multivolt™ 9-33V DC  |
| <b>Voltage Protection</b>  | Spike protected to +500 volts  |
| <b>Power Consumption</b>   | 5W (<0.42A @ 12V / <0.021A @ 24V)<br>(Continuously on) Less in flash modes |
| <b>Cable</b>               | 2.5m of cable  |
| <b>Protection</b>          | IP67 - Completely sealed   |
| <b>Compliance</b>          | RCM, ECE R10   |



### DuraLED Multi-flash Signal Lamps

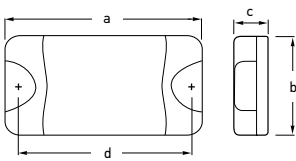

**Dimensions**  
a = 177mm (6.97")  
b = 100mm (3.94")  
c = 30mm (1.18")  
d = 148mm (5.83")

| Lamp Colour                | Part Number   |
|----------------------------|---|
| Red                        | 2XD 959 037-012   |
| Amber                      | 2XD 959 037-112   |
| Blue                       | 2XD 959 037-612   |
| Green                      | 2XD 959 037-812   |
| <i>Packaging</i>           | <i>Trade Carton for single pack</i>   |
| <b>Housing Description</b> | Corrosion, UV and impact resistant plastic                                  |
| <b>Lens Material</b>       | Heavy duty acrylic lens   |
| <b>Operating Voltage</b>   | Multivolt™ 9-33V DC   |
| <b>Voltage Protection</b>  | Spike protected to +500 volts   |
| <b>Power Consumption</b>   | <9W (<0.75A @ 12V / <0.375A @ 24V)<br>(Continuously on) Less in flash modes |
| <b>Cable</b>               | 2.5m of cable   |
| <b>Protection</b>          | IP67 - Completely sealed  |
| <b>Compliance</b>          | RCM, ECE R10  |





# TRAILER LIGHTING & ACCESSORIES



## Submersible LED Trailer Lamps

Sold as a pair, the submersible trailer lamps are ADR Compliant and include the complete combination of functions required for on-road driving. Each lamp is completely sealed against dust and moisture ingress.

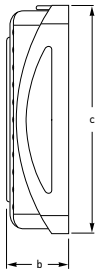
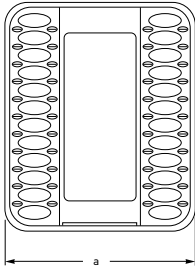

### Dimensions

a = 80mm / 3.15"  
b = 26mm / 1.03"  
c = 96mm / 3.78"

- Stop/Brake
- Rear position/Park
- Rear indicator lamps
- Number plate (Only on 1 side)
- 18cm<sup>2</sup> red reflector.

| Trailer Kit Contents          | Part Number                 |
|-------------------------------|-----------------------------|
| Trailer Pack Pair, 0.5m Cable | 2395-TP (2VB 980 720-811)   |
| Trailer Pack Pair, 9m Cable   | 2395-TP9M (2VB 980 720-821) |

*Packaging Retail blister for single pack*

|                    |  |
|--------------------|--|
| Lens Material      | Grilamid® plastic, impact and UV resistant                                     |
| Mounting           | Horizontal or vertical   |
| Operating Voltage  | Multivolt™ 12 / 24V DC   |
| Power Consumption  | Stop: 2W / Rear direction indicator: 2W<br>Rear position 1W / Number plate: 1W |
| Voltage Protection | Spike, Over Voltage and Reverse Polarity                                       |
| Cable              | 0.5m or 9m multi-core cable  |
| Compliance         | ADR compliant*   |

\*Not available in all markets.



Stop



Rear Direction Indicator



Rear Position/Number Plate

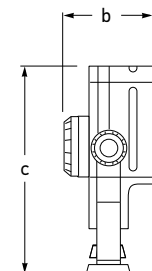
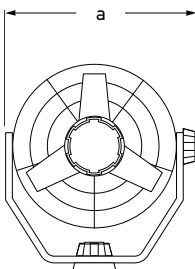

### Dimensions

a = 188mm / 7.41"  
b = 95mm / 3.75"  
c = 195mm / 7.67"

## Two Speed Hella marine Turbo Fans

Hella Turbo Fans offer ventilation into areas that may not have suitable airflow.

- Quiet operation
- 150mm diameter fan blade with guard
- High air moving capacity with low power consumption
- Two speed switch in front of the blade guard

| Voltage | Housing Colour | Part Number              |
|---------|----------------|--------------------------|
| 12V     | Black Housing  | 8EV 003 361-001 (6100)   |
| 12V     | White Housing  | 8EV 003 361-022 (6100-W) |
| 24V     | Black Housing  | 8EV 003 361-011 (6101)   |

*Packaging Retail Carton for single pack*

|                      |  |
|----------------------|--|
| Material Description | Impact resistant plastic                             |
| Switch               | Integrated 2 stage rotary                            |
| Output               | Speed 1: 70 litre / sec.<br>Speed 2: 95 litre / sec. |
| Power Consumption    | 6.5W   |



## Battery Master Switches

### 275 Amp Battery Master Switch

Contour Lock system with removable plates allows the switch to be a stand alone unit or locked together with other switches. The control knob cannot be removed whilst in an ON or OFF position, however, it can be removed by switching to an anti-clockwise 45° position. Suitable for surface or recess mounting by cutting a 52mm diameter hole.



#### Part Number

4640 (6EK 998 540-002)

|                       |   |                        |
|-----------------------|---|------------------------|
| Housing Material      | Impact resistant plastic. Tin plated studs. |                        |
| Termination Stud Size | 2 x 10mm (3/4")                             |                        |
| Operation             | ON / OFF                                    |                        |
| Protection            | IP56  |                        |
| Max. Load 12 / 24V DC | Continuous                                  | 275 Amps               |
|                       | Intermittent                                | 455 Amps (5 minutes)   |
|                       | Cranking                                    | 1250 Amps (10 seconds) |
| Max. Voltage          | 48V DC                                      |                        |

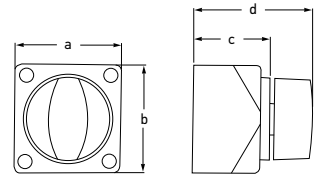

#### Dimensions

a = 68mm / 2.72"  
b = 68mm / 2.72"  
c = 48mm / 1.90"  
d = 75mm / 2.93"

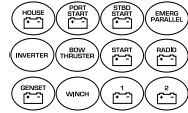

### 600 Amp Battery Master Switch

Contour Lock system with removable plates allows the switch to be a stand alone unit or locked together with other switches. The control knob cannot be removed whilst in an ON or OFF position, however, it can be removed by switching to an anti-clockwise 45° position. Suitable for surface or recess mounting by cutting a 85mm diameter hole.



#### Part Number

4720 (6EK 998 540-062)

|                       |   |                        |
|-----------------------|---|------------------------|
| Housing Material      | Impact resistant plastic. Tin plated studs. |                        |
| Termination Stud Size | 2 x 12mm (1/2")                             |                        |
| Operation             | ON / OFF                                    |                        |
| Protection            | IP56  |                        |
| Max. Load 12 / 24V DC | Continuous                                  | 600 Amps               |
|                       | Intermittent                                | 800 Amps (5 minutes)   |
|                       | Cranking                                    | 2500 Amps (10 seconds) |
| Max. Voltage          | 48V DC                                      |                        |

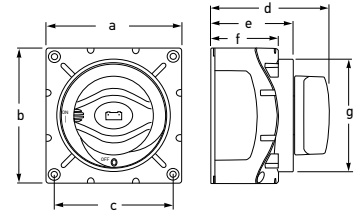

#### Dimensions

a = 102mm / 4.02" e = 62mm / 2.45"  
b = 102mm / 4.02" f = 51mm / 2.01"  
c = 89mm / 3.51" g = 85mm / 3.35"  
d = 90mm / 3.55"

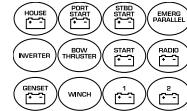

### 350 Amp Battery Selector Switch

Contour Lock system with removable plates for connection from all sides. This allows the switch to be a stand alone unit or locked together with battery distribution modules. Necessary for on board systems fed from 2 or more batteries and whose supply comes from more than 1 generator. Rotary switch in 4 switch positions of battery 1-2-Both-OFF. Switch can also be pad locked. Suitable for surface or recess mounting by cutting an 85mm diameter hole.



#### Part Number

4721 (6EB 998 540-202)

|                       |   |                        |
|-----------------------|---|------------------------|
| Housing Material      | Impact resistant plastic. Tin plated studs. |                        |
| Termination Stud Size | 3 x 10mm (3/4")                             |                        |
| Operation             | 1-2-Both-OFF                                |                        |
| Protection            | IP56  |                        |
| Max. Load 12 / 24V DC | Continuous                                  | 350 Amps - B1 or B2    |
|                       | Continuous                                  | 500 Amps - B1 and B2   |
|                       | Intermittent                                | 500 Amps (5 minutes)   |
|                       | Cranking                                    | 1500 Amps (10 seconds) |
| Max. Voltage          | 48V DC                                      |                        |

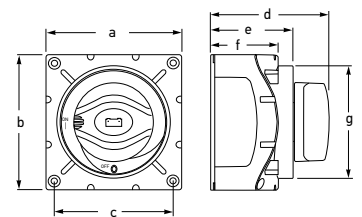

#### Dimensions

a = 102mm / 4.02" e = 62mm / 2.45"  
b = 102mm / 4.02" f = 51mm / 2.01"  
c = 89mm / 3.51" g = 85mm / 3.35"  
d = 90mm / 3.55"

## Battery Master Switches

These heavy duty battery switches are perfect for switch 100/150A depending on the model. They offer a removable key, which can be removed in the OFF position, when the current is interrupted. This ensures that loads cannot be applied accidentally. Positive or negative cable can be switched as required.

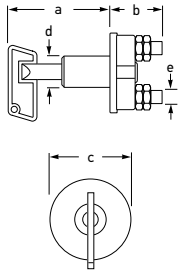

### Dimensions

a = 66mm / 2.60"  
 b = 40mm / 2.58"  
 c = 57mm / 2.25"  
 d = 22mm / 0.87"  
 e = 10mm / 0.40"

### 150 Amp Battery Master Switch

| Part Number            | Spare Key Number                |
|------------------------|---------------------------------|
| 6EK 002 843-051 (4650) | 4652 (9SL 706 729-012)          |
| Housing Material       | Impact resistant plastic        |
| Cable Connection       | 2 screw terminals, M10          |
| Protection             | IPX4                            |
| Max load - Continuous  | 150A                            |
| Max load - 10s         | 500A (Compliant with VDA 72750) |

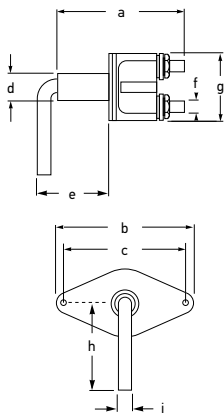

### Dimensions

e = 62mm / 2.45"  
 a = 109mm / 4.30" f = 10mm / 0.40"  
 b = 120mm / 4.73" g = 58mm / 2.29"  
 c = 100mm / 4.94" h = 75mm / 2.96"  
 d = 22mm / 0.87" i = 10mm / 0.40"

### 100 Amp Battery Master Switch

| Part Number            | Spare Key Number                 |
|------------------------|----------------------------------|
| 6EK 001 559-001 (4653) | 4654 (9SL 042 991-002)           |
| Housing Material       | Steel key and mounting plate     |
| Cable Connection       | 2 screw terminals, M10           |
| Protection             | IPX4                             |
| Max load - Continuous  | 100A                             |
| Max load - 10s         | 2500A (Compliant with VDA 72750) |

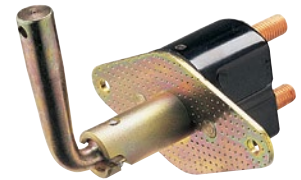

## Voltage Sensitive Relay\*

"Dual battery charging made easy", the Voltage Sensitive Relay (VSR) allows two batteries to be charged at the same time.

When the engine is started and the start battery reaches 13.7 volts, the VSR engages, allowing two battery banks (start and auxiliary) to be charged simultaneously.

When the voltage drops below 12.8 volts (e.g. the engine is stopped), the VSR disengages, separating the batteries. This system eliminates the possibility of draining the start battery and protects sensitive electronic equipment powered from the auxiliary battery from harmful engine start up spikes.

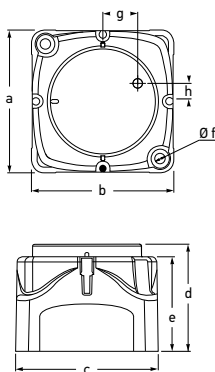

### Dimensions

a = 68mm / 2.68"  
 b = 68mm / 2.68"  
 c = 68mm / 2.68"  
 d = 51mm / 2.01"  
 e = 45mm / 1.78"  
 f = Ø5.20mm / 0.20"  
 g = 17mm / 0.67"  
 h = 9mm / 3.36"

| Part Number            |   |
|------------------------|---|
| 3099 (4RD 980 830-001) |   |
| Housing Material       | Impact resistant plastic. Copper studs. |
| Termination Stud Size  | 2 x 6mm (1/4")                          |
| Protection             | IP56                                    |
| Voltage                | 12V DC                                  |
| Max. Load 12 DC        | 140 Amps                                |
| Dimensions             | 68 x 68 x 50mm (W x D x H)              |

\*Not available in all markets



## 2 Group Light Dimmer

The 2 Group LED Dimmer provides precise dimming control for one or two separate light groups, via PWM technology. Please check the specific lamp suitability to this type of dimming.

The dimmers low voltage protection also protects against deep battery discharge. Lights will turn off automatically when battery voltage is lower than 9V on a 12V system or lower than 18V on a 24V system.

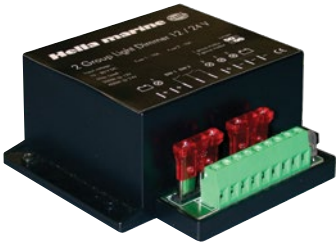

### Part Number

5XA 998 572-001

|                     |                                    |
|---------------------|------------------------------------|
| Max. Load           | 200W at 12V and 400W at 24V        |
| Max. Load Per Group | 100W at 12V and 200W at 24V        |
| Input Voltage Range | 8 – 30V DC                         |
| System Voltage      | 12V or 24V DC                      |
| Number of Groups    | 2                                  |
| Switches Per Group  | Unlimited                          |
| Switch Type         | Momentary normally open            |
| Weight              | 140 grams                          |
| Protection          | Overload, Temperature, Low voltage |
| Fuse                | 2 x 10A                            |
| PWM Frequency       | 400Hz                              |

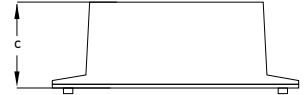
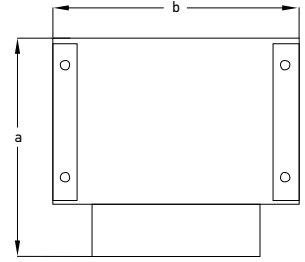

### Dimensions

a = 89mm / 3.51"  
b = 99mm / 3.90"  
c = 41mm / 1.62"

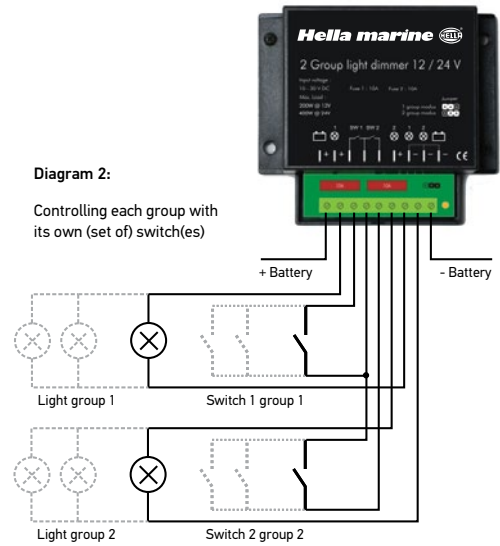
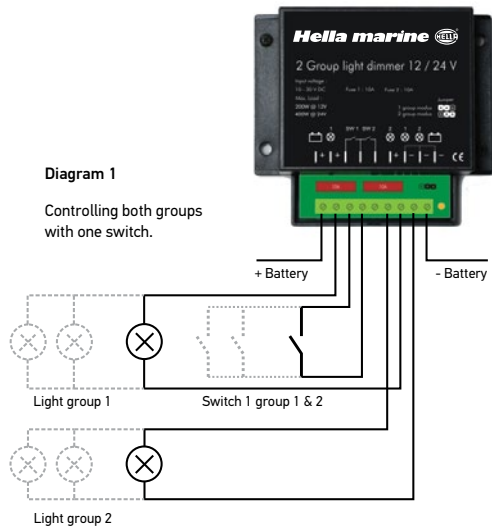

# Stainless Steel LED Switches

Attractive stainless steel switches featuring an appealing ring of LED light. Manufactured from 304 stainless steel, these through panel mount switches are IP67 rated when installed and ideal for switching lighting or installing into custom switch panels.

The light rings may be wired to show power to a system or signal circuit activation. The range also includes matching stainless steel warning buzzers with LED light rings.

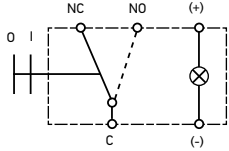
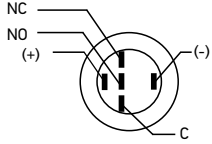

Switch

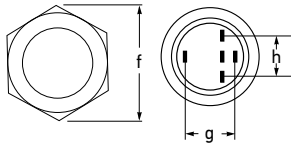
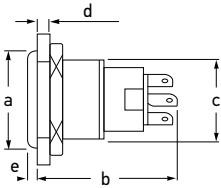

**Dimensions**

- a = 22mm / 0.87"
- b = 37mm / 1.46"
- c = M19x1 / 0.75"
- d = 10mm / 0.40" Max
- e = 2mm / 0.08"
- f = 25mm / 0.99"
- g = 12mm / 0.48"
- h = 10mm / 0.40"

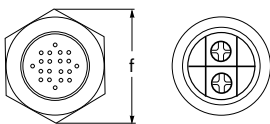
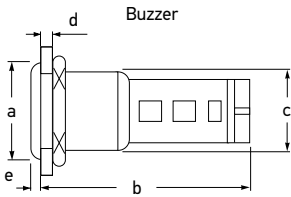

**Dimensions**

- a = 22mm / 0.87"
- b = 53.6mm / 2.12"
- c = M19x1 / 0.75"
- d = 10mm / 0.40" Max
- e = 2mm / 0.08"
- f = 25mm / 0.99"

**Latching Switches with LED Ring**

| Light Colour | Voltage | Operation | Part Number     |
|--------------|---------|-----------|-----------------|
| Red          | 12V DC  | On / Off  | 8HG 958 455-001 |
| Blue         | 12V DC  | On / Off  | 8HG 958 455-011 |
| Red          | 24V DC  | On / Off  | 8HG 958 455-101 |
| Blue         | 24V DC  | On / Off  | 8HG 958 455-111 |



**Momentary Switches with LED Ring**

| Light Colour | Voltage | Operation | Part Number     |
|--------------|---------|-----------|-----------------|
| Red          | 12V DC  | Momentary | 8HG 958 455-201 |
| Blue         | 12V DC  | Momentary | 8HG 958 455-211 |
| Red          | 24V DC  | Momentary | 8HG 958 455-301 |
| Blue         | 24V DC  | Momentary | 8HG 958 455-311 |



**Buzzers with LED Ring**

| Light Colour | Voltage | Operation | Part Number     |
|--------------|---------|-----------|-----------------|
| Red          | 12V DC  | Buzzer    | 8HG 958 456-001 |
| Red          | 24V DC  | Buzzer    | 8HG 958 456-101 |



|                        |  |
|------------------------|--|
| Body Material          | 304 Stainless Steel  |
| Contact Material       | Silver Alloy   |
| Terminal Type          | 5 Pin (2.8 x 0.5mm) switches<br>2 screws for buzzer            |
| Panel Thickness        | 1 – 10mm   |
| Operating Temp         | -20°C – +55°C  |
| Insulation Resistance  | ≥1000mΩ  |
| Contact Resistance     | ≤50mΩ  |
| Max. Switch Rating     | 5A   |
| Protection             | IP65 for switches (Front only)<br>IP50 for buzzer (Front only) |
| Buzzer sound intensity | >80dB (1m)   |

| Accessory                  | Part Number     |
|----------------------------|-----------------|
| Marine Switch Pigtail Loom | 8KB 990 258-021 |



## Water Resistant Plug and Socket

Add power to where you need it in exposed places of the vessel. Perfect for plugging in fishing reels. Cap supplied to cover when not in use.



Metal Plug & Socket suitable for cable up to 6.5mm diameter.

| Description | Pin   | Material     | Part Number            |
|-------------|-------|--------------|------------------------|
| Socket      | 2 Pin | Chrome Brass | 2741 (8JB 950 987-001) |
| Plug        | 2 Pin | Chrome Brass | 2742 (8JB 950 988-001) |

|                      |                                      |
|----------------------|--------------------------------------|
| Plug Socket Type     | Chrome Brass                         |
| Material Description | Chrome brass housings Brass contacts |
| Maximum Load         | 10A @ 12V                            |
| Installation         | Screw terminals                      |

# Quick Reference Technical Advantages



#### Multivolt™

Can be connected to either 12 or 24 volt DC electrical systems.



#### Heavy Duty Grilamid® Lens

A revolutionary transparent plastic with exceptionally high impact strength and resistance to UV and chemical damage.



#### IP67 - Completely Sealed

Preventing moisture from corroding electronics is vital for long term durability. Hella marine products are completely sealed for interior or exterior use, wet or dry.



#### Corrosion Resistant

For the ultimate in longevity under salt water conditions.



#### IP6K9K - Completely Sealed

Protection from dust and high-pressure/steam jet cleaning.



#### Dual Colour

Dual colour lamps offering a selection of White light, paired with either night vision preserving red light, or a cool blue aesthetic.



#### Outstanding UV Resistance

Advanced UV resistant polymers that will not yellow or deteriorate in the harshest marine conditions.



#### Heavy Duty Mount

Designed for heavy duty mounting.



#### CE

The Conformité Européene (CE) Mark is defined as the European Union's (EU) mandatory conformity marking for regulating the goods sold within the European Economic Area (EEA) since 1985.



#### Edge Light

Use your lights more. Edge light enhances utility by having a low power operating mode for ambient lighting requirements. This lighting won't affect batteries but creates a visual difference when anchored or cruising.

# Hella marine Warranty

## Standing behind our product

All HELLA LED based lighting products, supplied by Hella marine, carry a Five-Year Warranty from end user purchase covering faults in materials, components or workmanship, and provided that the product is installed in accordance with our mounting instructions and by suitable qualified personnel with the exceptions as stated below:

- **NaviLED TRIO Tri Colour LED navigation lamps carry a 7-Year Warranty.**
- **Apelo Underwater Lights carry a 3-year Warranty.**
- **Bulb-based lamps and products in the accessories section come with a 1-year manufacturer's warranty**

This warranty is in addition to and does not preclude any other rights or remedies available to the consumer under any local legislation related to the provision of goods or services.

In the unlikely event that you should experience a confirmed warranty with a HELLA product, we will at our discretion, either repair or replace the product or refund the purchase price.

Warranty services may be obtained by returning the product within the warranty period to the HELLA Dealer where the product was originally purchased.

### **This warranty does not cover:**

1. Claim/s as a result of normal wear and tear or of any modifications and / or alterations to the product in any shape or form.
2. Claim/s as a result of non-compliance of the assembly, service and operating instructions and/or any unfit or improper use and /or wrong or negligent treatment, and /or normal wear and tear, contamination, results from accidents, insufficient or excessive electrical supply, subject to undue environmental conditions, accident or improper application.
3. Any expenses incurred in the process of making the claim.

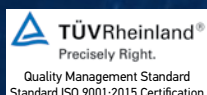



# WORLD LEADING MARINE LIGHTING

Excellence Assured



# APELO LIGHT CONTROLLER

DISCOVER A WORLD OF COLOUR



S-HMAU2026 V01



Wirelessly group, manage, and sync Apelo RGB lighting for vibrant colour displays, using the Apelo Controller & App.



iPhone and App Store are registered trademarks of Apple Inc.  
Google Play is a registered trademark of Google Inc.



**Hella marine Australia**  
HELLA Australia Pty Ltd  
15D Chifley Drive  
Moorabbin Airport, Victoria 3194 Australia

Phone 1800 061 729  
Email [hellaorders@hella.com](mailto:hellaorders@hella.com)  
[info.au@hella.com](mailto:info.au@hella.com)



Scan the QR code for an Australian distributor near you.  
For distributors in other regions, please contact [info@hellamarine.com](mailto:info@hellamarine.com)



[www.hellamarine.com](http://www.hellamarine.com)