



BRIEF INFORMATION

LED MULTI-FUNCTION LIGHT – DURALED

- Rectangular LED light for horizontal mounting
- Multivolt: 8–28 V, as well as 12 / 24 V
- Long design life with low current consumption

PRODUCT FEATURES

LED lighting technology

Homogenous illumination and an excellent signalling effect is achieved at a very low level of power consumption by combining efficient light-emitting diodes (LEDs) and precision optics. LED lights from HELLA are fully sealed and maintenance-free!

Long design life with low current consumption

Thanks to innovative LED technology and good thermal management, the light is able to achieve a long design life. Low energy consumption and no maintenance costs ("fit and forget") make this product the perfect environmentally friendly light.

Indicator failure check

Thanks to the system patented by HELLA for monitoring indicators, this 959 050-401 light can be used in accordance with requirement ECE-R48.

Overvoltage protection

Overvoltage protection ensures that the lights are not damaged even with voltage peaks acc. to ISO 7637.

Excellent water resistance

Testing in accordance with IP 6K6 / IP 6K7 and IP 6K9K ensures the lights are completely water-resistant.

Polarity reversal protection

The light does not suffer any damage if the poles are connected incorrectly.

LED LIGHTING TECHNOLOGY

Extremely low energy consumption

Thanks to the combination of efficient light-emitting diodes (LEDs) and precision optics, HELLA signal lights achieve the light distribution level specified by law – and with 70 % less power consumption compared with bulb lighting!

No change of light source, no maintenance and an extremely long operating life thanks to good thermal management

To extend the design life of the light, all the components are perfectly attuned to one another's temperatures. This prevents LED overload in the event of high ambient temperatures. These products are built for durability over the vehicle's service life through the use of quality LEDs and good thermal management. This makes them an impressive, economical and environmentally friendly "fit-and-forget" solution.

LED Multivolt technology

Multivolt circuits stabilise the light output over a voltage range of 9 to 33 volts. This allows the same HELLA signal light to be used for both 12 and 24 V applications. Multivolt also compensates for voltage fluctuations which arise through the use of long cables and plug-type connections within the vehicle electric system. In addition, HELLA Multivolt circuits are protected from polarity reversal and voltage peaks – even at low battery voltages.

Indicator failure check

The indicator function is monitored by the electronics system, which generates current pulses for the direction indicator input at defined points in time. For every flashing pulse, the upstream flasher in the vehicle electric system expects to receive this pulse after 100 ms – for at least 107 ms. If components or LEDs of the indicator function are defective, this is detected by the electronics:

no pulse is sent. Therefore, the driver is definitively informed of the indicator failure. This fulfils the legal requirement for indicator failure detection (in accordance with the ECE regulation).

The following three ballasts are suitable for almost any application:

5DS 009 552- ...







5DS 009 602- ...

4DW 009 492- ...

APPLICATION EXAMPLE



TECHNICAL DETAILS

Technical data	959 050-40	980 603-50	980 615-00
Type approval	ECE  10176, GGVS/ADR	ECE  5870, GGVS/ADR	ECE  5870, GGVS/ADR
Functions	Brake light: 24 red LEDs Rear light: 8 red LEDs Indicator: 16 yellow LEDs	Rear light/brake light: 12 red LEDs Indicator: 12 yellow LEDs Reversing light: 6 white LEDs	Rear light/brake light: 12 red LEDs Indicator: 12 yellow LEDs Reversing light: 6 white LEDs
Failure check	self-monitoring integrated in the indicator	Not available	Not available
Specification	HELLA standard 67001 Class 10	HELLA standard 67101 Class 2.2, 5.1, 6.1, 7.2, 8.1, 11.2	HELLA standard 67101 Class 2.2, 5.1, 6.1, 7.2, 8.1, 11.2
Current consumption	Brake light: 5 W Rear light: 1.5 W Indicator: 3 W	Rear light: 1 W Brake light: 5 W Indicator: 4 W Reversing light: 3 W	Rear light: 1 W Brake light: 5 W Indicator: 4 W Reversing light: 3 W
Operating voltage	8–28 V DC	12 V/ 24 V DC	12 V/ 24 V DC
Overvoltage protection	5000 W TVS (according to ISO 7637)	5000 W TVS (according to ISO 7637 and ISO 16750-2)	5000 W TVS (according to ISO 7637 and ISO 16750-2)
Polarity reversal protection	Yes (up to 1000 V)	Yes (up to 1000 V)	Yes (up to 1000 V)
Operating temperature	-40 °C to +60 °C	-40 °C to +60 °C	-40 °C to +60 °C
Protection class	IP 6K6 / IP 6K7	IP 6K6 / IP 6K7	IP 6K7 / IP6K9K
EMC approval	 03 1586	 10 R – 04 0958	 10 R – 04 0958
Design life*	As per design life of vehicle*	As per design life of vehicle*	As per design life of vehicle*
Fixing	2 holes for screw attachment Ø 5.8 mm	2 holes for screw attachment Ø 5.8 mm	2 holes for screw attachment Ø 5.8 mm

*Depending on ambient temperature

Technical drawing

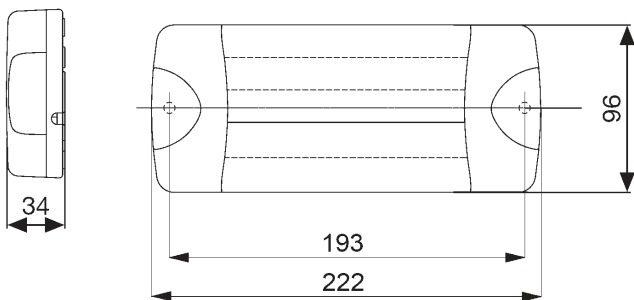

Pin assignment

Pin assignment	980 615-00
Pin 1	Rear light
Pin 2	Brake light
Pin 3	Indicator
Pin 4	Reversing light
Pin 5	Earth
Pin 6	Position light

Wire colours

	959 050-40	980 603-50
Minus (-)	white	white
Brake light	red	red
Rear light	brown	brown
Indicator	blue	green
Reversing light	-	pink

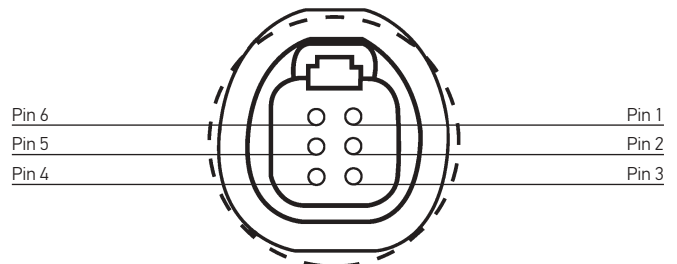





HELLA Limited

Wildmere Industrial Estate
Banbury, Oxon OX16 3JU
Tel.: (01295) 225600
Fax: 0800 7832571
E-mail: hella.sales@hella.com
Website: www.hella.co.uk

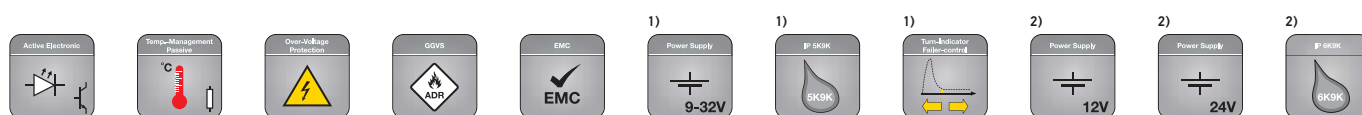
© HELLA KGaA Hueck & Co., Lippstadt,
922 999 134-485 J00687/KB/09.13/0.3
Subject to technical and price modifications
Printed in Germany

RANGE OVERVIEW



Product image	Part number	Specification	Type approval	PU
	2SD 959 050-401 ¹⁾	Rear light/brake light/indicator for horizontal and vertical mounting, clear glass lens, 2500 mm cable with stripped ends, 40 LEDs, Multivolt 8-28 V	ECE ^{E24} 10176 E41 03 1586 GGVS/ADR EMV	1
	2SK 980 615-001 ²⁾	Rear light/brake light/indicator/reversing light for horizontal mounting, clear glass lens, painted grey, Deutsch connector, 30 LEDs, 12 V / 24 V	ECE ^{E24} 5870 ECE ^{E24} 10 R - 04 0958 GGVS/ADR EMV	1
	2SK 980 603-503 ²⁾	Rear light/brake light/indicator/reversing light for horizontal mounting, clear glass lens, painted grey, 2500 mm cable, 30 LEDs, 12 V / 24 V	ECE ^{E24} 5870 ECE ^{E24} 10 R - 04 0958 GGVS/ADR EMV	1

The individual light functions may only be operated with a vehicle fuse of max. 3 A.