

Submersible LED Trailer Lamps



Advanced Hella marine LED trailer lamps are the ultra visible, maintenance free solution for reliable and safe boat trailer lighting.

Designed and manufactured in New Zealand, Hella LED trailer lamps are completely sealed and maintenance free. They are also shock, vibration, UV and corrosion resistant and represent true 'fit and forget' technology. Multivolt™ electronics reduce the effect of voltage drop, ensuring ongoing safety. This means Hella LED lamps perform at full brightness across a range of voltages from 8-28V DC, unaffected by voltage drop that can dull bulb lamps due to long cable runs, joins, terminals and plugs in a trailer's wiring.

LED
Multivolt

2379 LED Submersible Rear Combination Lamp

ADR
COMPLIANT

Mounting Designed to be mounted horizontally
Surface mount

Operating Voltage Multivolt™ 8-28V DC

Power Consumption Rear position 1W, Indicator 5W, Stop 5W

Voltage Protection Spike, Over Voltage and Reverse Polarity

Cable Pre-wired with 6m of cable

Approvals ADR compliant

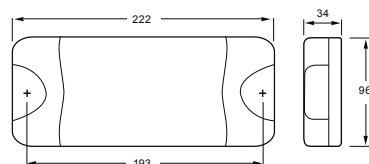

Part Number	Description
2379	Rear Position / Stop / Indicator Lamp

LED
Multivolt

2379 LED Trailer Lighting Pack

ADR
COMPLIANT

Part Number	Description
2379-TP	2 x 2379 Submersible LED Combination Lamps 2 x 2559 LED Number Plate Lamps (with mounting spacers) 2 x Red Reflex Reflectors



2379 series lamps feature an Ultra Wide Visibility Optic, significantly improving side visibility. Hella's use of ultra wide visibility optics far exceeds the minimum ECE/ADR requirements and provides following vehicles with higher light intensity and vehicle recognition, especially as vehicles turn on curves and corners.

LED
Dualvolt

2399 LED Submersible Rear Combination Lamp

ADR
COMPLIANT

Mounting Single Bolt, optional Red Reflex Reflector Base

Operating Voltage Dualvolt 12-24V DC

Power Consumption Rear position 1W, Indicator 3W, Stop 3W

Voltage Protection Spike, Over Voltage and Reverse Polarity

Cable Pre-wired with 2.5m of cable

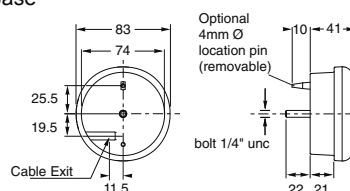

Part Number	Description
2399BL	Single Rear Position / Stop / Indicator Lamp
2399	Pair of Rear Position / Stop / Indicator Lamps

Red Reflector Bases to suit 2399 lamps

Part Number	Description
2934-H	Horizontal Mount
2934-V	Vertical Mount

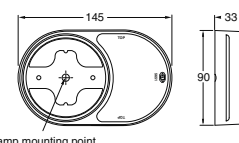

2934H

LED
Dualvolt

2399 LED Trailer Lighting Pack

ADR
COMPLIANT

Part Number	Description
2399-TP	2 x 2399 Submersible LED Combination Lamps 2 x 2559 LED Number Plate Lamps (with mounting spacers) 2 x 2934H Red Reflex Reflector Bases - Horizontal Mount

Submersible LED Trailer Lamps

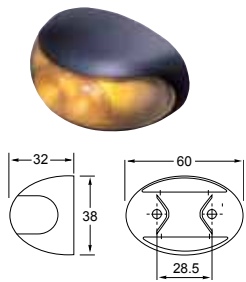

LED
Multivolt

DuraLed Front End Outline Lamp

ADR
COMPLIANT

Product Description
Operating Voltage
Installation

Amber Front End Outline (FEOL) LED
Multivolt™ 8-28V DC
Pre-wired with 500mm of cable.
Bulk packs pre-wired with 2.5m or 5.0m of cable

Part Number
2051
2051BULK

Pack Size and Description
Single Pack (500mm of cable)
Pack of 4 (2.5m of cable)

LED
Multivolt

DuraLed Side Marker Lamp

ADR
COMPLIANT



Product Description
Operating Voltage
Installation

Red / Amber Side Marker LED Lamp
Multivolt™ 8-28V DC
Pre-wired with 500mm of cable.
Bulk pack pre-wired with 2.5m of cable
Super Seal version has 150mm of cable terminated with a Super Seal Connector

Part Number
2053
2053BULK
2053SBULK

Pack Size and Description
Single Pack (500mm of cable)
Pack of 4 (2.5m of cable / no SS)
Delphi connector and short pigtail loom (2.5m of cable)

LED
Multivolt

DuraLed Front Position / End Outline Lamp

ADR
COMPLIANT

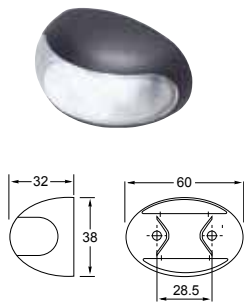

Product Description
Operating Voltage
Installation

White Front End Outline (FEOL) LED
Multivolt™ 10-33V DC
Pre-wired with 500mm of cable.
Bulk pack pre-wired with 2.5m of cable

ECE Compliance

E4 02 7575

Part Number
2054
2054BULK

Pack Size and Description
Single Pack (500mm of cable)
Pack of 4 (2.5m of cable)

LED
Multivolt

LED Number Plate Lamp

ADR
COMPLIANT



2559BULK

Voltage
Cable

LED Multivolt™ 10-33V DC
Pre-wired with 2.5m of cable

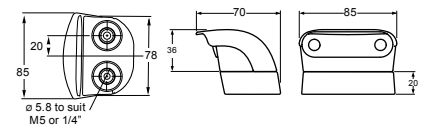

Part Number
2559
2559BULK

Pack Size and Description
LED Number Plate Lamp
Pack of 8 with mounting spacer

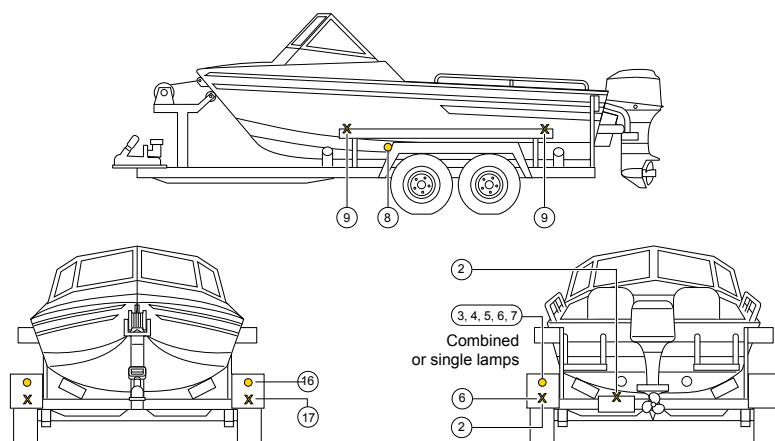

No. Lamp Function

2	License Plate Lamps	ADR 48/00
3	Rear Direction Indicator Lamps	ADR 6/00 Cat.2
4	Rear Position Lamps	ADR 49/00
5	Stop Lamps	ADR 49/00
6	Rear Reflex Reflectors	ADR 47/00
7	Reversing Lamps	ADR 1/00
8	Side Reflex Reflectors	ADR 47/00
9	Side Marker Lamps	ADR 45/01 or ADR 74/00
16	Front Position Lamps	ADR 49/00
17	Front Reflex Reflectors	ADR 47/00

Trailer Plugs and Sockets

**7 Pole Plastic Plug**

Maximum Load	20A @ 12V 10A @ 24V
---------------------	------------------------

7 Pole Plastic Plug

Part Number	Pack Size
4902	Single Pack

**7 Pole Plastic Socket**

Maximum Load	20A @ 12V 10A @ 24V
---------------------	------------------------

7 Pole Plastic Socket

Part Number	Pack Size
4912	Single Pack

**7 Pole Metal Plug**

Maximum Load	20A @ 12V 10A @ 24V
---------------------	------------------------

7 Pole Metal Plug

Part Number	Pack Size
4911	Single Pack
4911BULK	Pack of 25

**7 Pole Metal Socket**

Maximum Load	20A @ 12V 10A @ 24V
---------------------	------------------------

7 Pole Metal Socket

Part Number	Pack Size
4901	Single Pack
4901BULK	Pack of 25

**7 Pole Flat Socket**

Impact resistant, UV stabilised, plastic, spring loaded lid.
Nickel contacts for excellent electrical performance.

Maximum Load	20A @ 12V 10A @ 24V
---------------------	------------------------

7 Pole Flat Socket

Part Number	Pack Size
4920	Single Pack

**7 Pole Flat Plug**

Impact resistant, UV stabilised, plastic, spring loaded lid.
Nickel contacts for excellent electrical performance.

Maximum Load	20A @ 12V 10A @ 24V
---------------------	------------------------

7 Pole Flat Plug

Part Number	Pack Size
4921	Single Pack

Trailer Plugs and Sockets



Trailer Plug Holder

Minimises potential damage to plug

Mounting

Screw mounting on trailer drawbar or any convenient location.

Trailer Plug Holder

Part Number	Pack Size
8000	Single Pack



Flat Plug Holder

Flat plug holder to suit 7 Pole Flat Plug (Part Number 4921)

Flat Plug Holder

Part Number	Pack Size
8009	Single Pack
8009BULK	Pack of 20



Trailer Socket Bracket

Zinc steel. Eliminates the need to drill vehicle.

Trailer Socket Bracket

Part Number	Pack Size
8022	Single Pack

7 Pole Connector Wiring Specification

Terminal No.	Connect to	Colour
1	Left flasher lamps	Yellow
2	Reversing lamps	Black
3	Earth	White
4	Right flasher lamps	Green
5	Service brakes (auxiliary) *	Blue
6	Stop lamps	Red
7	Tail, licence plate and clearance lamps	Brown

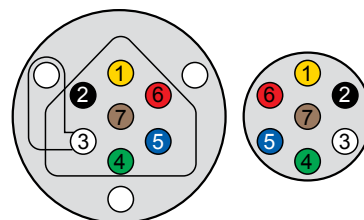

7 Pole Socket

7 Pole Plug

Note: If a separate earth cable is not used on the vehicle, the earthing strip supplied should be fitted into pin 3 of socket and under mounting screw

* Where service brakes are not fitted, terminal No. 5 may be used for auxiliaries.